



INSTRUCTION MANUAL

MARINE RADAR MR-1010R II



SYSTEM COMPONENTS

MODEL NAME	DISPLAY UNIT	SCANNER UNIT
MR-1010RII	10.4-inch Color LCD	EX-2714 (Radome type)

SUPPLIED ACCESSORIES

10.4-inch Color LCD display unit	Quantity
1. NMEA connector (PLT-167-P-R)	1
2. NMEA connector (PLT-168-P-R)	1
3. Spare fuse (FGB 15 A, for 12 V DC)	1
4. Spare fuse (FGB 5 A, for 24 V DC)	1
5. DC power cable	1
6. Mounting bracket	1
7. Mounting knob bolts	2
8. Installation bolts (M6×30)	5
9. Installation nuts (M6)	5
10. Spring washers (M6)	10
11. Flat washers (M6)	10
12. Ferrite EMI filter	1

Scanner unit (EX-2714)	Quantity
1. System cable (15 m)	1
2. Installation bolts (M10×50)	4
3. Installation bolts (M10×25)	4
4. Installation nuts (M10)	4
5. Flat washers (M10)	4
6. Spring washers (M10)	4

① Some accessories are not supplied, depending on the radar version.

DISPOSAL



The crossed-out wheeled-bin symbol on your product, literature, or packaging reminds you that in the European Union, all electrical and electronic products, batteries, and accumulators (rechargeable batteries) must be taken to designated collection locations at the end of their working life. Do not dispose of these products as unsorted municipal waste. Dispose of them according to the laws in your area.

ABOUT CE AND DOC



Hereby, Icom Inc. declares that the versions of MR-1010RII which have the “CE” symbol on the product, comply with the essential requirements of the Radio Equipment Directive, 2014/53/EU, and the restriction of the use of certain hazardous substances in electrical and electronic equipment Directive, 2011/65/EU. The full text of the EU declaration of conformity is available at the following internet address:
<https://www.icomjapan.com/support/>

The MR-1010RII is a supplemental aid to navigation and is not intended to be a substitute for accurate and current nautical charts.

Thank you for choosing this Icom product. The MR-1010RII MARINE RADAR is designed and built with Icom's state of the art technology and craftsmanship. With proper care, this product should provide you with years of trouble-free operation.

IMPORTANT

READ ALL INSTRUCTIONS carefully and completely before using the radar.

SAVE THIS INSTRUCTION MANUAL—
This manual contains important safety and operating instructions for the MR-1010RII.

FEATURES

The radar is "Made in Japan." It has powerful transmitting power for long range detection, a 10.4-inch wider view angle color display, simplified ARPA to detect up to 5 targets, and other advanced features.

EXPLICIT DEFINITIONS

WORD	DEFINITION
⚠ DANGER!	Personal death, serious injury or an explosion may occur.
⚠ WARNING!	Personal injury, fire hazard, or electric shock may occur.
CAUTION	Equipment damage may occur.
NOTE	Recommended for optimum use. No risk of personal injury, fire or electric shock.

Icom is not responsible for the destruction, damage to, or performance of any Icom or non-Icom equipment, if the malfunction is because of:

- Force majeure, including, but not limited to, fires, earthquakes, storms, floods, lightning, other natural disasters, disturbances, riots, war, or radioactive contamination.
- The use of Icom marine radar with any equipment that is not manufactured or approved by Icom.

BE CAREFUL!

SART signals may not be detected and displayed on the screen, depending on the SEA, RAIN or IR settings.

Make the settings below to detect the SART signals on the screen.

1. Set the screen range to between 6 NM and 12 NM with [+/-]. (pp. 1, 7)
2. Set the [GAIN] as high as possible. (pp. 2, 9)
3. Set [SEA] to minimum. (pp. 2, 9)
4. Set [RAIN] to minimum. (pp. 2, 9)
5. Turn OFF the Interference rejection (IR) function. (p. 10)
6. Turn OFF the Echo Stretch function. (p. 11)

Icom and the Icom logo are registered trademarks of Icom Incorporated (Japan) in Japan, the United States, the United Kingdom, Germany, France, Spain, Russia, Australia, New Zealand, and/or other countries.

All other products or brands are registered trademarks or trademarks of their respective holders.

PRECAUTIONS

For Display unit:

⚠ **WARNING! NEVER** let metal, wire or other objects contact the inside of the display unit, or make incorrect contact with connectors on the rear panel. This could cause an electric shock or damage the display unit.

⚠ **WARNING! NEVER** apply AC voltage to the DC connector of the display unit. This could cause a fire or damage the display unit.

⚠ **WARNING! NEVER** apply more than 42 V DC to the DC connector of the display unit. This could cause a fire or damage the display unit.

⚠ **WARNING! NEVER** touch or operate the display unit with wet hands. This could cause an electric shock or damage the display unit.

⚠ **WARNING! NEVER** open the display unit. There are no user adjustment points. This could cause an electric shock and incorrect reassembly may cause a fire hazard.

⚠ **WARNING! NEVER** operate the radar during a lightning storm. It may result in an electric shock, cause a fire or damage the display unit. Always disconnect the power source and scanner unit before a storm.

⚠ **WARNING! NEVER** reverse the DC power cable polarity. This could cause a fire or damage the display unit.

⚠ **WARNING! NEVER** remove the fuse holder on the DC power cable. Excessive current caused by a short could cause a fire or damage the display unit.

CAUTION: DO NOT use or place the display unit in areas with temperature below -15°C ($+5^{\circ}\text{F}$) or above $+55^{\circ}\text{C}$ ($+131^{\circ}\text{F}$).

CAUTION: DO NOT use harsh solvents such as Benzine or alcohol when cleaning, the display unit, as they will damage the display unit surfaces.

CAUTION: DO NOT place the display unit in excessively dusty environments.

DO NOT place the display unit near heating equipment or in direct sunlight or where hot or cold air blows directly onto it.

DO NOT place the display unit in areas that could block air passage or put anything around the display unit. This will obstruct heat dissipation.

KEEP the display unit out of the reach of unauthorized persons.

KEEP the display unit away from heavy rain, and never immerse it in the water.

The display unit meets IPX4 requirements for splash resistance when the supplied connection cable, scanner unit are connected.

However, if it is dropped, splash resistance cannot be guaranteed because of possible damage to the case or the waterproof seals.

The LCD display may have cosmetic imperfections that appear as small dark or light spots. This is not a malfunction or defect, but a normal characteristic of LCD display.

For Scanner unit:

⚠ **DANGER: HIGH VOLTAGE! NEVER** open the scanner unit. The scanner unit contains high voltage that could be fatal. And there are no user adjustment points. All repairs and adjustments **MUST** be made by a qualified electronics technician at your Marine Navigation Dealer.

For qualified electronics technician only:

⚠ **DANGER: HIGH VOLTAGE!** High voltages of about 3,500 volts are used in the scanner unit. Although prudent measures for safety have been adopted, sufficient care must be taken in the operation, maintenance and adjustment of the scanner unit.

Electric shock of 1,000 volts or more may cause electrocution and death; even an electric shock of only 100 volts may be fatal.

⚠ **DANGER: HIGH VOLTAGE! DO NOT** turn OFF the radar's power and do not reach inside the scanner unit before you have:

- discharged the capacitors by disconnecting the system cable from the radar unit for 5 minutes.
- checked that no electric charges remain inside the device.

Also, it is recommended to wear dry insulated rubber gloves. **NEVER** use both hands simultaneously; keep one hand in your pocket.

⚠ **WARNING: RADIATION HAZARD!**

Radiation emitted from the scanner unit can be harmful, particularly to your eyes. To avoid harmful radiation, turn OFF the radar's power before working on the scanner unit.

DO NOT use or place the scanner unit in areas with temperature below -25°C (-13°F) or above $+70^{\circ}\text{C}$ ($+158^{\circ}\text{F}$).

NEVER immerse the scanner unit in the water.

The scanner unit meets IPX6* requirements for high-pressure water jet resistance.

However, if the scanner unit is dropped, high-pressure water jet resistance cannot be guaranteed because of possible damage to the cases or the waterproof seals.

* Except for the cable connectors. They meet IPX4 requirements while connecting to the radar unit.

TABLE OF CONTENTS

SYSTEM COMPONENTS	i		
SUPPLIED ACCESSORIES	i		
DISPOSAL	i		
ABOUT CE AND DOC	i		
IMPORTANT	ii		
FEATURES	ii		
EXPLICIT DEFINITIONS	ii		
PRECAUTIONS	iii		
1. PANEL DESCRIPTIONS	1		
■ Front panel	1		
■ Screen	3		
2. BASIC OPERATION	7		
■ Turning the Power ON or OFF	7		
■ Basic operation	7		
■ Adjusting brilliance and color	8		
■ Adjusting the screen	9		
■ OFF CENTER function	10		
■ Zoom function	10		
■ Interference Rejection function	10		
■ Echo Stretch function	11		
■ Long pulse function	11		
■ Trail function	12		
■ Power save function	13		
■ Ship speed indication	14		
■ Waypoint indication	14		
■ Bearing settings	15		
3. DISTANCE AND DIRECTION MEASUREMENTS	17		
■ Distance measurement	17		
■ Bearing and Distance measurement	18		
■ Advanced measurements	19		
4. ALARM FUNCTION	21		
■ Setting the Alarm zone	21		
■ Setting Zone alarm type	22		
5. THE SIMPLIFIED ARPA OPERATION	23		
■ ARPA operation	23		
■ Descriptions of ARPA targets	24		
■ ARPA settings	25		
■ Related settings	25		
6. AIS RECEIVER	26		
■ About AIS	26		
■ AIS operation	26		
■ Description of the AIS display	27		
■ AIS settings	29		
■ Related settings	31		
7. OTHER FUNCTIONS	32		
■ Receiving DSC Information	32		
■ TLL function	33		
■ Select the language	34		
■ Simulation mode	34		
■ Antenna rotation speed	35		
■ Timing adjustment	35		
■ Heading adjustment	36		
■ Range selection	37		
■ Save and load settings	37		
■ Resetting	38		
8. MENU SCREEN	39		
■ Operation in the Menu screen	39		
■ Color menu	39		
■ Trail menu	40		
■ Display menu	40		
■ Target menu	41		
■ ARPA menu	41		
■ AIS menu	42		
■ Video menu	43		
■ System menu	44		
■ Initial menu	45		
■ AIS Own menu	46		
■ Status menu	46		
■ Port Monitor menu	46		
■ Scanner Monitor menu	46		
9. BASIC RADAR THEORY	47		
■ Sidelobe echoes	47		
■ Indirect echoes	47		
■ Multiple echoes	48		
■ Minimum range	48		
■ Blind and Shadow sectors	48		
■ Target resolution	49		
10. MAINTENANCE	50		
■ Periodic maintenance	50		
■ Display unit maintenance	50		
■ Scanner unit maintenance	50		
■ Fuse replacement	50		
11. ERROR MESSAGES	51		
■ Error message list	51		
■ AIS error message list	51		
12. SPECIFICATIONS	52		
■ General	52		
■ Display unit	52		
■ Scanner unit (EX-2714)	52		
■ Options	52		
13. EXTERNAL DATA LIST	53		
14. INSTALLATION AND CONNECTIONS	54		
■ Connecting the units	54		
■ Power source requirement	54		
■ Ground connection	54		
■ Installing the display unit	55		
■ Installing the EX-2714 scanner unit	57		
■ Adjusting the settings	58		
■ Installing the UX-252 Video output unit	59		
■ Checking the installation	60		
INDEX	61		
FCC INFORMATION	66		
RADAR OPERATOR WARNING	66		
(Appendices)			
• Display mounting bracket template			
• MR-1010RII OPERATING GUIDE			

Front panel

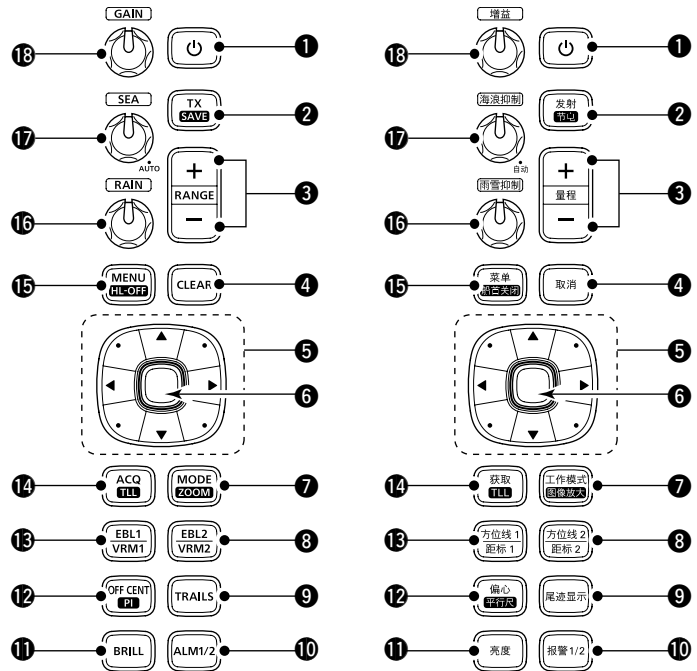
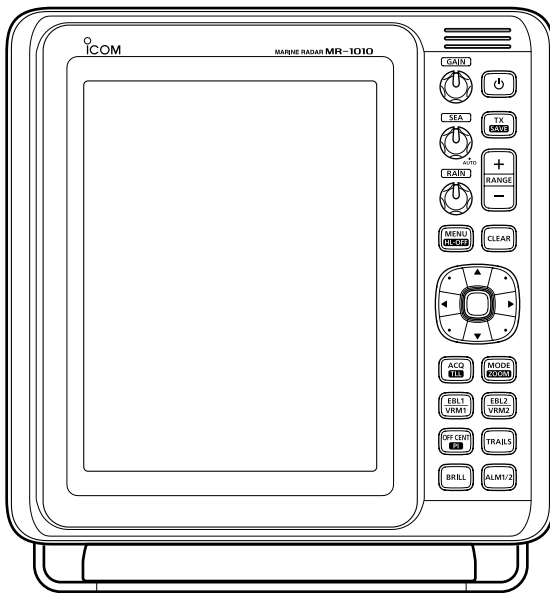

Control panel (English)

Control panel (Chinese)

1 POWER KEY (p. 7)

- Push to turn the radar power ON or OFF.
- The initial screen is displayed and a beep sounds after the power has been turned ON.

2 TRANSMIT/SAVE KEY [TX (SAVE)]/[发射(节电)]

- Push to change the operating mode between TX mode and the standby mode. (p. 7)
- Hold down for 1 second to turn ON the power save function. The radar for the TX interval scan is fixed at 10 revolutions. (p. 13)
- ① Select the save time in the System menu.

3 RANGE UP/ DOWN KEYS [+]/[-] (p. 7)

- Push [+] to increase the screen range.
- Push [-] to decrease the screen range.

4 CLEAR KEY [CLEAR]/[取消]

- Push to cancel the Submenu or Option selection mode in the Menu screen. (p. 39)
- Hold down for 1 second to turn the activated AIS target into a sleeping target. (p. 28)
- ① Hold down [ENTER]/[确认] for 1 second to change the sleeping AIS target to an activated target.
- Hold down for 1 second to release the ARPA target or delete the TLL symbol. (pp. 23, 33)

5 CURSOR PAD

- Push to move the cross-line cursor in sixteen directions in the normal operating mode.
- Sets the EBLs, VRMs, alarm area, ARPA target, AIS target, and so on.
- Push [◀] or [▶] to select the Menu group, or push [▲] or [▼] to select the menu items in the Menu screen. (p. 39)

6 ENTER KEY*

*Described as [ENTER]/[确认] in this manual.

Push to select the target and display the ARPA, AIS, DSC, TLL, or WPT information. (pp. 14, 23, 26, 33)

- In the Menu screen, push to display a submenu or option selection mode, or push to save the settings. (p. 39)
- Hold down for 1 second to turn the sleeping AIS target into an activated target. (p. 26)
- ① Hold down [CLEAR]/[取消] for 1 second to change the activated AIS target to a sleeping target.
- Hold down for 1 second to display the DSC details. (p. 32)

7 MODE / ZOOM KEY [MODE•ZOOM]/[工作模式•图像放大]

- Push to select the screen mode, Head-up (H-UP), Course-up (C-UP), North-up (N-UP) or True motion (TM) screen. (p. 7)
- ① The North-up, and Course-up screens can be selected only when a bearing data input is connected. (pp. 45, 53)
- ① The TM screen requires bearing data and position data.
- ① The TM screen is not selectable in the 32 NM or higher range.
- Hold down for 1 second to select the ZOOM view ON or OFF. The ZOOM view expands the Plain Position Indicator (PPI) and the trail around the cross-line cursor to the double size of the normal view. (p. 10)

8 EBL2 (VRM2) KEY [EBL2 (VRM2)]/

【方位线2(距标2)】 (pp. 17–20)

- Push to display the EBL2 and the VRM2.
EBL: Electronic Bearing Line
VRM: Variable Range Marker
- Push [◀] or [▶] to adjust the EBL selector, or push [▲] or [▼] to adjust the VRM selector. Then push [ENTER]/[确认] to set the point.
- The EBL2 bearing and the VRM2 distance are displayed in the lower right corner of the screen.
- When EBL1 and VRM1 are displayed, the center of the VRM2 is displayed at the intersection point of the EBL1 and the VRM1.

9 TRAILS KEY [TRAILS] / [尾迹显示] (p. 12)

- Push to turn the trail function ON or OFF. This is useful for watching other ship's tracks, and approximate relative speed.
 - ① The Trail settings can be changed in the Trail menu.
- Hold down for 1 second to clear the plotted echoes when the trail function is ON.

10 ALARM KEY [ALM1/2]/[报警1/2] (pp. 21–22)

- Push to select the Alarm function, ALM1, ALM2, ALM1 & ALM2, or OFF.
- Hold down for 1 second to enter the alarm zone setting mode.
 - Push the cursor pad to move the cross cursor to the zone starting point, then hold down [ALM1/2]/[报警1/2] for 1 second. The frame of the entered zone is displayed. Then push the cursor pad to fix the finish point, and then push [ALM1/2]/[报警1/2]. The alarm zone will automatically be formed.

11 BRILLIANCE KEY [BRILL]/[亮度] (p. 8)

- Push to display the Brill/Color setting box.
 - ① The brilliance of the display, the key backlight, and display color can be adjusted in the setting box.
 - ① The brightness of the symbols, characters and illuminations can be independently adjusted in the Color menu.
- Push to increase or decrease the brilliance of the display.
- Hold down for 1 second to select the maximum brilliance.

12 OFF CENTER / PARALLEL INDEX LINE KEY [OFF CENT•PI]/ [偏心•平行尺] (p. 10)

- Push to turn the OFF CENTER function ON or OFF.
 - ① This function is usable in the 24 NM or less ranges.
- Hold down for 1 second to display or clear the parallel index lines. (p.17)

13 EBL1 (VRM1) KEY [EBL1 (VRM1)]/

【方位线1(距标1)】 (pp. 17–20)

- Push to display the EBL1 and the VRM1.
EBL: Electronic Bearing Line
VRM: Variable Range Marker
- Push [◀] or [▶] to adjust the EBL selector, or push [▲] or [▼] to adjust the VRM selector. Then push [ENTER]/[确认] to set the point.
- The EBL1 bearing and the VRM1 distance are displayed in the lower left corner of the screen.
- When the EBL1 and the VRM1 are displayed, the beginning of the EBL2 is displayed at the intersection point of the EBL1 and the VRM1.

14 ACQUIRE TARGET / TLL KEY [ACQ/TLL]/ [获取•TLL]

- Push to acquire an ARPA target on the cursor.
 - ① Hold down [CLEAR]/[取消] for 1 second to release the ARPA target.
- Hold down for 1 second to output the position information where the cursor is placed, to the NMEA output terminals. (p. 23)
 - ① TLL output requires bearing data and position data.
 - ① The target symbol can be displayed, depending on the setting in the "TLL Mode" item of the System menu. (p. 33)

15 MENU KEY [MENU/HL-OFF]/[菜单•船首关闭]

- Push to enter or exit the Menu screen. (p. 39)
- Push [◀] or [▶] to select the Menu groups, or push [▲] or [▼] to select the items.
- While holding down [MENU•HL_OFF]/[菜单•船首关闭], the heading line is temporarily turned OFF. (p.9)
 - ① The rings or other objects can also be turned OFF when the "HL OFF Mode" item in the System menu is set to "All." (p. 44)

16 RAIN CLUTTER CONTROL (RAIN) / [雨雪抑制]

(p. 7, 9)

Eliminates echoes from rain, snow, fog, and so on.

- Rotate the control fully counter clockwise to deactivate the RAIN function.
 - The RAIN icon (☔) disappears.

17 SEA CLUTTER CONTROL (SEA) / [海浪抑制]

(p. 7, 9)

Eliminates echoes from waves in close range.

Reduces the receiver gain for close objects within a radius of approximately 8 nautical miles to eliminate sea clutter.

- Rotate the control fully clockwise to activate the automatic SEA control function.
 - The SEA icon (☪) is displayed in the upper left of the screen.
 - "AUTO" is displayed below the SEA icon (☪) when the automatic control function is active.
 - ① Under normal conditions set the SEA to minimum.
 - ① Use this control with caution when the sea is rough.

18 GAIN CONTROL (GAIN) / [增益] (p. 7, 9)

Adjusts the receiver amplifier gain.

- Rotate clockwise to increase the gain.
 - ① The increased gain may increase screen noise.

■ Screen

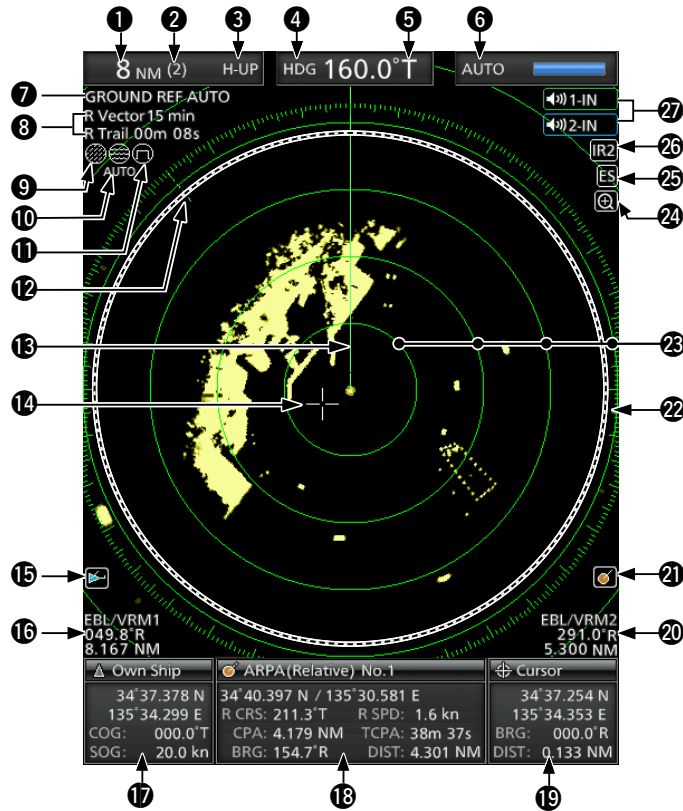

This Display example is set to Wide in the “PPI Area” item of the Display menu.

1 SCREEN RANGE READOUT (p. 17)
Displays the range of the current screen.

Indicator	Description
NM	nautical miles
km	kilometers

① The distance unit can be selected in the Initial menu.

2 FIXED RING RANGE READOUT (p. 17)
Displays the interval range of the fixed ring.

3 MODE INDICATOR (p. 7)
Displays the mode of the display.
Push [MODE•ZOOM]/ [工作模式•图像放大] to select.

Indicator	Description
H-UP	Head-up
C-UP	Course-up
N-UP	North-up
TM	True Motion

① N-UP and C-UP screens require external bearing data.
② The TM screen requires bearing data and position data.

4 HEADING INDICATOR (p. 15)
Displays the heading readout. The HDG readout indicates the bow of the ship’s heading in a clockwise direction from north.

Indicator	Description
HDG	Displayed when the “Bearing Input” in the Initial menu is set to “NMEA,” “N+1,” or “AUX.”
COG	Displayed When the “Bearing Input” item in the Initial menu is set to “GPS” or “GPS-L.”

5 BEARING REFERENCE (p. 15)
Displays the bearing reference.

Indicator	Description
T	True bearing
M	Magnetic bearing

6 TUNING MODE INDICATOR (p. 9)
Displays the tuning mode and the tuning level.

Indicator	Description
Auto	Auto tuning
Manual	Manual tuning

• “TUNE (AUTO)” is displayed when the “TUNE” item in the Video menu is set to “Auto” or “TUNE (MAN)” is displayed when the “TUNE” item is set “Manual.”

7 REFERENCE INDICATOR (p. 15)
Displays the basis of vector reference.

8 TRAILS INDICATOR (p. 12)

- Displays the trail reference and the trail time.
- The echo remains, with gradation, during the period of trail time on the screen. (Except for the trail time: ∞)
- Progressing time counter starts counting until the timer reaches the trail time.

Indicator	Description
T	True
M	Magnetic

9 RAIN CONTROL ICON (p. 9)

Displayed when the RAIN function is used.

10 SEA ICON (p. 9)

Displayed when the SEA control function is used. "AUTO" is displayed below the icon when the automatic SEA control function is used.

11 LONG PULSE ICON (p. 9)

Displayed when the long pulse is used.

12 NORTH MARK

The north mark indicates the true north direction.

13 HEADING LINE (p.16)

The heading line indicates the ships bow direction.

14 CROSS-LINE CURSOR

Used to measure the bearing and distance, setting the alarm zone, selecting the ARPA/AIS targets, and so on.

- The cross-line cursor can be moved to sixteen directions by pushing or holding a cursor pad.

15 AIS ICON (p. 26)

Displayed when a valid VDM sentence is received from the [NMEA1] (AIS) port.

The indicator disappears if the AIS signal is not received for 6 minutes and 40 seconds.

16 EBL1/ VRM1 READOUTS (pp. 17–20)

Displays the bearing of the Electronic Bearing Line (EBL) 1 and the distance of the Variable Range Marker (VRM) 1, when the EBL1 and the VRM1 are used.

- Nautical miles (NM) or kilometers (km) can be selected in the Initial menu as the distance unit in the Initial menu.

17 OWN SHIP INFORMATION

Displays your own ship's latitude and longitude, course, and speed.

- To display the position, NMEA 0183 data is required.
- The speed unit in nautical miles (kn) or kilometers (km/h) can be selected as the speed unit in the Initial menu.

18 INFORMATION BOX (pp. 14, 23, 26, 32)

Displays a detailed information of a selected target, such as AIS, ARPA, TLL, Waypoint, or, DSC.

- Refer to each section in this manual for details on the displayed information in each function.

19 CURSOR INFORMATION

The current position of the cross-line cursor is displayed.

- Latitude and longitude (Lat/Lon) or Time to go (TTG) can be selected as the position format.
- An external NMEA data in 0183 format is required.
- Displays the bearing and distance to the cross-line cursor.

Indicator	Description
R	Relative bearing
T	True bearing
M	Magnetic bearing

- Bearing data and position data are required.

20 EBL2/ VRM2 READOUTS (pp. 17–20)

Displays the bearing of the Electronic Bearing Line (EBL) 2 and the distance of the Variable Range Marker (VRM) 2 when the EBL2 and the VRM2 are set.

- Nautical miles (NM) or kilometers (km) can be selected as the distance unit in the Initial menu.

21 ARPA ICON (p. 23)

Displayed when one or more targets are automatically acquired by auto acquire function.

22 PLAIN POSITION INDICATOR SCOPE AREA

Displays the radar picture and plots the data such as vessels, bases, and so on.

23 FIXED RANGE RINGS (p. 25)

Displays the distance at fixed intervals from the own position. The interval distance is indicated by the ring range readout (2).

- These rings are displayed when the "Ring Brill" item in the Color menu is set to ON (1 to 3).

24 ZOOM ICON (p. 10)

Displayed when the zoomed view is activated.

25 ECHO STRETCH ICON (p. 11)

Displayed when the echo stretch function is used.

26 IR1 / IR2 ICONS (p. 10)

Displayed when the Interference Rejection (IR) function 1 or 2 is turned ON.

27 ALARM1 / ALARM2 ICONS (p. 21–22)

Displayed when the alarm 1 or 2 is set.

■ Screen (Continued)

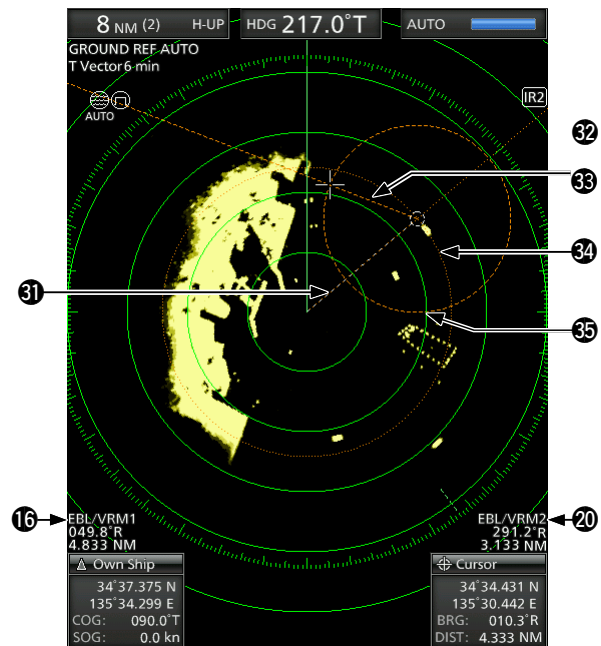
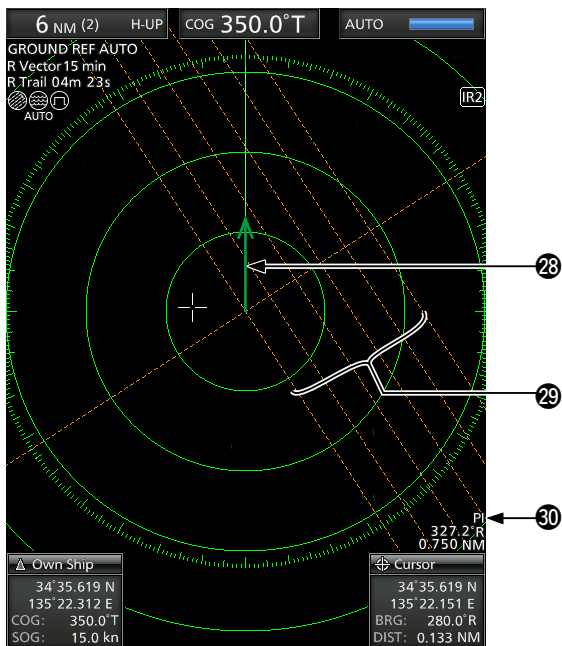

28 OWN SHIP VECTOR INDICATOR (p. 6)

Displays the vector of your own ship.

29 PARALLEL INDEX LINES (p. 17)

Displayed when the Parallel Index line (PI) function is used. Used to measure the direction and interval of the parallel index lines

30 PI READOUTS (p. 17)

Displays the direction and interval of the parallel index lines when the Parallel Index line (PI) function is set.

31 WAYPOINT MARKER (p. 14)

Displays a waypoint that is received from navigation equipment.

- This marker is displayed when the “WPT Display” item in the Display menu is set to ON.
- To display the Waypoint marker, bearing data and NMEA data in 0183 format are required. (p. 53)

32 EBL1 (pp. 17–20)

33 EBL2 (pp. 17–20)

Used to measure bearing.

When a target is selected, the EBL/VRM1 readouts (16) or the EBL/VRM2 readouts (20) display its bearing.

34 VRM1 (pp. 17–20)

35 VRM2 (pp. 17–20)

Used to measure distance.

When a target is selected, the EBL/VRM1 readouts (16) or the EBL/VRM2 readouts (20) display its distance.

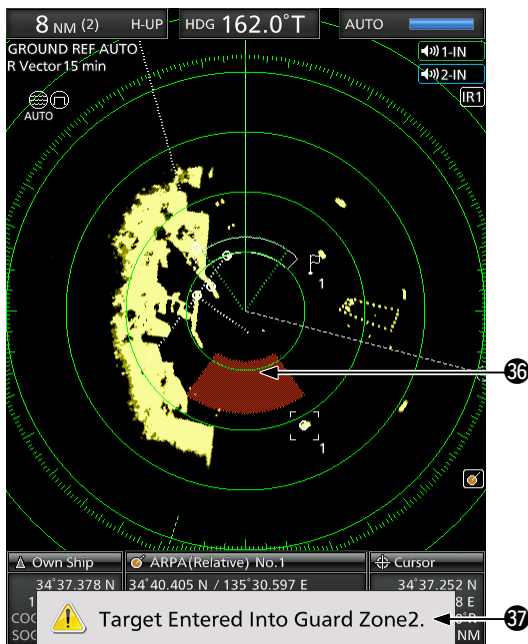

36 ALARM ZONE (p. 14)

- Displays the alarm zone.
- Displays when the alarm function is used.

37 WARNING MESSAGE (p. 22)

- Displayed at the bottom of the screen when an alarm sounds in case such as a vessel is entered into the zone that you have set.
- Push [CLEAR]/[取消] key to stop the alarm sound and close the displayed message.

38 POPUP MESSAGE (p. 32)

- A message pops up when the radar received the data of the target, such as a DSC, or favorite AIS that you have selected.
- Push [Enter]/[确认] to display the details, or push [CLEAR]/[取消] key to stop the alarm sound and close the displayed message.

Turning the Power ON or OFF

Refer to Chapter 14 in this manual about the installation and connections. (pp. 54–60)

Turning ON the power

- Push [⏻] to turn ON the power.
 - The magnetron inside the scanner unit warms up for 90 seconds and the warm-up time is counted down on the screen. When the countdown is completed, the Standby screen is displayed.

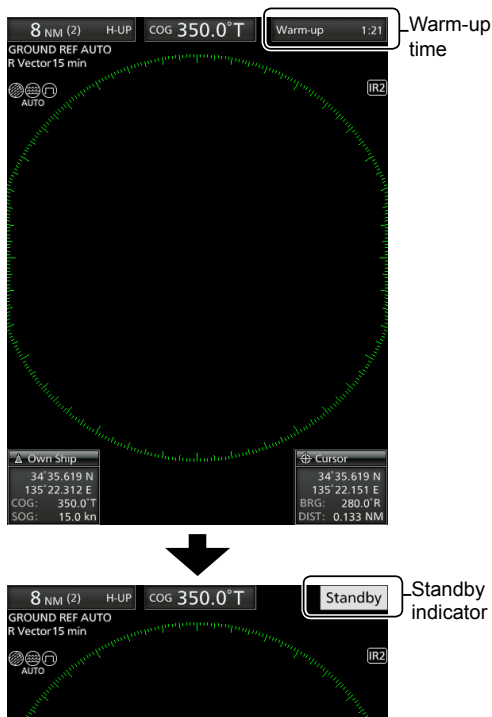

- Push [TX (SAVE)]/[发射(节电)] to start scanning.
 - Targets and heading markers are displayed.
 - The screen is displayed approximately 2 seconds after turning ON the power, when “Auto” is selected in the “TUNE” item of the Video menu.

NOTE: At the first turning ON the MR-1010RII or after performing Factory Reset, the Initial Setting screen is displayed. Push [▲] or [▼] to select a language, and push [ENTER]. (p. 38)

Turning OFF the power

- Push [⏻] to turn OFF the power.

Basic operation

- Turn ON the power. (1)
 - Standby indicator is displayed after the Warm-up is completed.
- Adjust the display brilliance and color. (2)
- Push [TX (SAVE)]/[发射(节电)]. (3)
- Push [+] several times until the maximum display range is selected. (4)
- Rotate [GAIN]/[增益] to adjust the gain. (5)
- Push [+] or [-] several times to select a desired display range. (6)
 - The screen range readout shows the range of the screen.
- Rotate [SEA]/[海浪抑制] to set the sea clutter control to minimum. (7)
- Rotate [RAIN]/[雨雪抑制] to set the rain clutter control to minimum. (8)
- Push [MODE]/[工作模式] to select either the Head-up: H-UP, Course-up: C-UP, North-up: N-UP or True Motion: TM screen. (9)
 - C-UP or N-UP can be selected only when bearing data is provided. TM can be selected only when bearing and position data is provided. (See page 53 for details.)

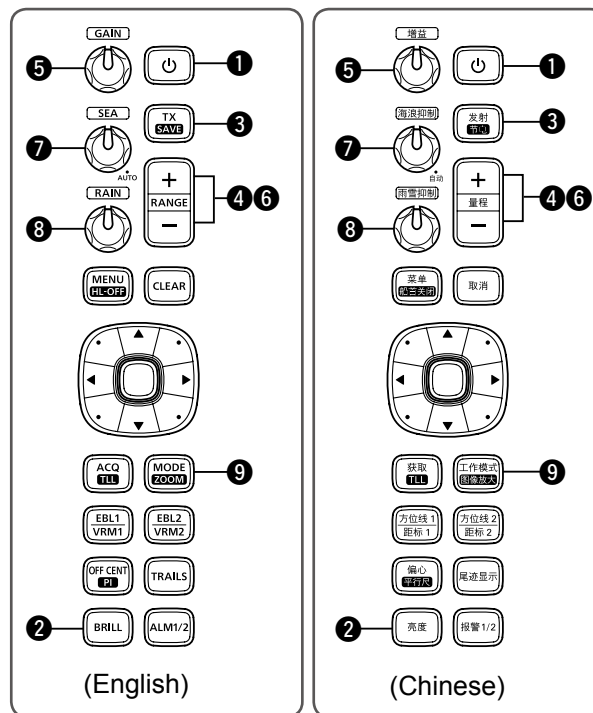

■ Adjusting brilliance and color

◇ Adjusting the display brilliance

The brilliance of the screen can be adjusted. When you require continuous operation, but not constant viewing, a lower setting can increase the life of the LCD.

1. Push [BRILL]/[亮度] to open the Brilliance/Color adjustment box.

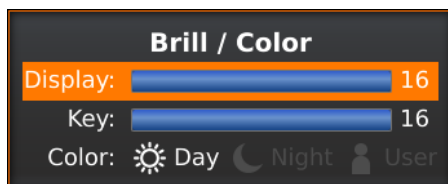

2. Push [◀] or [▶] to adjust the display brilliance.
3. Push [CLEAR]/[取消] to close the box.
 - The adjustment box automatically closes if you do not push any keys for 5 seconds.

- Push [BRILL]/[亮度] to increase or decrease the display brilliance.
- Hold down [BRILL]/[亮度] for 1 second to select maximum brilliance.

NOTE: High intensity will shorten the life of the LCD display.

◇ Adjusting the key backlight

The brilliance of the key backlight can be adjusted for your convenient operation.

1. Push [BRILL]/[亮度] to open the Brilliance/Color adjustment box.

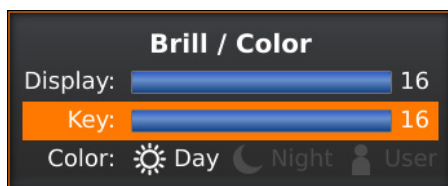

2. Push [▼] to select the “Key” item.
3. Push [◀] or [▶] to adjust the key backlight.
4. Push [CLEAR]/[取消] to close the box.
 - The adjustment box automatically closes if you do not push any keys for 5 seconds.

◇ Selecting the display color

The Day (white background), Night (black background), and User settings are selectable.

1. Push [BRILL]/[亮度] to open the Brilliance/Color adjustment box.

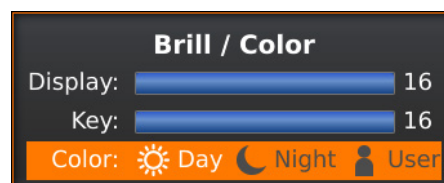

2. Push [▼] twice to select the “Color” item.
3. Push [◀] or [▶] to select a display color.
 - ① You can set the display color to the Day, Night, or User.
4. Push [CLEAR]/[取消] to close the box.
 - The adjustment box automatically closes if you do not push any keys for 5 seconds.

◇ Customizing the Display color

You can customize the foreground and background color of each color setting, in the Color menu. See the “Menu Screen” for details. (p.39)

(MENU > Color)

1. Push [MENU]/[菜单] to display the Menu screen.
2. Push [◀] or [▶] to select the Color menu.
3. Push [▲] or [▼] to select the Color settings.
 - The selected item is highlighted.
4. Push [ENTER]/[确认] to enter the option selection mode.
5. Push [◀] or [▶] to select a display color, then push [ENTER]/[确认].

◇ Brilliance of the fixed range rings

The fixed range rings can be used for rough distance measurements. (p. 17)

The brilliance of the fixed range rings can be adjusted or turned OFF.

(MENU > Color > Ring Brill)

1. Push [MENU]/[菜单] to display the Menu screen.
2. Push [◀] or [▶] to select the Color menu.
3. Push [▲] or [▼] to select the “Ring Brill” item.
 - The selected item is highlighted.
4. Push [ENTER]/[确认] to enter the option selection mode.
5. Push [◀] or [▶] to select a Ring Brilliance 1, 2, 3 or OFF.
6. Push [ENTER]/[确认] to save the setting and exit the option selection mode.
 - ① Push [CLEAR]/[取消] to cancel the setting and exit the mode.

NOTE: Refer to Chapter 3 for details on the fixed range ring settings. (p.17)

■ Adjusting the screen

The followings are typical basic operation examples that may hinder radar reception (sea clutter, precipitation interference and echoes from other radar). See also Basic Radar Theory in Chapter 9 (pp. 47–49)

◇ Adjusting the GAIN

- Rotate the **GAIN** / **增益** control clockwise to increase, or counter clockwise to decrease the gain.
 - ① The increased gain may increase screen noise. Adjust the gain to the point where the screen noise just disappears.

◇ SEA function

The SEA function eliminates echoes from waves at close range. Reduce the receiver gain for close objects within a radius of approximately 8 NM to eliminate sea clutter.

- Rotate the **SEA** / **海浪抑制** control until the echoes from sea waves disappears.
 - The SEA icon (☼) is displayed in the upper left corner of the screen when the SEA function is active.

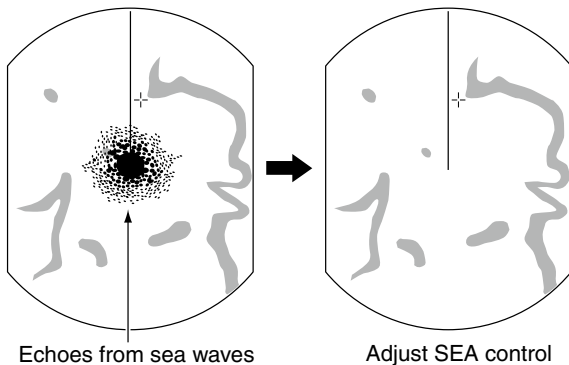

- Rotate the **SEA** / **海浪抑制** control fully clockwise to activate the automatic control.
 - “AUTO” is displayed below the SEA icon (☼) when the automatic control function is active.

NOTE: The **SEA** / **海浪抑制** control reduces the receiver sensitivity of objects within approximately 8 NM. Therefore, when the SEA setting is set to too high, close targets are blanked. Small objects may not be displayed on the screen when strong echoes from rain or islands within 1 NM while the automatic SEA function is activated.

◇ RAIN function

This function eliminates echoes from rain, snow, fog, and so on.

- Rotate the **RAIN** / **雨雪抑制** control fully counterclockwise to deactivate the control function.
 - The RAIN icon (☉) disappears.

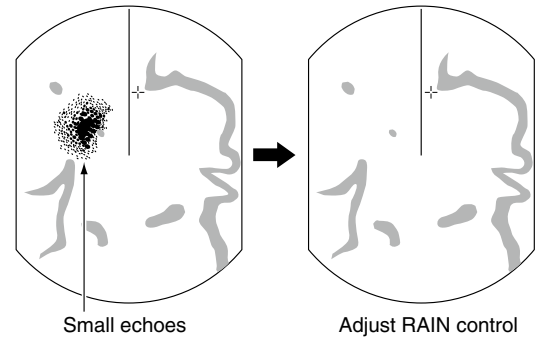

◇ Manual tuning

The receiver tuning can be manually adjusted.

(MENU ▷ Video ▷ **Tune**)

1. Push [MENU]/[菜单] to display the Menu screen.
2. Push [◀] or [▶] to select the Video menu.
3. Push [▲] or [▼] to select the “TUNE” item.
 - The selected item is highlighted.
4. Push [ENTER]/[确认] to enter the option selection mode.
5. Push [◀] or [▶] to select “Manual,” then push [ENTER]/[确认].
 - “TUNE (MAN)” is displayed at the top of the screen.
6. Push [▼] to select the “Manual TUNE” item.
 - The selected item is highlighted.
7. Push [ENTER]/[确认] to enter the option selection mode.
 - If the “TUNE” item is set to “Auto,” you cannot enter the option selection mode.
8. Push [◀] or [▶] to adjust the tuning level. (p. 43)
9. Push [ENTER]/[确认].
10. Push [MENU]/[菜单] to exit the Menu screen.

◇ Heading marker

The heading marker is a line that indicates your vessel’s bow direction. This marker will be displayed on the center of the screen when the Head-up screen: H-UP is selected. You can temporarily hide the heading marker when the target is located under the heading marker. The heading marker is hidden while holding down the [MENU]/[菜单] key.

■ OFF CENTER function

The scanning area can be shifted in direction and can be partially enlarged. This is useful when the Head-up screen is selected, and you want to enlarge the bow direction display, or the center of the screen shifts in the direction of the intersection.

- ① This function is selectable in 24 NM or shorter ranges.
- ② This function is not selectable in the TM screen.

1. Push [OFF CENT]/[偏心] to shift the screen.
2. Push [OFF CENT]/[偏心] again to return to the normal screen.

The OFF center mode setting can be changed in the "OFF Center Mode" item in the System menu.
 • 25%, 50%, 75%, and Cursor are selectable.

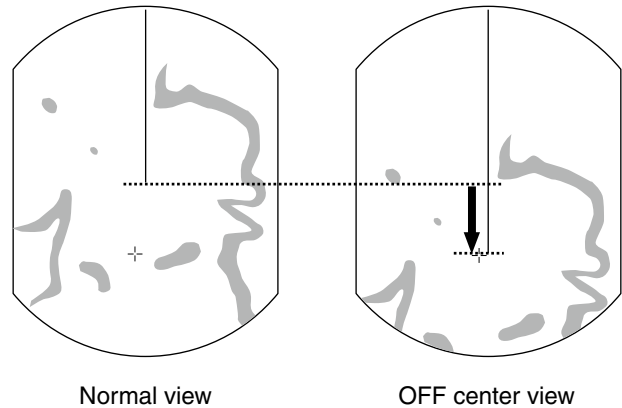

2

■ Zoom function

The Zoom function expands the target to two times normal view.

1. Move the cross-line cursor to a target.
2. Hold down [MODE]/[工作模式] for 1 second to change between the zoomed view and the normal view.
 - The ZOOM icon (⊕) is displayed in the upper right of the screen.

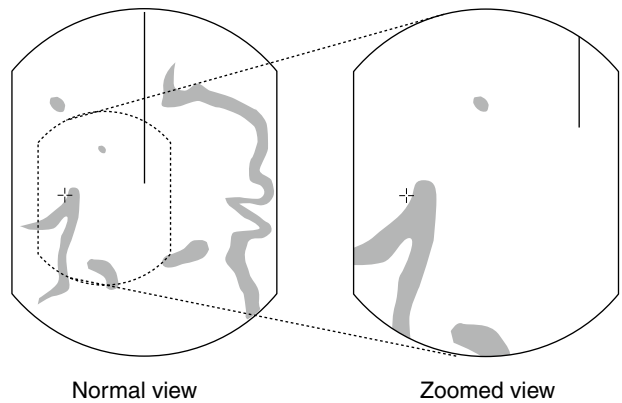

■ Interference Rejection function

Radar interference may be displayed when another vessel's radar is operating on the same frequency band in close proximity. The Interference Rejection (IR) function can eliminate this type of interference.

1. Push [MENU]/[菜单] to display the Menu screen.
2. Push [◀] or [▶] to select the Video menu.
3. Push [▲] or [▼] to select the "IR" item.
4. Push [ENTER]/[确认] to enter the option selection mode.
5. Push [◀] or [▶] to select the IR function 1, 2, or OFF.
6. Push [ENTER]/[确认] to save the setting.
7. Push [MENU]/[菜单] to exit the Menu screen.
 - "IR1" or "IR2" indicator is displayed in the upper right of the screen, when the function is activated.

(MENU ▷ Video ▷ IR)

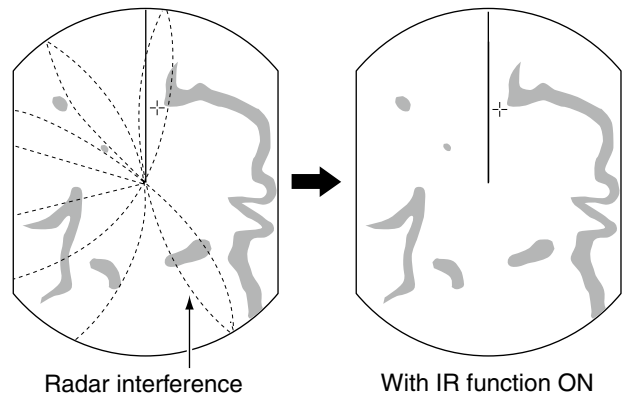

■ Echo Stretch function

The blips can be magnified electronically for easier viewing of small targets.

1. Push [MENU]/[菜单] to display the Menu screen.
2. Push [◀] or [▶] to select the Video menu.
3. Push [▲] or [▼] to select the “Echo Stretch” item.
4. Push [ENTER]/[确认] to enter the option selection mode.
5. Push [◀] or [▶] to select the Echo Stretch ON.
6. Push [ENTER]/[确认] to save the setting.
7. Push [MENU]/[菜单] to exit the Menu screen.
 - “ES” is displayed in the upper right of the screen, when the function is activated.

NOTE: Turn OFF this function during normal operation.

(MENU ▷ Video ▷ **Echo Stretch**)

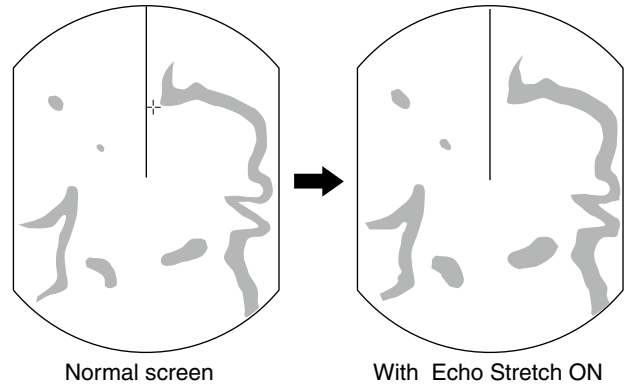

■ Long pulse function

To magnify the blips for easier viewing of small targets, the long pulse and echo stretch functions are usable. When the long pulse is used in the $\frac{3}{4}$ to 3 NM range, this function magnifies target echoes behind the target.

1. Push [MENU]/[菜单].
2. Push [◀] or [▶] to select the Video menu.
3. Push [▲] or [▼] to select the “Pulse Width” item.
4. Push [ENTER]/[确认] to enter the option selection mode.
5. Push [◀] or [▶] to select SP (Short Pulse) or LP (Long Pulse).
 - When “LP” is selected, “Ⓟ” is displayed in the upper left of the screen.
6. Push [ENTER]/[确认] to save the setting.
7. Push [MENU]/[菜单] to exit the Menu screen.

NOTE: Selecting LP (Long Pulse) decreases the target distance resolution. (p. 43)

(MENU ▷ Video ▷ **Pulse Width**)



Trail function

The trail function memorizes echoes continuously or at constant intervals. This is useful for watching other vessels' tracks, approximate relative speed and so on.

Using the Trail function

- Push [TRAILS]/[尾迹显示] to turn ON the Trail function.
 - The trail indicator and the trail interval are displayed in the upper left of the screen.
 - The trail interval counter starts to count up to the trail time.
 - All echoes higher than the specified level at the plotted time are memorized and displayed with a graduated intensity together with the current echoes.
 - Echoes are displayed with minimum intensity when "∞" is selected.
- ① Hold down [TRAILS]/[尾迹显示] for 1 second to reset the trail interval counter and the plotted echoes.
- Push [TRAILS]/[尾迹显示] to cancel the Trail function and clears the plotted echoes.
 - The trail indicator and the trail interval disappear.

Trail indicator Trail interval counter

R Trail 02m 04s

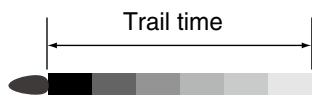
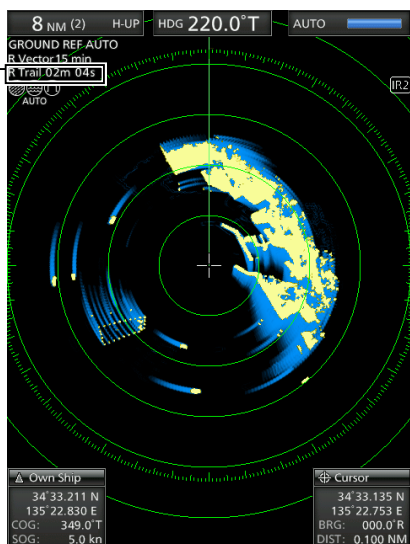

Customizing the trail settings

You can customize the trail settings in the Trail menu of the Menu screen.

- Push [MENU]/[菜单] to display the Menu screen.
- Push [◀] or [▶] to select the Trail menu.
- Push [▲] or [▼] to select an item.
 - ① The selectable settings are described below.
- Push [ENTER]/[确认] to enter the option selection mode.
- Push [◀] or [▶] to select an option.
- Push [ENTER]/[确认] to save the setting.
- Push [MENU]/[菜单] to exit the Menu screen.

(MENU ▷ Trail)

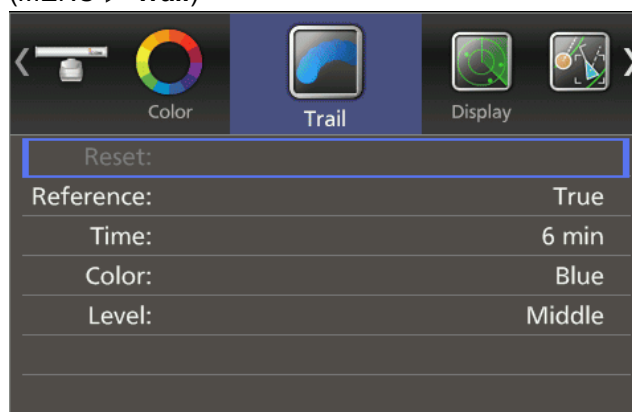

Reference

- True: Regardless of the movement of your vessel, the trail of other vessels displays a real movement over ground. Therefore, a stopped target's trail is not displayed. The True trail requires a heading signal and your own vessel's position information.
- Relative: The trail of other vessels is relative to your vessel. In this mode, other vessels' movement and your vessel's movement are combined, so, Relative trail is valid if you want to look at the relative movement to avoid collisions. However, a stopped target's trail is also displayed. In that case, it is difficult to see in some places such as near islands.

① Regardless of this setting, the display acts as:

- The Relative trail setting when the Head-UP (H-UP) screen is selected.
- The True trail setting when the True motion (TM) screen is selected.

Time

Selects the trail time from 30 seconds, 1 minute, 3 minutes, 6 minutes, 15 minutes, or ∞ (continuous)

Color

Selects the trail time from Blue, Yellow, Green, Red, Orange, and White.

Level

- Low: Leaves a trail between Low and High levels.
- Middle: Leaves a trail between Mid and High levels.
- High: Leaves a trail only at the High level.

■ Power save function

The power save function conserves the vessel's battery power by pausing the transmission. The standby (pausing) times are selectable (rotation number is fixed to 10).

For example, when 1 minute is selected, the scanner rotates 10 revolutions, then stops for 1 minute, and then repeats this sequence while the power save mode is activated.

◇ Setting the scanning standby time

1. Push [MENU]/[菜单]
2. Push [◀] or [▶] to select the System menu.
3. Push [▲] or [▼] to select the "Save Time" item.
4. Push [ENTER]/[确认] to enter the option selection mode.
5. Push [◀] or [▶] to select the standby time.
① 1, 6, 15, and 30 minutes are selectable.
6. Push [ENTER]/[确认] to save the setting.
7. Push [MENU]/[菜单] to exit the Menu screen.

◇ Entering the power saving mode

1. Hold down [TX (SAVE)]/[发射(节电)] for 1 second to enter the power save mode.
 - The "SAVE" indicator is displayed in the upper right of the screen.
2. After the scanning rotations are finished, transmission and rotation are suspended until the selected standby time elapses.
 - "SAVE" and standby time are displayed in the upper right of the screen and the standby time is counted down.
 - After the selected standby time elapses, transmission and rotation restart.
3. Push [TX (SAVE)]/[发射(节电)] to cancel the power save function.
 - The save indicator turns OFF.

NOTE: You can save more power by using the Power save function with the Alarm function. In this case, the LCD display is turned OFF until an object enters the set alarm zone. (p. 21)

(MENU ▷ System ▷ Save Time)

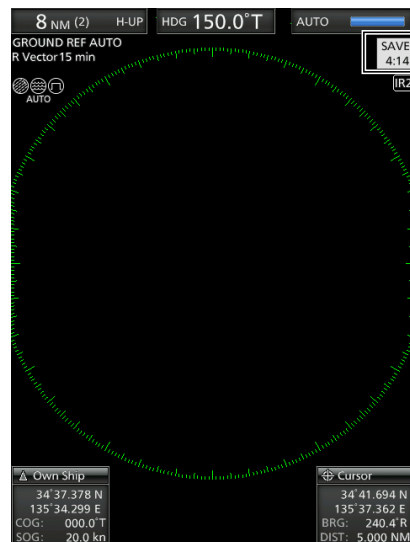
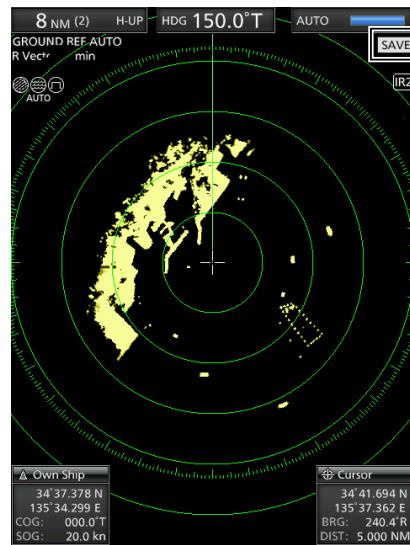

Counts down the standby time

Scan and STBY modes alternate

■ Ship speed indication

When the ship speed data in NMEA 0183 format is applied, the radar can display the ship speed.

1. Push [MENU]/[菜单].
2. Push [◀] or [▶] to select the Initial menu.
3. Push [▲] or [▼] to select the “Speed Unit” item.
4. Push [ENTER]/[确认] to enter the option selection mode.
5. Push [◀] or [▶] to select the speed unit.
① knot (kn) or kilometers/hour (km/h) is selectable.
6. Push [ENTER]/[确认] to save the setting.
7. Push [MENU]/[菜单] to exit the Menu screen.

(MENU ▷ Initial ▷ Speed Unit)

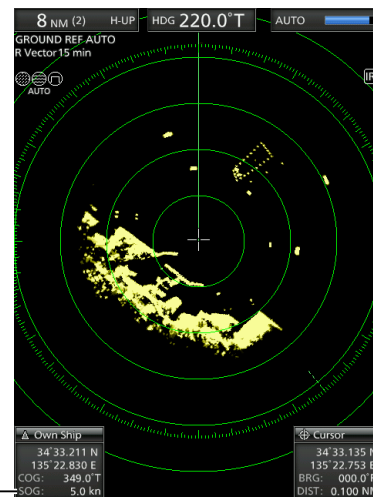

Ship Speed Indicator

■ Waypoint indication

When waypoint data received from navigation equipment in NMEA 0183 format is applied, the radar can display the waypoint.

To display the waypoint marker, bearing data and position data are required. (p. 53)

(MENU ▷ Display ▷ WPT Display)

◇ Displaying the waypoint marker

1. Push [MENU]/[菜单].
2. Push [◀] or [▶] to select the Display menu.
3. Push [▲] or [▼] to select the “WPT Display” item.
4. Push [ENTER]/[确认] to enter the option selection mode.
5. Push [◀] or [▶] to turn the setting ON or OFF.
6. Push [ENTER]/[确认] to save the setting.
7. Push [MENU]/[菜单] to exit the Menu screen.

Waypoint marker

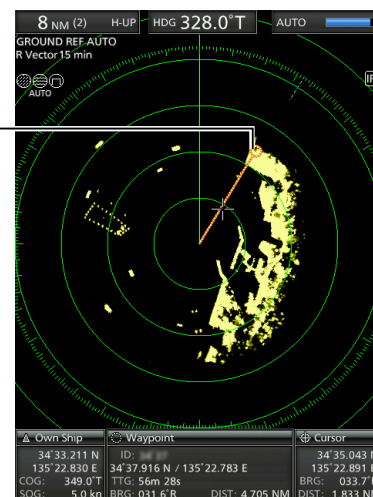

◇ Waypoint information

1. Move the cross-line cursor on the waypoint mark or line.
2. Push [ENTER]/[确认] to display the information.
 - The target identification (ID), position, Time to go (TTG), bearing (BRG), and distance (DIST) are displayed in the information box.



■ Bearing settings

The radar bearing interface accepts NMEA, N+1, AUX, or COG data format and the bearing can use a magnetic or true north type. When a true north type bearing is used, the variation from magnetic north can be adjusted on 0.1° steps.

◇ Setting the bearing input

1. Push [MENU]/[菜单].
2. Push [◀] or [▶] to select the Initial menu.
3. Push [▲] or [▼] to select the “Bearing Input” item.
4. Push [ENTER]/[确认] to enter the option selection mode.
5. Push [◀] or [▶] to select the bearing data source.
 - ① NMEA, N+1, AUX, GPS, or GPS-L is selectable.
 - ① GPS and GPS-L uses the COG (Course Over the Ground) data as the bearing. However, if the vessel's speed is less than 3 knots, direction accuracy falls. Moreover, the position accuracy or the current actual course may vary, therefore the radar may display incorrect direction.
6. Push [ENTER]/[确认] to save the setting.
7. Push [MENU]/[菜单] to exit the Menu screen.

◇ Setting the bearing type

1. Push [MENU]/[菜单].
2. Push [◀] or [▶] to select the System menu.
3. Push [▲] or [▼] to select the “Bearing Mode” item.
4. Push [ENTER]/[确认] to enter the option selection mode.
5. Push [◀] or [▶] to select the Bearing mode.
 - ① True and Magnetic north type are selectable.
 - ① All displayed bearing readouts show the selected bearing type.
6. Push [ENTER]/[确认] to save the setting.
7. Push [MENU]/[菜单] to exit the Menu screen.

(MENU ▷ System ▷ Bearing Mode)

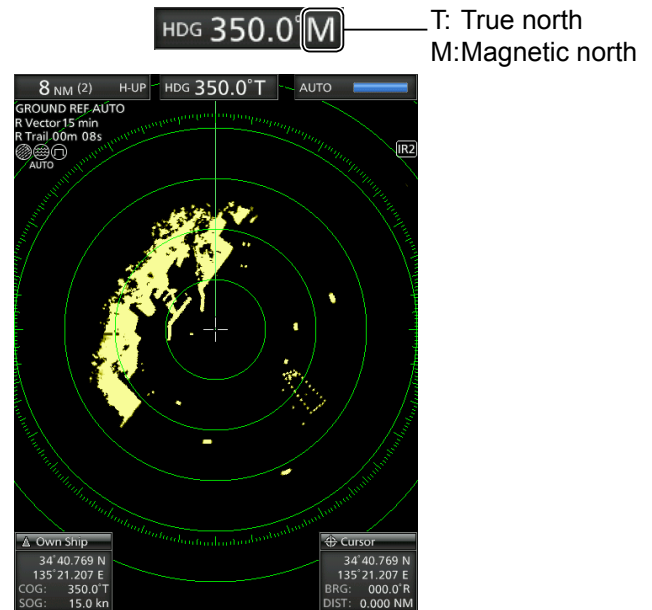

◇ Setting the magnetic variation

1. Push [MENU]/[菜单].
2. Push [◀] or [▶] to select the System menu.
3. Push [▲] or [▼] to select the “Variation” item.
4. Push [ENTER]/[确认] to enter the option selection mode.
5. Push [◀] or [▶] to select the bearing variation.
 - ① “Auto”* and “Manual” are selectable.
6. Push [ENTER]/[确认] to save the setting.
7. When the “Manual” option is selected in step 4, push [▼] to select the “Manual Variation,” then push [ENTER]/[确认].
8. Push [▲] or [▼] to set the bearing variation.
9. Push [ENTER]/[确认] to save the setting.
10. Push [MENU]/[菜单] to exit the Menu screen.

NOTE:

- NMEA data is required for the Auto variation. **NEVER** select “Auto” without NMEA data or incorrect variation data may be entered.
- Until an effective variation is received, use 0° for difference between true North and magnetic North. After an effective variation is received, use the last data for the difference. The MR-1010RII memorize the data until you turn OFF the power.

(MENU ▷ System ▷ Variation)

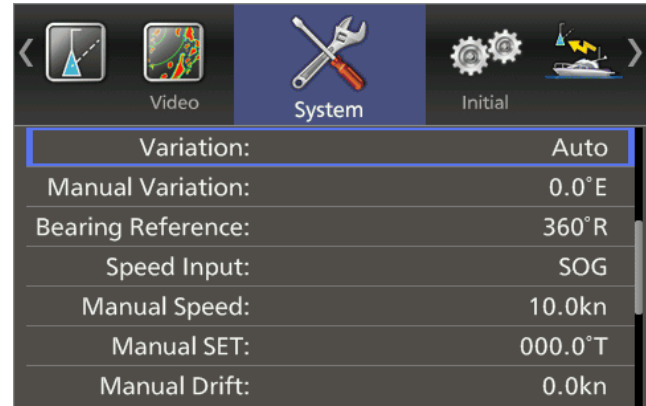

Distance measurement

Various ways to measure the distance are provided with this radar.

① You can select a distance unit from nautical miles (NM), or kilometers (km) in the Initial menu (p. 45).

TYPE	DESCRIPTION
Fixed range ring (RING)	Displays fixed rings. Suitable for rough estimations from your own vessel to any target. Selectable from two types of range rings.
Parallel index lines (PI)	Displays six parallel index lines. Suitable for rough estimations from your own vessel to any target.
Variable range marker 1 (VRM1)	Displays a variable range marker and activated by [▲] or [▼] for the range marker selector. Suitable for accurate measurements from your own vessel to a target.
Variable range marker 2 (VRM2)	Normally functions the same as VRM1. When the VRM1 and EBL1 selects a target, the center of VRM2 appears at the intersection point. Suitable for accurate measurements from target to target.

◇ Using the fixed rings

(MENU ▷ Initial ▷ Range Ring)

1. Push [MENU]/[菜单].
2. Push [◀] or [▶] to select the Initial menu.
3. Push [▲] or [▼] Select the Range Ring item.
4. Push [ENTER]/[确认] to enter the option selection mode.
5. Push [◀] or [▶] to select Ring 1 or Ring 2.
6. Push [ENTER]/[确认] to save the setting.
7. Push [MENU]/[菜单] to exit the Menu screen.

• Fixed rings in each screen range

Range (NM)	Ring range (NM)		Number of rings		Range (km)	Ring range (km)		Number of rings	
	Ring1	Ring2	Ring1	Ring2		Ring1	Ring2	Ring1	Ring2
1/8	0.0625		2		1/4	0.125		2	
1/4	0.125		2		1/2	0.125	0.25	4	2
1/2	0.125		4		3/4	0.25		3	
3/4	0.25		3		1	0.25		4	
1	0.25		4		1.5	0.5	0.25	3	6
1.5	0.5	0.25	3	6	2	0.5		4	
2	0.5		4		3	1	0.5	3	6
3	1	0.5	3	6	4	1		4	
4	1		4		6	2	1	3	6
6	2	1	3	6	8	2		4	
8	2		4		12	3		4	
12	3	2	4	6	16	4		4	
16	4		4		24	6		4	
24	6	4	4	6	32	8		4	
32	8		4		36	12		3	
36	12		3		48	12		4	

NOTE: When the screen is shifted, the number of rings may differ.

◇ Using the Parallel index lines

1. Hold down [PI]/[平行尺] for 1 second.
 - The crossed lines are displayed.
2. Push [▲] or [▼] to increase or decrease the range of lines, and [◀] or [▶] to rotate the lines.
 - The direction of the parallel index lines and the line interval are displayed on the lower right of the screen.
3. Push [ENTER]/[确认] to set lines.
4. Hold down [PI]/[平行尺] for 1 second to clear the parallel index lines.

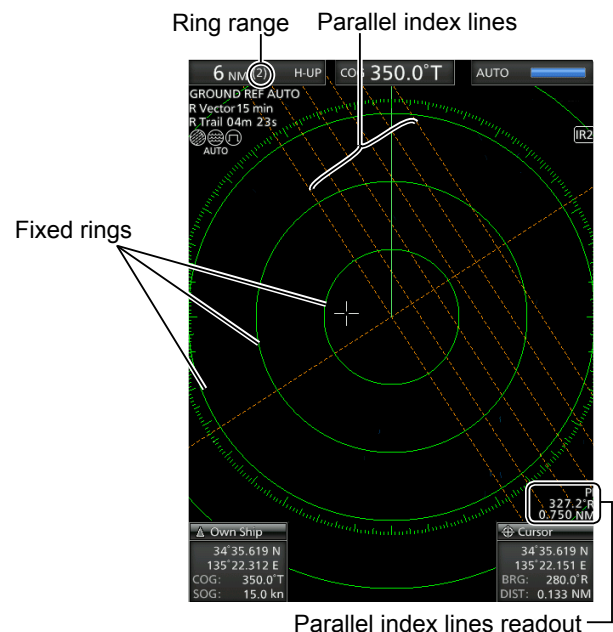

◇ Using the variable range marker

1. Push [EBL1 (VRM1)]/[方位线1(距标1)] to display the VRM1 and EBL1, then push [▲] or [▼] to set the marker.
 - The range between the vessel and the target is indicated in the EBL/VRM1 readout.
2. Push [ENTER]/[确认] to set the EBL/VRM1 setting.
3. Push [EBL2 (VRM2)]/[方位线2(距标2)] to display the VRM2 and EBL2, then push [▲] or [▼] to set the marker.
 - The range between the vessel and the target is indicated in the EBL/VRM2 readout.
 - When VRM1 and EBL1 are displayed, the center of VRM2 is displayed at the intersection point of VRM1 and EBL1.

4. Push [ENTER]/[确认] to set the EBL/VRM2 setting.
5. Push [EBL1 (VRM1)]/[方位线1(距标1)] to clear the EBL1 and VRM1.
6. Push [EBL2 (VRM2)]/[方位线2(距标2)] to clear the EBL2 and VRM2.

■ Bearing and Distance measurement

This radar has two Electronic Bearing Lines (EBL) to indicate the target direction from your vessel or a target.

◇ Using both the EBL and VRM

1. Move the cross-line cursor onto the target.
2. Push [EBL1 (VRM1)]/[方位线1(距标1)] to display the EBL1 and VRM1.
 - Push [◀] or [▶] to rotate the Electronic Bearing Line.
 - Push [▲] or [▼] to increase or decrease the Variable Range Marker's ring size.
 - The EBL/VRM1 readout indicates the target bearing and distance.
 - The EBL readouts indicate the target bearing.
 - The indication may differ, depending on the setting in the "Bearing Reference" item of the System menu (p. 12).
 - 0 to 360°R: Relative direction, when "360°R" is selected in the "Bearing Reference" item.
 - P/S 0 to 180°: Bow direction, when "PT/SB" is selected in the "Bearing Reference" item.
 - 0 to 360°T*: True or magnetic bearing, when selecting "True" in the "Bearing Reference" item.

*Bearing data is required. (p. 53)
3. Push [ENTER]/[确认] to set the EBL/VRM1 setting.
4. Move the cross-line cursor onto the target.
5. Hold down [EBL1 (VRM1)]/[方位线1(距标1)] for 1 second to move the EBL1 and VRM1 to the cursor.
 - ① Hold down [EBL1 (VRM1)]/[方位线1(距标1)] for 1 second again to move the EBL1 and VRM1 to the original place.
6. Push [EBL1 (VRM1)]/[方位线1(距标1)] to clear the EBL1 and VRM1.
 - ① Cursor remains on the display.

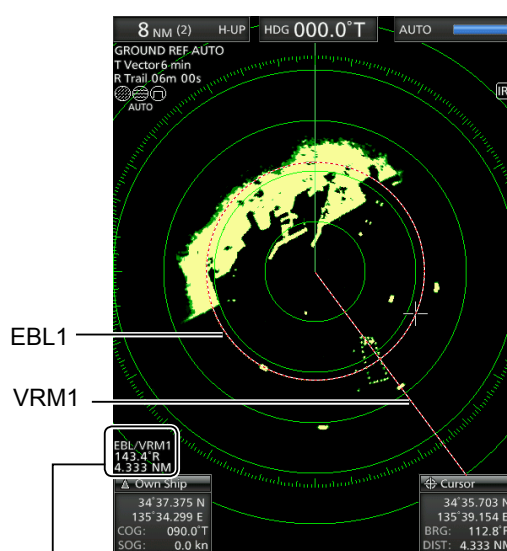

EBL/VRM1 readout

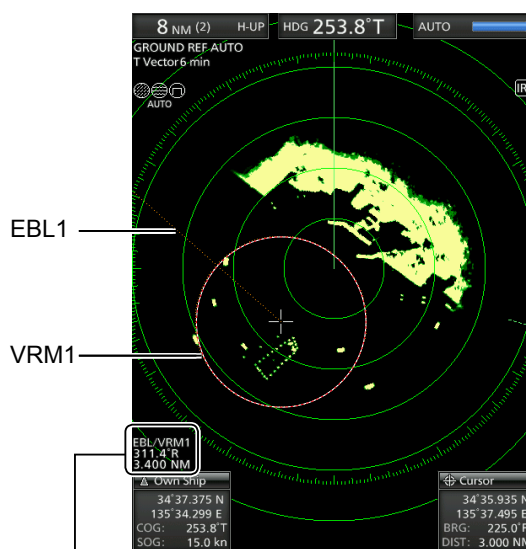

EBL1/VRM1 readout

Advanced measurements

Using both Electronic Bearing Lines (EBL) and both Variable Range Markers (VRM), the following advanced measurements can be made.

Measuring the distance and direction between two targets

1. Move the cursor onto the target.
2. Push [EBL1 (VRM1)]/[方位线1(距标1)] to display the EBL1 and VRM1.
 - ① Push [◀] or [▶] to rotate the Electronic Bearing Line.
 - ① Push [▲] or [▼] to increase or decrease the Variable Range Marker ring size.
3. Push [ENTER]/[确认] to set the VRM/EBL1 setting.
4. Push [EBL2 (VRM2)]/[方位线2(距标2)] to display the EBL2 and VRM2.
 - The intersection of the EBL1 and VRM1 becomes the center of the EBL2 and VRM2.
5. Push [▲], [▼], [◀], or [▶] to move the cursor onto the other target.
 - ① Push [◀] or [▶] to rotate the Electronic Bearing Line.
 - ① Push [▲] or [▼] to increase or decrease the Variable Range Marker ring size.
6. The VRM2 readout displays the distance between the two targets. The EBL2 readout displays the direction from one target to the other.

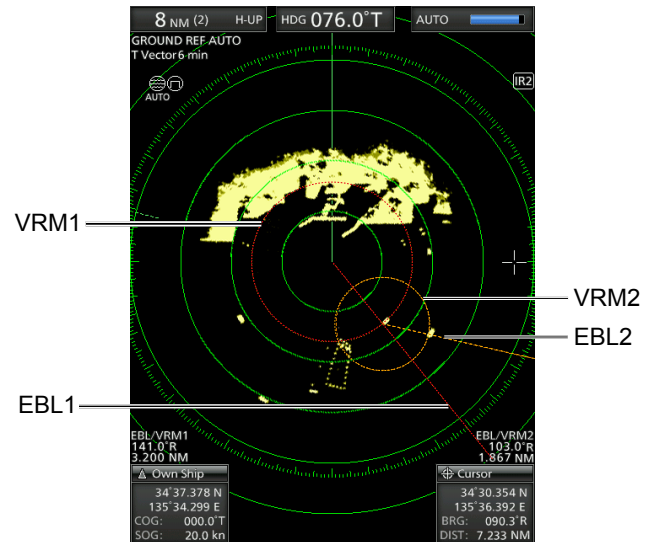

Measuring the relative speed and course of a target

1. Push [TRAILS]/[尾迹显示] to turn ON the Trail function, and then the trail extends until it reaches to the preset trail time. (p. 12)
 - The trail icon and trail interval are displayed in the upper left of the screen.
2. Push [EBL1 (VRM1)]/[方位线1(距标1)] to display the EBL1 and VRM1, and then set the VRM1 and EBL1 to a previously plotted target.
 - ① Push [◀] or [▶] to rotate the Electronic Bearing Line.
 - ① Push [▲] or [▼] to increase or decrease the Variable Range Marker ring size.
3. Push [ENTER]/[确认] to set the VRM/EBL1 setting.
4. Push [EBL2 (VRM2)]/[方位线2(距标2)] to display the EBL2 and VRM2, and then set the VRM2 and EBL2 to the current plotted position of the same target.
 - The intersection of the EBL1 and VRM1 becomes the center of the EBL2 and VRM2.
5. The VRM2 is a measure of target movement that can be converted into relative target speed.
 - ① For example, when a 6 minute trail time is selected, multiplying the distance by ten gives the relative average speed of the target.
 - ① If your vessel is stationary during the plotting time, the converted speed and direction become absolute.
 - ① The converted speed unit is knots, kilometers or miles, depending on the Distance Unit in the Initial menu.
6. The EBL2 displays the course direction of the target.

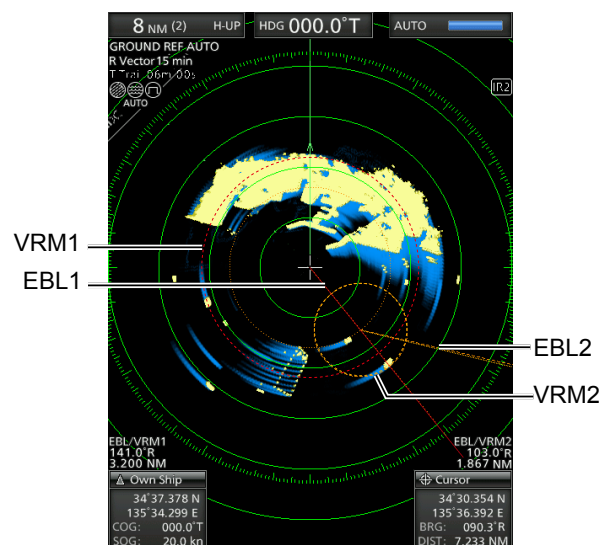

◇ Measuring the distance and course from a waypoint

1. Display a waypoint as described on page 14.
2. Push [EBL1 (VRM1)]/[方位线1(距标1)] to display the EBL1 and VRM1, and then set the VRM1 and EBL1 to the waypoint.
 - Push [◀] or [▶] to rotate the Electronic Bearing Line.
 - ① Push [▲] or [▼] to increase or decrease the Variable Range Marker ring size.
3. Push [ENTER]/[确认] to set the VRM/EBL1 setting.
4. Push [EBL2 (VRM2)]/[方位线2(距标2)] to display the EBL2 and VRM2, and then set the VRM2 and EBL2 to a target point, for example a next waypoint.
 - The intersection of the EBL1 and VRM1 becomes the center of the EBL2 and VRM2.
5. The VRM2 displays the distance to the target from the first waypoint.
 - The distance unit can be selected as nautical miles (NM) or kilometers (km) in the Initial menu.
6. The EBL2 readout displays the direction to the target from the first waypoint.

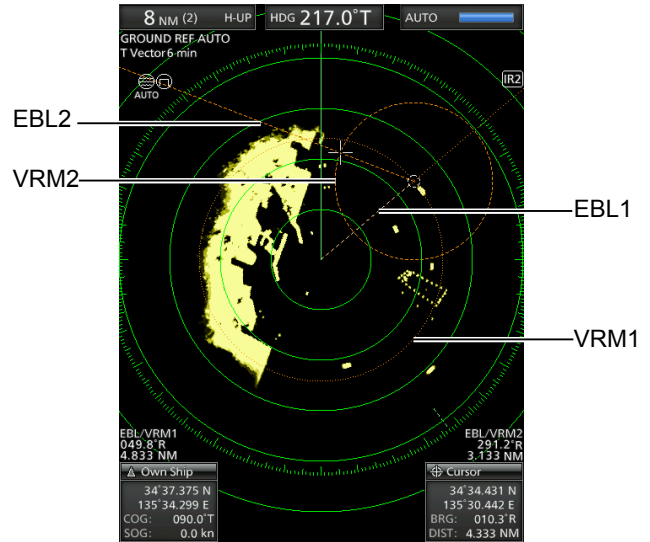

The unit has an alarm function to protect your vessel from collisions. If other vessels, islands, or other obstructions come into the preset alarm zone, the function alerts you with an alarm. You can set the range and bearing for up to two alarm zones. While the alarm function is activated, the power save function turns off the LCD screen until an alarm is given, to conserve the power.

■ Setting the Alarm zone

◇ Setting and using the alarm function

1. Push [+] or [-] to select a range.
2. Move the cross-line cursor to the starting point of the alarm zone.
3. Push [ALM1/2]/[报警1/2] several times to turn ON the Alarm 1 and/or Alarm 2.
 - The Alarm icon (📡) on the upper right of the screen and the preset alarm zone(s) is displayed. (Fig. 1)
4. Hold down [ALM1/2]/[报警1/2] for 1 second to enter the alarm zone setting.
 - The starting zone is displayed on the screen. (Fig. 1)
5. Push [◀] or [▶] to adjust an angle and push [▲] or [▼] to set the distance of the alarm zone.
 - The selected alarm zone is displayed.
6. Push [ALM1/2]/[报警1/2] to set the alarm zone and activate the alarm function.
 - The Alarm icon is displayed.
 - The selected alarm zone remains.
7. If a target comes into or goes out of the alarm zone, an alarm sounds.
 - ① Push [CLEAR]/[取消] to stop the alarm.
 - ① Push [ALM1/2]/[报警1/2] to cancel the alarm signal and function.
8. To deactivate the alarm function, push [ALM1/2]/[报警1/2] several times.
 - The Alarm icon and alarm zone disappears.
9. To activate the alarm function again with the same zone, push [ALM1/2]/[报警1/2].
 - “📡” and the preset alarm zone is displayed. (Fig. 2)

NOTE: If “📡✕” is displayed, the alarm function is invalid because the range is too small. In that case, push [+] one or more times until the alarm icon returns to “📡”.

◇ Entering the power save mode

The Alarm function is also available when the MR-1010RII is in the power save mode.

- Hold down [TX (SAVE)]/[发射(节电)] for 1 second while the Alarm function is ON.
 - The power save mode is activated and the display turns OFF.
- ① When a target comes into the alarm zone, an alarm sounds, the display turns ON, and the power save mode is cancelled.

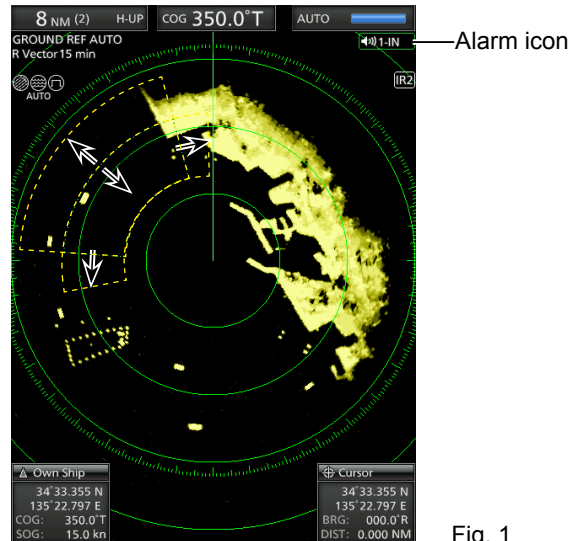

Fig. 1

Use cursor pad to adjust the alarm zone, then push [ALM1/2]/[报警1/2] to set it.

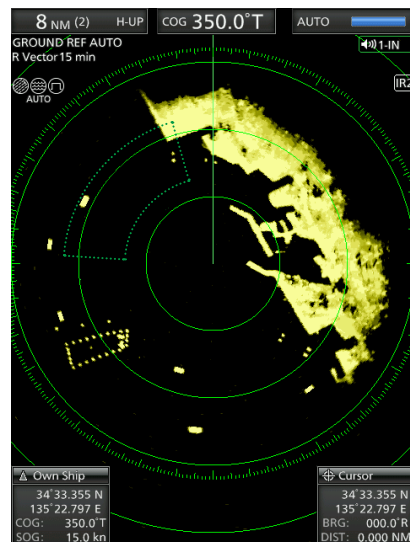

Fig. 2

■ Setting Zone alarm type

A zone alarm sounds when the target comes into the zone, or when the target goes out of the zone. (p. 13)

1. Push [MENU]/[菜单], and then push [◀] or [▶] to select the System menu.
2. Push [▲] or [▼] to select the “Zone Alarm1” or “Zone Alarm2” item.
3. Push [ENTER]/[确认] to enter the option selection mode.
4. Push [◀] or [▶] to select IN or OUT.
 - IN: Alarm sounds when the target comes into the zone.
 - OUT: Alarm sounds when the target goes out of the zone.
5. Push [ENTER]/[确认] to save the setting.
6. Push [MENU]/[菜单] to exit the Menu screen.

(MENU ▷ System ▷ **Zone Alarm1**)

(MENU ▷ System ▷ **Zone Alarm2**)

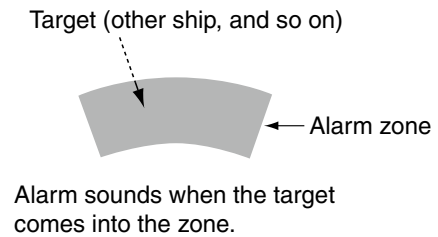

The simplified Automatic Radar Plotting Aids (ARPA) function is designed to help prevent a collision with other vessels or landmasses.

The radar automatically acquires and plots other vessels and landmasses that are in the set watch area. It automatically calculates the closest point of approach (CPA), and the time to closest point of approach (TCPA) limit of your vessel and the targets, and sounds an alarm if there is a danger of colliding with them.

ARPA Features

- Only targets in the 0.25 to 16 NM range that are displayed with a high luminosity (strong return signal) can be selected as ARPA targets.
- Up to 10 targets can be acquired and plotted on the screen, including up to 5 automatically acquired targets (when the Auto Acquire function (p.25) is turned ON in the Menu screen).
- Plot positions are identified by an approved symbol mark (p. 24) and associated plot number.
- The target and vector line will move across the screen at the rate and direction defined by the calculated true or relative course and speed.
- The vector line is displayed on the target.

■ ARPA operation

◇ Operation

Select a target on the screen that you want to track.

1. Move the cross-line cursor onto a target.
2. Push [ACQ]/[获取] to set the target for tracking.
 - A dotted circle symbol is displayed on the cursor.
 - After 1 minute progressing time has passed, the circle changes to a solid circle with a dotted vector line, the number of the target is displayed beside the icon, and tracking operation starts.
 - When the target disappears, a red cross blinks on the target, and then the mark disappears after 1 minute.
 - When a target advances within the CPA and TCPA limits, the mark changes its color to red, blinks, and sounds an alarm. To cancel the alarm, push [CLEAR]/[取消].
3. To display a target information, move the cross-line cursor onto the target, and then push [ENTER]/[确认].
 - The corners of a square is displayed on the selected target.
 - The target identification number, position, course (CRS), speed (SPD), CPA, TCPA, bearing (BRG), and distance (DIST) are displayed.

 ARPA(Relative) No.2	
34°38.448 N / 135°22.664 E	
R CRS: 172.7°T	R SPD: 15.9 kn
CPA: 0.594 NM	TCPA: 07m 19s
BRG: 022.6°R	DIST: 2.030 NM

4. To release the target, move the cursor onto the target, then hold down [CLEAR]/[取消] for 1 second.



■ Descriptions of ARPA targets

◇ The status icons

The followings are the status icons for APRA targets.

Status	Description
○	Focused target is displayed with the orange colored circle
◻○	Selected target is displayed with corners of the square
◻○	Selected, started to acquire automatically or manually.
○	Acquired target Approximately 1 minute after the acquirement is started, the dotted circle icon changes to a circle, and the vector of the vessel is displayed.
○ ₅	Target with a number Displayed when the No. Display setting in the ARPA menu in the Menu screen is set to "Select" or "all".
☀	CPA/TCPA alarm mark. The target is close to within a minimum range and time. • Alarm sounds and red colored mark blinks until acquiring the target. Push [ACQ]/[获取] to acquire the target, or push [CLEAR]/[取消] to cancel the alarm.
⊗	Indicates the tracking of a target is lost. • Alarm sounds, red cross blinks, and "ARPA target lost" is displayed. Push any key to cancel the alarm.

◇ Course and speed vector

The vector indicates the target's predicted, true or relative course and speed.

- The vector time may change, depending on the setting in the "Vector Time" item of the Target menu (p. 41).
- The tip of the vector shows the target's predicted position after the time selected in the "Vector Time" item of the Target menu (p.41).

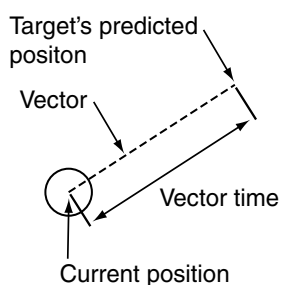

◇ Plots (ARPA)

The plot displays the target's past positions as 5 dots, during each specified tracking interval.

- The target track interval may change, depending on the setting in the "Track Interval" item of the Target menu. (p. 41)

Plots	Status
	Target is going straight
	Target is turning right
	Target is reducing speed (dots are closer together behind the target)
	Target is increasing speed (dots are farther apart behind the target)

■ ARPA settings

You can customize the ARPA settings in the ARPA menu of the Menu screen.

1. Push [MENU]/[菜单].
2. Push [◀] or [▶] to select the ARPA menu.
3. Push [▲] or [▼] to select the item.
4. Push [ENTER]/[确认] to enter the option selection mode.
5. Push [◀] or [▶] to select an option.
6. Push [ENTER]/[确认] to save the setting.
7. Push [MENU]/[菜单] to exit the Menu screen.

(MENU ▷ ARPA)

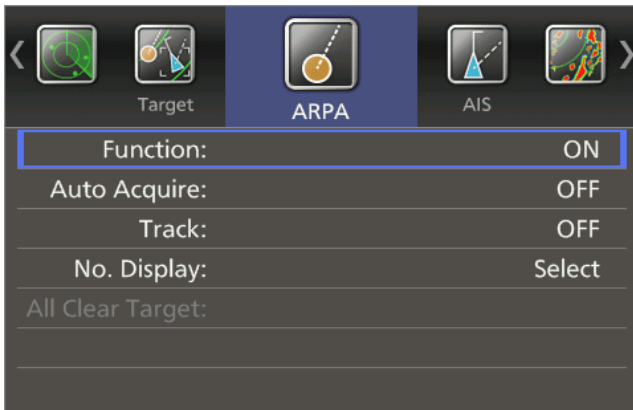

Function (Default: ON)

- OFF: Turns OFF the ARPA (Automatic Radar Plotting Aid) function.
- ON: Turns ON the ARPA function.

Auto Acquire (Default: OFF)

Sets whether the MR-1010R11 automatically acquires targets or not.

- OFF: Does not automatically acquire a target.
- ON: Automatically acquires up to 5 targets.

Track (Default: OFF)

The plot displays the target's past positions as 5 dots, during each specified tracking interval.

You can specify the track interval in the "Track Interval" item of the Target menu.

- OFF: Turns OFF the Track display function.
- ON: Turns ON the Track display function.

No. Display (Default: Select)

Select the target identification number type that is displayed at the right side of the mark.

- OFF: Does not display any mark number.
- Select: Displays only the selected mark number.
- All: Displays all mark numbers.

All Clear Targets

Releases all of the ARPA targets at the same time.

1. Push [ENTER]/[确认].
2. Push [◀] to select "OK".
3. Push [ENTER]/[确认] again to release all ARPA targets.
 - The "All Clear Target" item is grayed out.

■ Related settings

You can change the target settings for ARPA operation. The settings of the Target menu are commonly used for the ARPA and AIS operations. See page 41 for the Target menu details.

The Target menu items and their default settings are as follows.

- Vector Mode: True
- Vector Time: 6 min
- Track Interval: 1 min
- CPA* Limit: 1.0 NM
- TCPA* Limit: 1 min
- CPA/TCPA Alarm: ON

*CPA/TCPA: Closest Point of Approach and Time to Closest Point of Approach limits are set to give a warning when a target or targets enter those limits around your own vessel.

■ About AIS

The Automatic Identification System (AIS) is primarily used for collision-risk management and navigation safety. It automatically transmits and receives vessel information, such as the vessel name, MMSI code, vessel type, position data, speed, course, destination and more. Information is exchanged among the vessels and/or base stations on the VHF maritime mobile band. The information helps to identify other nearby vessels or stations by displaying the received data on a plotter or a radar screen.

There are 7 types of AIS stations, vessels, base stations, Search and Rescue (SAR), Aids to Navigation (AtoN), Search and Rescue Transmitter (AIS-SART), Man OverBoard (MOB), and Emergency Position Indicating Radio Beacon-AIS (EPIRB-AIS).

Also, there are 2 classes of AIS units, which are installed on vessels, Class A and Class B.

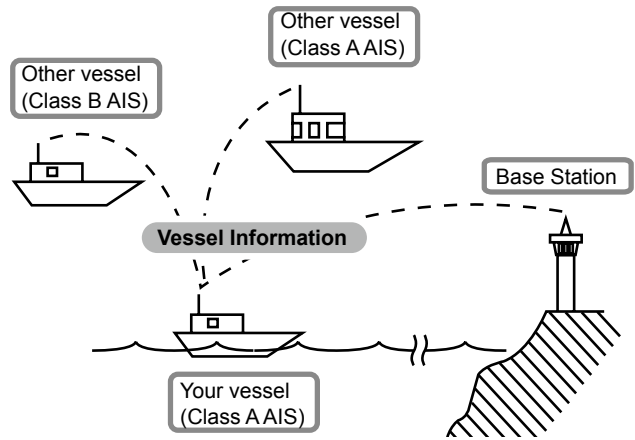

■ AIS operation

◇ Displaying AIS information

Select a target whose information you want to display on the screen.

- Turn ON the AIS display and set its settings. (pp. 29–31)
- 1. Move the cross-line cursor onto a target.
- 2. Push [ENTER]/[确认] to select the target.
 - The corners of a square are displayed on the selected target and the target information is displayed in the AIS information box.
 - AIS Class, MMSI number, Vessel name, Course (CRS), Speed (SPD), CPA, TCPA, bearing (BRG), and distance (DIST) are displayed.

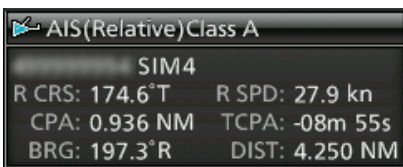

① Information

- If several targets are overlapped on the screen, push [ENTER]/[确认] to sequentially select a target.
- When the target disappears, red crosses blink on the target, and then the mark disappears after 6 minutes and 40 seconds.

Displaying the AIS Details

1. Move the cross-line cursor onto a target.
2. Hold down [ENTER]/[确认] for 1 second.
 - The AIS details is displayed in the message box.
 - Push [CLEAR]/[取消] to close the message box.

Activating the sleeping target manually

1. Select a sleeping target, then holding down [ENTER]/[确认] for 1 second to display the AIS details.
2. Push [ENTER]/[确认] to change the selected target to activated.
3. Push [CLEAR]/[取消] to close the AIS details message box.

Changing the activated target to sleeping

- Move the cross-line cursor to an activated target, then hold down [CLEAR]/[取消] for 1 second to change the selected target to sleeping.

◇ Warning message by AIS receiver

When a target advances within the CPA and TCPA limits, mark changes its color to red and blinks. A warning message is displayed, and an alarm sounds. Push [CLEAR]/[取消] to cancel the alarm.

■ Description of the AIS display

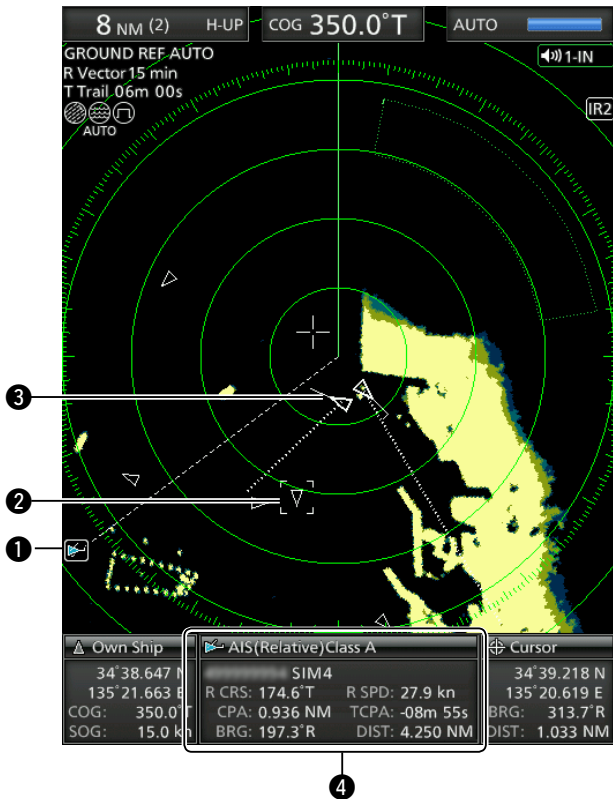

◇ AIS target icons

The AIS targets are displayed with an icon described below, depending on the type of the target.

Icon	Description
	Vessel (p. 28) The tip of the target triangle automatically points in the direction it's heading.
	Vessel (p. 28) The vessel that the CPA and TCPA could not be calculated.
	Base Station
	Search and Rescue (SAR)
	Search and Rescue (SAR) craft
	Aids to Navigation (AtoN)
	Virtual Aids to Navigation (Virtual AtoN)
	Search and Rescue Transponder (SART), MAN OVERBOARD (MOB), or Emergency Position Indicate Radio Beacon (EPIRB)

① AIS indicator:

Displayed when a valid VDM sentence is received from the [NMEA1] (AIS) port.
The indicator disappears if the AIS signal is not received for 6 minutes.

② Selected AIS target:

Four corners of a square are displayed when a target is selected. The details of the selected AIS target is displayed in the AIS information box (④).

③ AIS target:

The icons in the table to the top left are displayed as AIS targets.

④ AIS information box

Displays the selected AIS information.
AIS Class, MMSI number, Vessel name, Course (CRS), Speed (SPD), CPA, TCPA, bearing (BRG), and distance (DIST) are displayed.

- ① Your vessel icon is displayed in the center of the standby screen when a valid VDM sentence is input from the [NMEA1] (AIS) port.
- ① The AIS target icons are displayed when "AIS" is selected in the "STBY Mode" item of the System menu (p. 31).

If more than the specified AIS signals are received, "△ AIS Data is Full" is displayed.
The number of AIS signals are specified in the "Number of AIS" item of the AIS menu.

◇ **Status of the vessel icon**

There are 5 kinds of target vessel status.

Sleeping target:

➤ The AIS signal has been updated (received), but the distance from your vessel is far, or you set it as 'sleeping.' The target is displayed as just a triangle without a heading or vector line.

Activated target:

➤ The target is displayed with the heading line, SOG (Speed Over Ground), COG (Course Over Ground) vector and ROT (Rate of Turn).

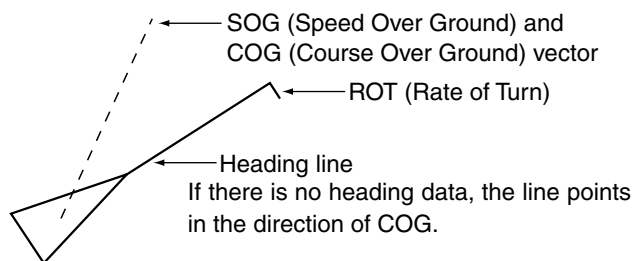

Dangerous target:

➤ Even if the target's status is sleeping or activated, when it enters your CPA and TCPA limit settings, the target is displayed with a thick line and changes its color to red.

Selected target:

➤ The target's information is displayed in the data area.

Lost target*:

➤ When the AIS signal has not been updated (received) for a specific period of time, the target triangle is marked with a red cross. If the AIS signal has still not been updated (received) for 6 minutes and 40 seconds, the target icon disappears.

*A vessel is regarded as a "Lost target" after a specified period of time has passed since the vessel last transmitted data. (p.29)

◇ **Plots (AIS)**

The plot displays the activated target, SAR, SART, MOB, or EPIRB's past positions as 5 dots, during each specified tracking interval.

• The target track may change, depending on the setting in the "Track Interval" item of the Target menu. (p. 31)

Plots	Status
	Target is going straight
	Target is turning right
	Target is reducing speed
	Target is increasing speed

■ AIS settings

You can customize the AIS function in the Menu screen .

1. Push [MENU]/[菜单], and then push [◀] or [▶] to select the AIS menu.
2. Push [▲] or [▼] to select the item.
3. Push [ENTER]/[确认] to enter the option selection mode.
4. Push [▲], [▼], [◀], or [▶] to select an option.
5. Push [ENTER]/[确认] to save the setting.
6. Push [MENU]/[菜单] to exit the Menu screen.

◇ AIS menu

(MENU ▷ AIS)



Display (Default: ON)

Turns the AIS Display function ON or OFF when the MR-1010R11 is in Transmitting (TX) mode.

- OFF: Turn OFF the AIS display function.
- ON: Turn ON the AIS display function.

Track (Default: OFF)

The plot displays the AIS target's past positions as 5 dots, during each specified tracking interval.

You can specify the track interval in the "Track Interval" item of the Target menu.

- OFF: Turn OFF the Track display function.
- ON: Turn ON the Track display function.

Name Display (Default: OFF)

Selects the AIS target display type.

- OFF: Does not display any name or number of the target.
- Select: Displays the vessel name of the selected target.
- Active: Displays all active target numbers.

Auto Activate (Default: ON)

The Auto Activate function automatically turns the sleeping AIS target into an activated target when the AIS target is at the specified distance or angle. You can specify the distance or angle in the next two items.

- OFF: Turn OFF the Auto Activate function.
- ON: Turn ON the Auto Activate function.

Auto Activate - Distance (Default: 1.0NM)

Sets the distance from your vessel to between 0.1 and 10.0 NM, to automatically turn the sleeping AIS target into an activated target.

Auto Activate - Angle (Default: ±180°)

Sets the angle from your vessel between 5 to 180° to automatically turn the sleeping AIS target into an activated target.

New Target Warning (Default: OFF)

Sets whether the MR-1010R11 gives a warning when the Auto Activate function automatically turns the sleeping AIS target into an activated target, or not.

- OFF: Does not give a warning when the Auto Activate function activates the target.
- ON: Gives a warning when the Auto Activate function activates the target.

Number of AIS (Default: 100)

Selects the maximum number of AIS targets that can be displayed on the screen to between 10 and 100 in 1 target steps.

Slow Warn (Default: ON)

The AIS unit calculated COG (Course Over Ground) data of a vessel that is at anchor or drifting is unreliable, and therefore the CPA (Closest Point of Approach) and TCPA (Time to CPA) data may not be correctly calculated. If a vessel is anchored in your alarm zone, the unreliable data can cause the collision alarm to sound many times, even if there is no real danger. To prevent this, when the anchored vessel's SOG (Speed Over Ground) is less than this set value, the Slow Warn function assumes that vessel's COG is fixed towards your vessel and an alarm will sound.

- OFF: Turn OFF the Slow Warn function.
- ON: Turn ON the Slow Warn function.

Slow Warn Speed (Default: 0.1kn)

Selects the vessel's speed to between 0.1 and 5.0 kn, in 0.1 kn steps.

Erase Lost Target (Default: ON)

Clears all of the Lost targets at the same time.
When there are no lost targets, this setting grays out.

1. Push [ENTER]/[确认].
2. Push [◀] to select <OK>.
3. Push [ENTER]/[确认] again to clear all of the Lost targets on the screen.

About “Lost Target”: A vessel is regarded as a “Lost target” after a specified period of time has passed since the vessel last transmitted data, as described below.

The “Lost target” icon disappears from the screen 6 minutes and 40 seconds after the vessel was regarded as a “Lost target.”

The criteria to become a Lost target**• Class A/B**

Vessel type		Nominal reporting interval Class A	Lost target maximum interval Class A	Nominal reporting interval Class B *1		Lost target maximum interval Class B *1		
				CS *2	SO *3	CS *2	SO *3	
1	Class A	Vessel is at anchor or moored and not moving faster than 3 knots	3 min.	18 min.	—	—	—	—
	Class B	Vessel is not moving faster than 2 knots	—	—	3 min.	3 min.	18 min.	18 min.
2	Vessel is at anchor or moored and moving faster than 3 knot		10 sec.	60 sec.	N/A*4		N/A*4	
3	Class A	Vessel is moving between 0 and 14 knots	10 sec.	60 sec.	—	—	—	—
	Class B	Vessel is moving between 2 and 14 knots	—	—	30 sec.	30 sec.	180 sec.	180 sec.
4	Class A	Vessel is moving between 0 and 14 knots while changing course	3 1/3 sec.	60 sec.	—	—	—	—
	Class B	Vessel is moving between 2 and 14 knots while changing course	—	—	30 sec.	30 sec.	180 sec.	180 sec.
5	Vessel is moving between 14 and 23 knots		6 sec.	36 sec.	30 sec.	15 sec.	180 sec.	90 sec.
6	Vessel is moving between 14 and 23 knots while changing course		2 sec.	36 sec.	30 sec.	15 sec.	180 sec.	90 sec.
7	Vessel is moving faster than 23 knots		2 sec.	30 sec.	30 sec.	5 sec.	180 sec.	30 sec.
8	Vessel is moving faster than 23 knots while changing course		2 sec.	30 sec.	30 sec.	5 sec.	180 sec.	30 sec.

*1 AIS Class B does not provide information about the navigation status, anchored or moored.

*2 CS: Carrier-sense, *3 SO: Self organized, *4 N/A: Not available

• Others

Category	Nominal reporting interval	Lost target maximum interval
SAR	10 sec.	60 sec.
Base station	10 sec.	60 sec.
AtoN	3 min.	18 min.

■ AIS Settings (Continued)

Safety Message (Default: ON)

Sets whether the MR-1010RII displays the message when a safety message is received.

- OFF: Turns OFF the Safety Message function.
- ON: Turns ON the Safety Message function.

Favorite AIS (Default: ON)

Sets whether the MR-1010RII notifies that the Specified MMSI target gets into the specified range from your vessel, or not.

- OFF: Turns OFF the Favorite AIS function.
- ON: Turns ON the Favorite AIS function.

Favorite AIS Range (Default: 8.0NM)

Sets the Favorite AIS display range to between 0.1 and 36.0 NM, in 0.1 NM steps.

Favorite AIS Target1 / 2 / 3

Enters MMSI numbers of up to 3 vessels as your favorite AIS targets.

■ Related settings

◇ Target menu

You can change the target settings for the AIS operation. The settings of the Target menu are commonly used for the ARPA and AIS operations. See page 7 for the Target menu details.

These are the Target menu items and their default settings.

- Vector Mode: True
- Vector Time: 6 min
- Track Interval: 1 min
- CPA* Limit: 1.0 NM
- TCPA* Limit: 1 min
- CPA/TCPA Alarm: ON

*CPA/TCPA: Closest Point of Approach and Time to Closest Point of Approach limits are set to give a warning when a target or targets enter those limits around your own ship.

◇ System menu

You can display the AIS targets in the Standby mode. Set the STBY Mode setting to "AIS" in the System menu to display the AIS targets when the MR-1010RII is in the Standby mode.

■ Receiving DSC Information

The radar can plot received DSC information from other vessels on the screen. An external DSC data is required to use this function.

The plottable DSC formats are:

- Distress
- Distress ACK
- Distress Relay (All Ships)
- Distress Relay ACK (All Ships)
- Distress Relay (Geographic)
- Distress Relay (Individual)
- Distress Relay ACK (Individual)
- Position ACK
- Position Report

◇ Receiving DSC

When DSC information is received:

- The emergency alarm sounds.
- An icon that displays the type of DSC call is plotted on the screen.
- The readout pops up that includes the “Received DSC,” format of the DSC, sender’s MMSI, and the nature of distress are displayed.



- Hold down [ENTER]/[确认] for 1 second to display the detailed information, or push [CLEAR]/[取消] to close the message box.
 - Also the alarm stops.
 - ① Push [CLEAR]/[取消] to close the DSC details message.

◇ DSC setting

You can select the DSC display setting in the Menu screen.

1. Push [MENU]/[菜单] to display the Menu screen.
2. Push [◀] or [▶] to select the Display menu.
3. Push [▲] or [▼] to select the DSC Display item.
4. Push [ENTER]/[确认] to enter the option selection mode.
5. Push [◀] or [▶] to select an option.
6. Push [ENTER]/[确认] to save the setting.
7. Push [MENU]/[菜单] to exit the Menu screen.

(MENU ▷ Display ▷ DSC Display)

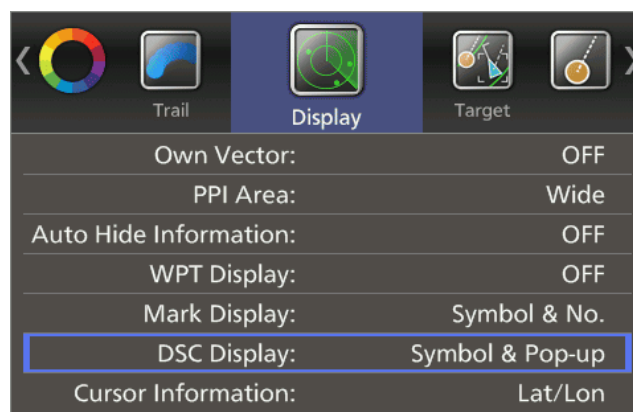

DSC Display (Default: Symbol & Pop-up)

Sets whether the MR-1010RII displays the DSC information or not.

- OFF: DSC information is not displayed.
- Symbol: A Symbol is displayed.
 - ① When “Symbol” is selected, the alarm does not sound even if a DSC is received.
- Pop-up: DSC information pops up.
- Symbol & Pop-up: A symbol is displayed, and DSC information pops up.

■ TLL function

The TLL (Target Latitude and Longitude) function marks the target on the display or outputs its data to an external unit.

◇ TLL setting

1. Push [MENU]/[菜单] to display the Menu screen.
2. Push [◀] or [▶] to select the System menu.
3. Push [▲] or [▼] to select the "TLL Mode" item.
4. Push [ENTER]/[确认] to enter the option selection mode.
5. Push [◀] or [▶] to select an option.
 - ① "Output," "Symbol," and "Output & Symbol" are selectable.
6. Push [ENTER]/[确认] to save the setting.
7. Push [MENU]/[菜单] to exit the Menu screen.

(MENU ▷ System ▷ TLL Mode)

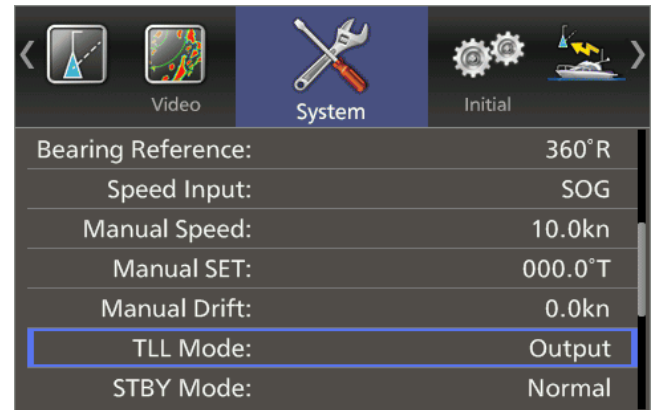

◇ Operation

Select a target on the screen that you want to mark.

1. Move the cross-line cursor onto a place.
2. Hold down [ACQ•TLL]/[获取•TLL] for 1 second to mark the point.
 - ① When the "Output" or "Output & Symbol" is selected in the "TLL Mode" in the System menu, outputs the position information from the NMEA output terminal.
 - ① When the "Symbol" or "Output & Symbol" is selected in the "TLL Mode" of the System menu, displays the target mark.
3. Repeat steps 1 and 2 until you complete marking places.
 - ① Hold down [CLEAR]/[取消] for 1 second to delete the selected mark.

TLL symbol

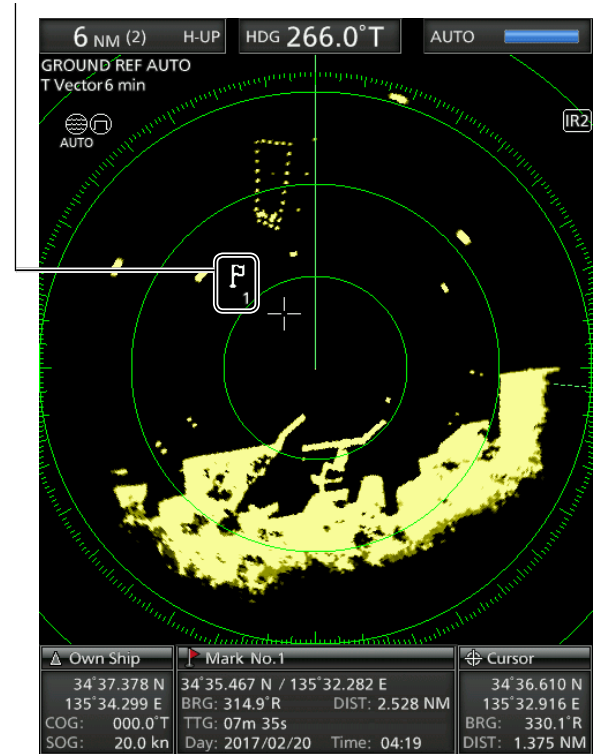

◇ Information box

1. Move the cross-line cursor onto a mark.
2. Push [ENTER]/[确认] to display the information.
 - The target identification number, position, bearing (BRG), distance (DIST), Time to go (TTG), and day/time (Day/Time) are displayed.



- ① To close the information box, move the cursor to anywhere there is no mark, then push [ENTER]/[确认].

■ Select the language

You can select a language of the menus, messages, indicators and so on. The selectable language differs, depending on the version of your display unit.

1. Push [MENU]/[菜单] to display the Menu screen.
2. Push [◀] or [▶] to select the Initial menu.
3. Push [▲] or [▼] to select the “Language” item.
4. Push [ENTER]/[确认] to enter the option selection mode.
5. Push [◀] or [▶] to select the display language, “English” or another.
 - ① The selectable languages are differ, depending on the Display unit's version.
6. Push [ENTER]/[确认] to save the setting.
7. Push [MENU]/[菜单] to exit the Menu screen.

(MENU ▷ Initial ▷ Language)



■ Simulation mode

The MR-1010RII has a simulation mode capability.

1. While holding down [BRILL]/[亮度], push [⏻] to turn ON the power.
 - After the opening screen, the standby screen is displayed. While the MR-1010RII is in the simulation mode, “Simulation Mode” is displayed in the upper of the screen.
2. Push [TX (SAVE)]/[发射(节电)] to operate in the simulation mode.
3. To return to normal operating mode, turn OFF the power, then turn it ON again.

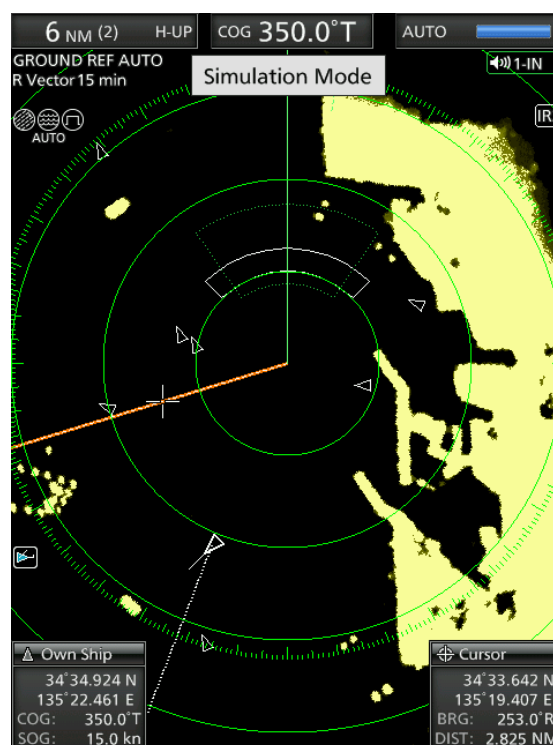

■ Antenna rotation speed

The antenna rotation speed can be selected between Normal (36 rpm) and Slow (24 rpm) in the 1/2, 1/4 or 1/8 range.

1. Push [MENU]/[菜单] to display the Menu screen.
2. Push [◀] or [▶] to select the Initial menu.
3. Push [▲] or [▼] to select the “Antenna Rotation Speed” item.
4. Push [ENTER]/[确认] to enter the option selection mode.
5. Push [◀] or [▶] to select “Normal” or “Slow” antenna rotation speed.
6. Push [ENTER]/[确认] to save the setting.
7. Push [MENU]/[菜单] to exit the Menu screen.

(MENU ▷ Initial ▷ **Antenna Rotation Speed**)

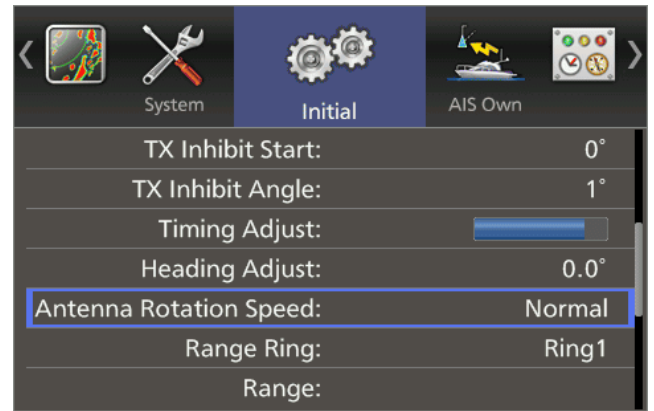

■ Timing adjustment

The system cable length affects the sweep timing. The cable length must be adjusted properly, otherwise a straight target is shown as a curved echo.

1. Position your vessel near a straight target such as breakwater, wharf, and so on.
2. Push [–] several times to select the 1/8 or 1/4 NM range.
3. Push [TX (SAVE)]/[发射(节电)] to display the target on the screen.
4. Push [MENU]/[菜单] to display the Menu screen.
5. Push [◀] or [▶] to select the Initial menu.
6. Push [▲] or [▼] to select the “Timing Adjust” item.
7. Push [ENTER]/[确认] to enter the option selection mode.
8. Push [◀] or [▶] to adjust the echo until it becomes straight. (See below.)
9. Push [ENTER]/[确认] to save the setting.
10. Push [MENU]/[菜单] to exit the Menu screen.

(MENU ▷ Initial ▷ **Timing Adjust**)

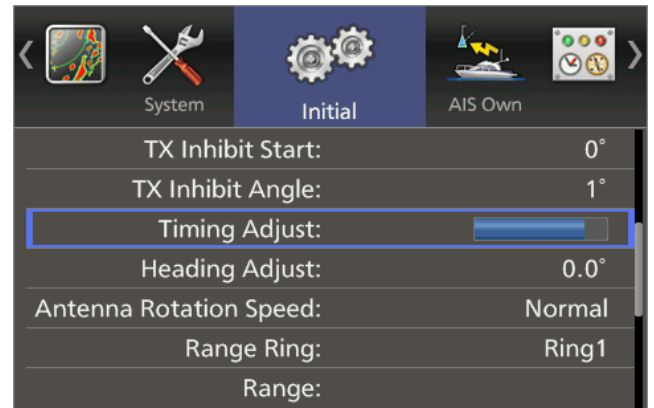

Proper adjustment

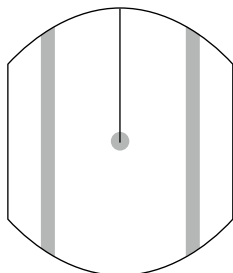

Improper, pulling inward

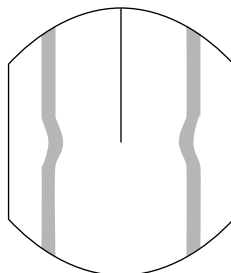

Improper, pushing outward

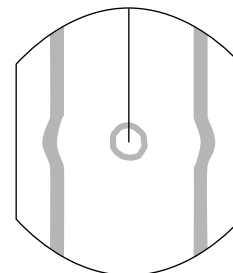

■ Heading adjustment

If the heading marker line differs from the exact bow direction, adjust the heading marker line manually. This may be helpful when the scanner has not been mounted correctly in the line with the bow.

1. Line up the bow of the boat with a fixed target.
2. Push [TX (SAVE)]/[发射(节电)] to display the target on the screen.
3. Push [MENU]/[菜单] to display the Menu screen.
4. Push [◀] or [▶] to select the Initial menu.
5. Push [▲] or [▼] to select the “Heading Adjust” item.
6. Push [ENTER]/[确认] to enter the option selection mode.
7. Push [▲] or [▼] to adjust the heading until the target on the screen meets the heading marker. (The difference can be readout on the menu screen.)
8. Push [ENTER]/[确认] to save the setting.
9. Push [MENU]/[菜单] to exit the Menu screen.

(MENU ▷ Initial ▷ **Heading Adjust**)

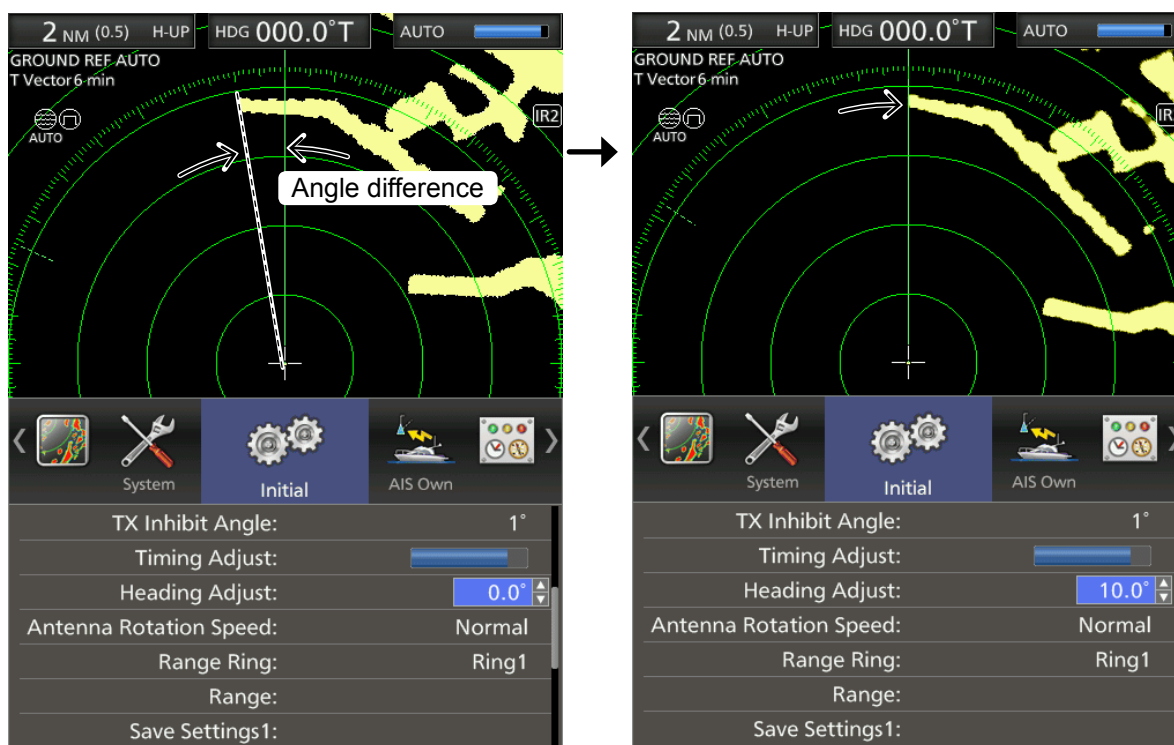
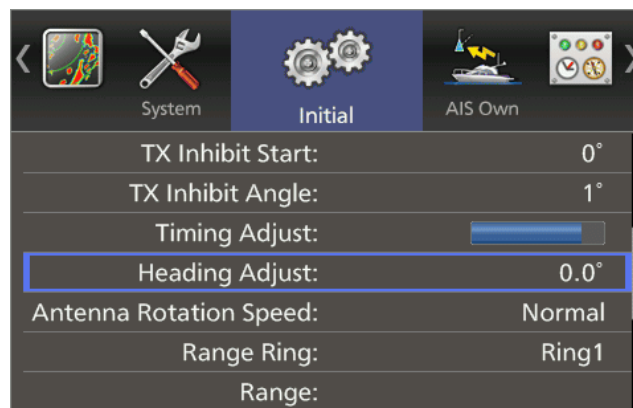

Push [▲] or [▼] to adjust the heading.

Range selection

You can customize the selectable range. If you set a range to OFF, the range is skipped when you change the range by pushing [+] or [-].

1. Push [MENU]/[菜单] to display the Menu screen.
2. Push [◀] or [▶] to select the Initial menu.
3. Push [▲] or [▼] to select the “Range” item.
4. Push [ENTER]/[确认] to enter the option selection mode.
5. Push [▲] or [▼] to select the range that you want to change the setting.
6. Push [◀] to set the range to OFF, or push [▶] to set it ON.
7. Repeat steps 5 and 6 until you complete the range selection.
 - ① The selectable ranges are 1/8, 1/4, 1/2, 3/4, 1, 1.5, 2, 3, 4, 6, 8, 12, 16, 24, 32, 36 (NM).
8. Push [ENTER]/[确认] to save the setting.
 - ① Do not push [CLEAR]/[取消] that exits the range selection screen without saving the settings.
9. Push [MENU]/[菜单] to exit the Menu screen.

(MENU ▷ Initial ▷ Range)

• Option selection mode



Save and load settings

The MR-1010RII can save three different settings for different operators or different situations, and immediately change from one to another.

The save or load settings are the settings of the items in the Color, Trail, Display, Target, ATA, AIS, Video, and System menus.

① “Save settings” and “Load settings” are selectable only in the Standby mode.

◇ Save settings

1. Push [MENU]/[菜单] to display the Menu screen.
2. Push [◀] or [▶] to select the Initial menu.
3. Push [▲] or [▼] to select either the “Save Settings1,” “Save Settings2,” or “Save Settings3” item.
4. Push [ENTER]/[确认].
5. Push [◀] to select <OK>, then push [ENTER]/[确认] to save the settings.
6. Push [MENU]/[菜单] to exit the Menu screen.

◇ Load settings

You can load the saved settings.

1. Push [MENU]/[菜单] to display the Menu screen.
2. Push [◀] or [▶] to select the Initial menu.
3. Push [▲] or [▼] to select either the “Load Settings1,” “Load Settings2,” or “Load Settings3” item that you want to load.
 - The load item is grayed out when the settings have not been saved.
4. Push [ENTER]/[确认] to enter the option selection mode.
5. Push [◀] to select <OK>, then push [ENTER]/[确认].
 - The selected settings are loaded.
6. Push [MENU]/[菜单] to exit the Menu screen.

(MENU ▷ Initial ▷ Save Settings1, 2, or 3)

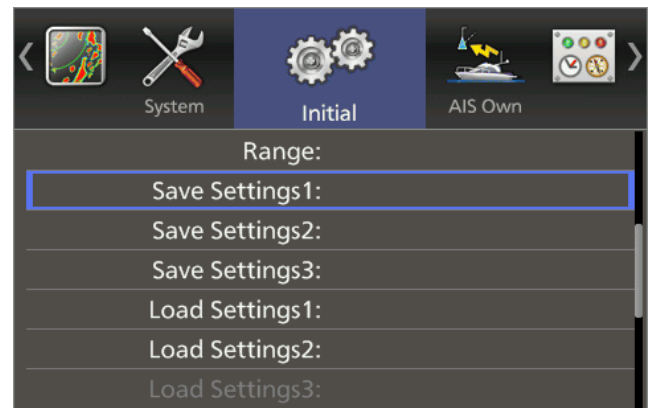

(MENU ▷ Initial ▷ Load Settings1, 2, or 3)

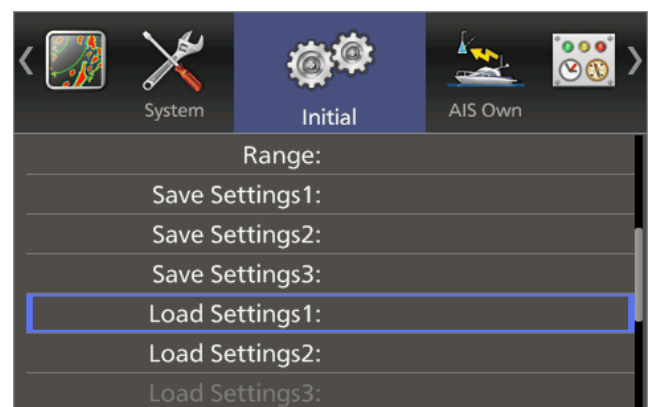

■ Resetting

The MR-1010RII has two reset modes. One is "Setting Reset" and the other is "Factory Reset." "Setting Reset" resets all of the settings other than the settings in the Initial menu. "Factory Reset" resets all of the settings including the settings in the Initial menu.

① Resetting is made on the Standby mode.

◇ Setting Reset

1. Push [MENU]/[菜单] to display the Menu screen.
2. Push [◀] or [▶] to select the Initial menu.
3. Push [▲] or [▼] to select the "Setting Reset" item.
 - ① The Reset items are grayed out if the radar is in the TX mode. Push [TX (SAVE)]/[发射(节电)] in this case.
4. Push [ENTER]/[确认] to enter the option selection mode.
5. Push [◀] or [▶] to select <OK>.
6. Push [ENTER]/[确认] to reset the settings.
7. Push [MENU]/[菜单] to exit the Menu screen.

◇ Factory Reset

1. Push [MENU]/[菜单] to display the Menu screen.
2. Push [◀] or [▶] to select the Initial menu.
3. Push [▲] or [▼] to select the "Factory Reset" item.
 - ① The Reset items are grayed out if the radar is in the TX mode. Push [TX (SAVE)]/[发射(节电)] in this case.
4. Push [ENTER]/[确认] to enter the option selection mode.
5. Push [◀] or [▶] to select <OK>.
6. Push [ENTER]/[确认] to reset the settings.
 - After resetting, the display unit automatically restarts and displays the Initial set up screen.
7. Push [▲] or [▼] to select language.
 - ① Selectable languages differ, depending on the display unit's version.
8. Push [ENTER]/[确认] to display the Standby screen.

(MENU ▷ Initial ▷ Setting Reset)

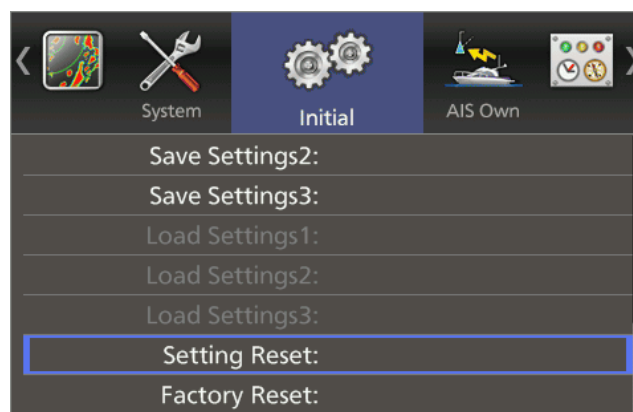

(MENU ▷ Initial ▷ Factory Reset)

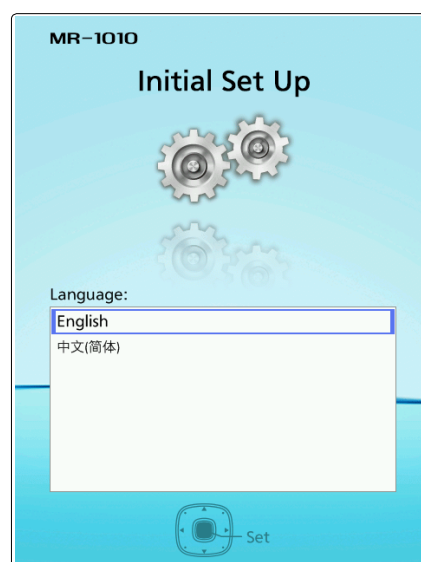
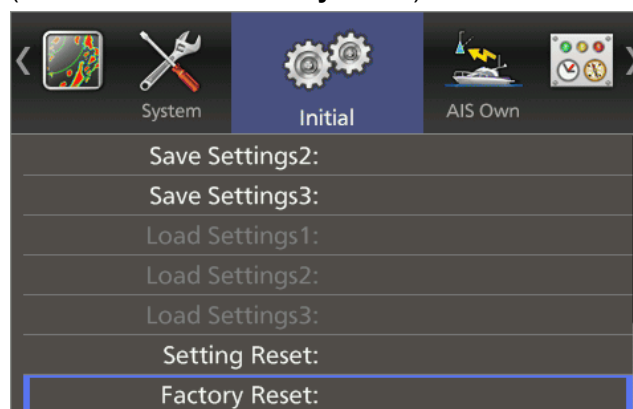

■ Operation in the Menu screen

1. Push [MENU]/[菜单] to display the Menu screen.

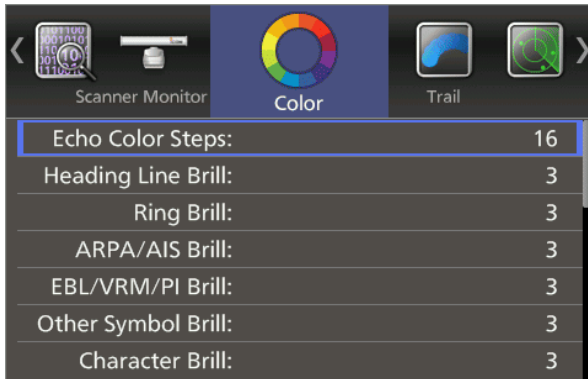

2. Push [◀] or [▶] to select the menu.
 - ① You can select the “Color,” “Trail,” “Display,” “Target,” “ARPA,” “AIS,” “Video,” “System,” “Initial,” “AIS Own,” “Status,” “Port Monitor,” and “Scanner Monitor” menus.
3. Push [▲] or [▼] to select the item.
 - The selected item is highlighted.
4. Push [ENTER]/[确认] to enter the option selection mode.
5. Push [◀], [▶], [▲], or [▼] to select an option.
6. Push [ENTER]/[确认] to save the setting and exit the option selection mode.
 - ① Push [CLEAR]/[取消] to cancel the setting and exit the mode.
7. Push [MENU]/[菜单] to exit the Menu screen.

■ Color menu

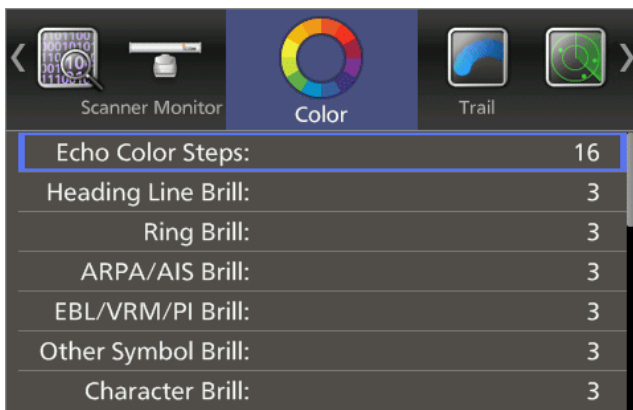

Echo Color Steps (Default: 16)

Sets the gradation steps of an echo display, to 8 or 16.

Heading Line Brill (Default: 3)

Sets the Heading line brilliance to 1 (dark), 2 (normal), or 3 (bright).

Ring Brill* (Default: 3)

- OFF: The fixed range rings are not displayed, and the scale is displayed dark.
- 1 to 3: The range rings and the scale are displayed in 1 (dark), 2 (normal) or 3 (bright).

ARPA/AIS Brill* (Default: 3)

Sets the Brilliance of the ARPA and AIS symbols to 1 (dark), 2 (normal), or 3 (bright).

- ARPA: Automatic Radar Plotting Aid
- AIS: Automatic Identification System

EBL/VRM/PI Brill* (Default: 3)

Sets the Brilliance of the EBL (Electronic Bearing Lines), VRM (Variable Range Markers), and PI (Parallel Index Lines) to 1 (dark), 2 (normal), or 3 (bright).

Other Symbol Brill* (Default: 3)

Sets the Brilliance of other than above symbols to between 1 (dark), 2 (normal), or 3 (bright). This setting is not applied to an echo.

Character Brill* (Default: 3)

Sets the Brilliance of the character out of the scale to between 1 (dark), 2 (normal), or 3 (bright).

* When the background color is set to White, 1 is bright and 3 is dark.

Day Color Setting (Default: Green-White)

Sets the display color for day time to Green-White, Yellow-White, Red-White, or Multi-White.

XX-White: The background color is fixed to white.

Night Color Setting (Default: Multi-Black)

Sets the display color for night time to Green-Black, Yellow-Black, Red-Black, or Multi-Black.

XX-Black: The background color is fixed to black.

User Color Setting (Default: Yellow-Black)

Sets the display color for custom settings to Green, Yellow, Red or Multi.

You can also set the background color to Black, Dark Blue, or White.

Trail menu

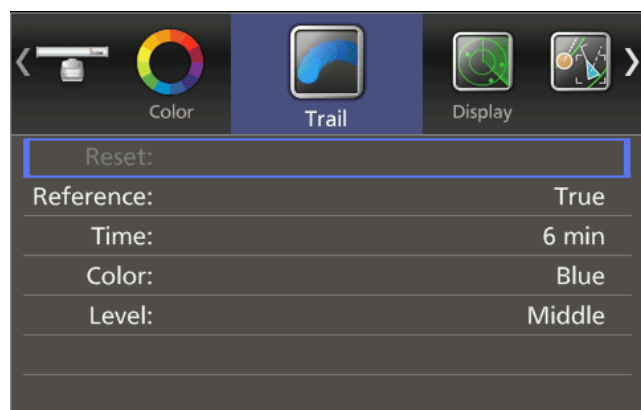

Reset

Clears the trail. When the trail function is OFF, this setting is grayed out.

1. Push [ENTER]/[确认].
2. Push [◀] to select <OK>.
3. Push [ENTER]/[确认] again to clear the trail.

Reference (Default: True)

- True: The trail of other vessels displays a real movement over ground regardless of the movement of your vessel. The true trail requires a heading signal and your own vessel's position information, therefore a stopped target's trail is not displayed.
- Relative: The trail of other vessel's is relative to your vessel.

Time (Default: 6 min)

Selects the trail time from 30 seconds, 1 minute, 3 minutes, 6 minutes, 15 minutes, 30 minutes, or ∞.

Color (Default: Blue)

Sets the trail color to between Blue, Yellow, Green, Red, Orange, and White.

Level (Default: Middle)

Specifies the level of the trail.

- Low: Leaves a trail between Low and High levels.
- Middle: Leaves a trail between Mid and High levels.
- High: Leaves a trail only at the High level.

Display menu

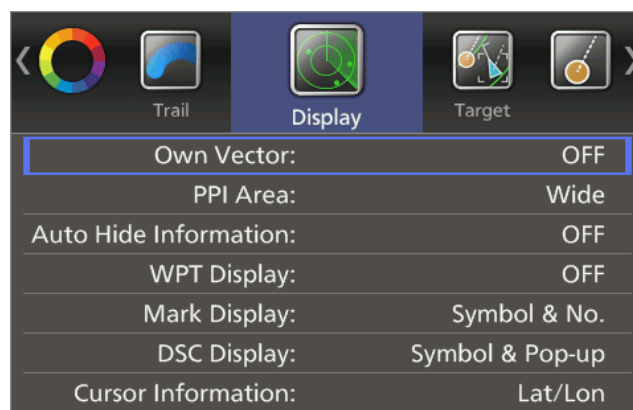

Own Vector (Default: OFF)

- OFF: Does not display your own ship's vector.
- ON: Displays your own ship's vector.
Bearing data and ship speed are required.

PPI Area (Default: Wide)

Selects the PPI (Plan Position Indicator) area.

- Normal: The PPI area is inside the scale.
- Wide: The PPI area is the whole screen.

Auto Hide Information (Default: OFF)

Sets whether after no operation is performed for 10 seconds, the MR-1010RII hides the outside of the scale or not.

This setting is effective only when the "PPI Area" item is set to "Wide."

- OFF: Always displays the outside of the scale.
- ON: Hides the outside of the scale after no operation is performed for 10 seconds, and displays it again when any operation is performed.

WPT Display (Default: OFF)

Sets whether the MR-1010RII displays waypoints or not.

Mark Display (Default: Symbol & No.)

Sets whether the MR-1010RII displays marks or not.

- OFF: The marks are not displayed.
- Symbol: The marks are displayed with icons.
- Symbol & No.: The marks are displayed with icons and numbers.

DSC Display (Default: Symbol & Pop-up)

Sets whether the MR-1010RII displays DSC information or not.

- OFF: DSC information is not displayed.
- Symbol: A Symbol is displayed.
① When "Symbol" is selected, the alarm does not sound even if a DSC has been received.
- Pop-up: DSC information pops up.
- Symbol & Pop-up: A symbol and pop-up are displayed.

■ Display menu (Continued)

Cursor Information (Default: Lat/Lon)

Selects the information displayed in the cursor box on the bottom right of the screen.

- Lat/Lon: Displays the latitude and the longitude.
- TTG: Displays the time to go.

■ Target menu

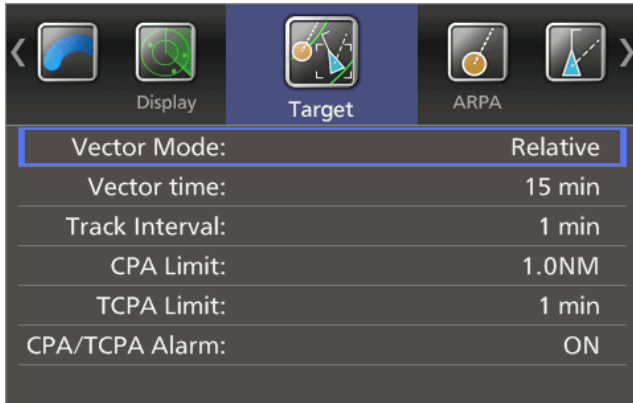

Vector Mode (Default: True)

- True: Selects the true vector mode.
- Relative: Selects the relative vector mode.

Vector time (Default: 6 min)

Sets the vector length (time) to 30 seconds, 1 minute, 3 minutes, 6 minutes, 15 minutes, or 30 minutes.

Track Interval (Default: 1 min)

The track data is updated at this specified tracking interval. Sets the track interval 15 seconds, 30 seconds or between 1 and 15 minutes.

After 5 dots are displayed, the oldest dot disappears at the time when the next dot is displayed.

CPA* Limit (Default: 1.0 NM)

Sets the CPA (Closest Point of Approach) limit to between 0.1 and 12.0 NM in 0.1 NM steps.

TCPA* Limit (Default: 1 min)

Sets the TCPA (Time to CPA) limit time to 30 seconds, between 1 and 6 minutes, or 12 minutes.

*CPA/TCPA: Closest Point of Approach and Time to Closest Point of Approach limits are set to give a warning when a target or targets enter those limits around your own vessel.

CPA/TCPA Alarm (Default: ON)

Sets whether the MR-1010RII sounds the CPA/TCPA alarm, or not.

A CPA/TCPA alarm sounds when both the CPA and TCPA reach the limit.

■ ARPA menu

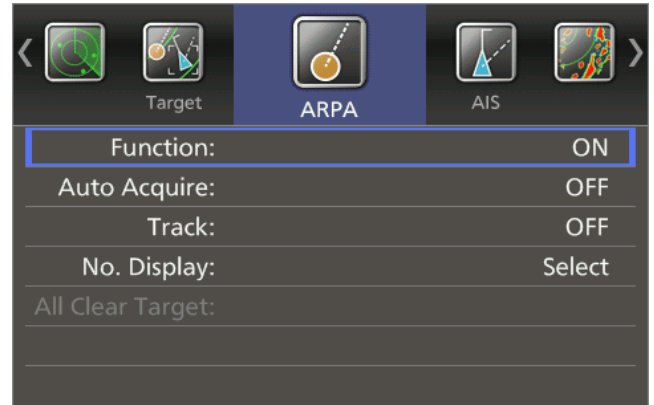

Function (Default: ON)

- OFF: Turns OFF the ARPA (Automatic Radar Plotting Aid) function.
- ON: Turns ON the ARPA function.

Auto Acquire (Default: OFF)

Sets whether the MR-1010RII automatically acquires targets or not.

- OFF: Does not automatically acquire a target.
- ON: Automatically acquires up to 5 targets.

Track (Default: OFF)

The plot displays the target's past positions as 5 dots, during each specified tracking interval.

You can specify the track interval in the "Track Interval" item of the Target menu.

- OFF: Does not display the target tracks.
- ON: Displays target tracks.

No. Display (Default: Select)

Selects the target identification number type that is displayed at the right side of the mark.

- OFF: Does not display any mark number.
- Select: Displays only the selected mark number.
- All: Displays all mark numbers.

All Clear Target

Release all of the ARPA targets at the same time. When there is no ARPA acquired target, this setting is grayed out.

1. Push [ENTER]/[确认].
2. Push [◀] to select <OK>.
3. Push [ENTER]/[确认] again to release all ARPA targets.

■ AIS menu



Display (Default: ON)

Turns the AIS Display function ON or OFF when the MR-1010RII is in Transmitting (TX) mode.

- OFF: Turns OFF the AIS display.
- ON: Turns ON the AIS display.

NOTE: If an AIS target reaches the CPA and TCPA limits when "OFF" is selected, this setting is automatically turned ON.

Track (Default: OFF)

The plot displays the AIS target's past positions as 5 dots, during each specified tracking interval.

You can specify the track interval in the "Track Interval" item of the Target menu.

- OFF: Turns OFF the Track display function.
- ON: Turns ON the Track display function.

Name Display (Default: OFF)

Selects the AIS target display type.

- OFF: Does not display any name or MMSI number of the target.
- Select: Displays the vessel name or MMSI number of the selected target.
- Active: Displays the vessel name or MMSI number of all active targets.

Auto Activate (Default: ON)

The Auto Activate function automatically changes the sleeping AIS target to an activated target when the AIS target is at the specified distance and angle.

You can specify the distance and angle in the next two items.

- OFF: Turns OFF the Auto Activate function.
- ON: Turns ON the Auto Activate function.

Auto Activate - Distance (Default: 1.0 NM)

Sets the distance to automatically changes the sleeping AIS target to an activated target.

- 0.1 to 10.0 NM: Select the distance from your vessel.

Auto Activate - Angle (Default: $\pm 180^\circ$)

Sets the angle to automatically change the sleeping AIS target to an activated target.

- 5 to 180° : Select the angle with your vessel.

New Target Warning (Default: OFF)

Sets whether the MR-1010RII gives a warning when the Auto Activate function automatically changes the sleeping AIS target to an activated target, or not.

- OFF: Does not give a warning when the Auto Activate function activates the target.
- ON: Gives a warning when the Auto Activate function activates the target.

Display Range (Default: 8.0 NM)

Sets the AIS targets display range to between 0.1 and 36.0 NM, or ∞ .

- 0.1 to 36.0 NM: Select the range from your vessel in 0.1 NM steps.
- ∞ : Displays all ranges from your vessel.

Number of AIS (Default: 100)

Selects the maximum number of AIS targets that can be displayed on the screen to between 10 and 100 in 1 target steps.

Slow Warn (Default: ON)

The AIS unit calculated Course Over Ground (COG) data of a vessel that is at anchor or drifting is unreliable, and therefore Closest Point of Approach (CPA) and Time to CPA (TCPA) data may not be correctly calculated. If a vessel is anchored in your alarm zone, the unreliable data can cause the collision alarm to sound many times, even if there is no real danger. To prevent this, when the anchored vessel's Speed Over Ground (COG) is less than this set value, the Slow Warn function assumes that vessel's COG is fixed towards your vessel and an alarm will sound.

- OFF: Turns OFF the Slow Warn function.
- ON: Turns ON the Slow Warn function.

Slow Warn Speed (Default: 0.1 kn)

- 0.1 to 5.0 kn: Selects the vessel's speed in 0.1 kn steps.

■ AIS menu (Continued)

Erase Lost Target

Clears all of the Lost targets at the same time. When there is no lost targets, this setting is grayed out.

1. Push [ENTER]/[确认].
2. Push [◀] or [▶] to select <OK>.
3. Push [ENTER]/[确认] again to clear all of the Lost targets on the screen.

About “Lost Target”: A vessel is regarded as a “Lost target” after a specified period of time has passed since the vessel last transmitted data, as described on page 28.

The “Lost target” icon disappears from the screen 6 minutes and 40 seconds after the vessel was regarded as a “Lost target.”

■ Video menu



TUNE (Default: AUTO)

- Auto: Automatic tuning selection.
 - “TUNE (AUTO)” is displayed in the upper right corner of the screen.
- Manual: Manual tuning selection.
 - “TUNE (MAN)” is displayed in the upper right corner of the screen.

Manual TUNE

When “Auto” is selected in the “TUNE” item, this setting is disabled.

1. Push [ENTER]/[确认] to enter the adjustment mode.
2. Push [◀] or [▶] to adjust the level (63 levels).
3. Push [ENTER]/[确认] again to save and exit the adjustment mode.

Dynamic Range (Default: Middle)

Selects the dynamic range of the Plan Position Indicator (PPI).

- Narrow: Narrow dynamic range. Even weak reflections are displayed as strong reflections.
- Middle: Mid dynamic range.
- Wide: Wide dynamic range. You can easily distinguish between weak reflections and strong reflections.

IR (Default: 2)

- OFF: Turns OFF the Interference Reduction function.
- 1 or 2 (ON): Turns ON the Interference Reduction function 1 (Low) or 2 (High).
 - ① “IR1” or “IR2” is displayed in the upper right corner of the screen.

Echo Stretch (Default: OFF)

- OFF: Turns OFF the echo stretch function.
- ON: Turns ON the echo stretch function. “ES” is displayed in the upper right corner of the screen.

Pulse Width (Default: SP)

- SP: Sets the pulse width to narrow.
- LP: Sets the pulse width to wide. “Ⓟ” is displayed in the upper left corner of the screen.

SEA Curve (Default: 2)

The SEA knob can be used to fine tune the sea clutter of the display after one of four main levels (1 to 4) is selected based on the sea conditions.

Antenna Height (Default: 15 m)

Sets the antenna height from the surface of the sea, according to your antenna installation.

- 5 m, 10 m, 15 m, 20 m, 30 m, 40 m, or 50 m is selectable.

■ System menu



Key Beep (Default: ON)

- OFF: Turns OFF* the beep tone.
- ON: Turns ON the beep tone.
- * Except for the alarm function.

Sync Backlight (Default: OFF)

Sets whether to synchronize the brilliance of the display and the key backlights or not.

- OFF: Individually sets the brilliance of the display and key backlight. (16 levels each)
- ON: Synchronizes the brilliance of the key backlight to the display. (16 levels)

HL OFF Mode (Default: Heading Line)

Selects the objects which are temporarily hidden while [HL-OFF] is hold down.

- Heading Line: Hides the Heading line.
- All: Hides the Heading line, Rings, and other objects.

Zone Alarm 1 / 2 (Default: IN)

Sets the Zone Alarm 1 and Zone Alarm 2 functions.

- IN: An alarm sounds when the target comes into the zone.
- OUT: An alarm sounds when the target goes out of the zone.

Zone Alarm Level (Default: Middle)

Selects the target detection parameter of zone alarm 1 and 2. Low, Middle or High is selectable.

OFF Center Mode (Default: 50%)

Sets the center position of the display when pushing [OFF-Cent].

- 25, 50, 75%: The center position shifts to behind the vessel, and the bow view increases.
- Cursor: The center shifts to the cross-line cursor position.

Save Time (Default: 6 min)

Sets the standby time during the save mode to 1 min, 6 min, 15 min or 30 min.

- ① TX interval scan in the save mode is fixed at 10 revolutions.

Bearing Mode (Default: True)

Selects the displayed bearing type, regardless of the bearing data format (NMEA, N+1, AUX or GPS).

- True: True North bearing.
- Magnetic: Magnetic North bearing.

Variation (Default: Auto)

Selects the difference setting between true North and magnetic North.

- Auto: Automatically revises magnetic variations. Uses 0° for the difference between true North and magnetic North, until an effective variation is received. After an effective variation is received, the received data is valid until you turn OFF the MR-1010R11.
- Manual: Manually revises magnetic variation. Use the manual setting for the difference between true North and magnetic North. Set the Manual Variation in the next item.

Manual Variation (Default: 0.0°E)

Manually sets the difference between true North and magnetic North. Selectable angles are 180.0°W (West) to 180°E (East).

This setting is used when "Variation" is set to "Manual."

Bearing Reference (Default: 360°R)

Sets the direction for the EBL (Electronic Bearing Line) or cursor.

- True: True or magnetic direction.
- 360°R: Relative direction
- PT/SB: Bow direction

Speed Input (Default: SOG)

- SOG: Uses the SOG to calculate TTG (Time To Go).
① GPS data (NMEA) is required.
- Manual: Uses the manual speed to calculate TTG. Set Manual Speed, Manual SET, and Manual Drift items below.

Manual Speed (Default: 10.0 kn)

Sets your vessel's speed to between 0.1 and 40.0 kn (0~74.0 km/h).

Manual SET (Default: 000.0°T)

Sets the Tidal current direction to between 0 and 359.9°.

Manual Drift (Default: 0.0 kn)

Sets the Tidal current speed to between 0 and 20.0kn (0~37.0 km/h).

■ System menu (Continued)

TLL Mode (Default: Output & Symbol)

Sets the action when [TLL] is held down for 1 second.

- Output: Outputs the position information where the cursor is positioned, to the NMEA output terminals.
- Symbol: Marks on the screen where the cursor is positioned.
- Output & Symbol: Outputs the position information and marks on the screen where the cursor is positioned.

Standby Mode (Default: Normal)

Sets the display information in the Standby mode to Normal or AIS.

Rev.

Displays the revision number of the MR-1010RII firmware.

■ Initial menu

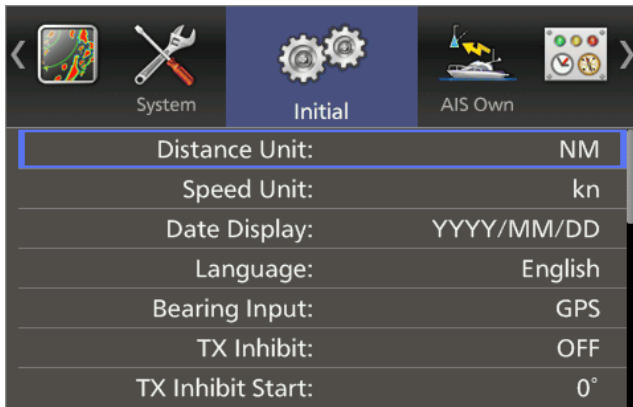

Distance Unit (Default: km)

Selects the unit of distance from NM (Nautical miles) or km (Kilometers).

① You can change this setting only while the MR-1010RII is in the Standby mode.

Speed Unit (Default: kn)

Selects the unit of speed from kn (Knots) or km/h (Kilometers / hour).

Date Display (Default: YYYY/MM/DD)

Selects the Date display type from “YYYY/MM/DD,” “MM/DD/YYYY,” or “DD/MM/YYYY.” (YYYY: Year, MM: Month, DD: Day)

Language

Selects the display language. (p. 34)

Bearing Input (Default: GPS)

Sets the input source of the vessel's bow information.

- NMEA: NMEA0183 bearing data format.
- N+1: N+1 data format.
- AUX: Other format.
- GPS: Reads NMEA0183 COG (Course Over the Ground) format data as HDG format. (The course may not match with other HDG format and includes errors.)

① When a Vessel's speed is less than 2 knots, the direction information is not displayed until the speed increases to more than 3 knots.

GPS-L: Reads NMEA0183 COG format data as HDG format. (The course may not match with other HDG format and includes errors.)

① When a vessel's speed is less than 2 knots, the direction information information is fixed. The display changes only when the vessel's speed increases to more than 3 knots.

① This is in addition to the GPS option to display the cursor latitude and longitude when the vessel's speed is less than 3 knots.

TX Inhibit (Default: OFF)

Selects whether the MR-1010RII uses TX inhibit or not.

TX Inhibit Start (Default: 0°)

Sets the start point of the TX inhibit area to between 0 and 359°.

TX Inhibit Angle (Default: 1°)

Sets the TX inhibit area to between 1° and 90°.

Timing Adjust

Adjusts the sweep timing. (p. 35)

Heading Adjust (Default: 0°)

Adjusts the Bow compensation between -180° and +180°. (p. 36)

Antenna Rotation Speed (Default: Normal)

Selects the antenna rotation speed from Normal or Slow. (p. 35)

Range Ring (Default: Ring1)

Selects the number of displayed rings in range.

- Ring1: 2~4 rings in range.
- Ring2: 2~6 rings in range.

Range

Sets the effective ranges. (p. 37)

1. Push [ENTER]/[确认] to enter the option selection mode.
2. Push [▼] or [▲] to select a range.
3. Push [◀] to set the range OFF or push [▶] to set the range ON.
4. Push [ENTER]/[确认] to save the settings.

Save Settings 1 / 2 / 3

The settings can be saved. (p. 37)

1. Push [ENTER]/[确认].
2. Push [◀] to select <OK>.
3. Push [ENTER]/[确认] to save the settings.

Load Settings 1 / 2 / 3

The saved setting can be loaded. (p. 37)

1. Push [ENTER]/[确认].
2. Push [◀] to select <OK>.
3. Push [ENTER]/[确认] to load the settings.

Setting Reset

Resets the settings in the Menu screen other than the settings in the Initial menu. You can reset only while the MR-1010RII is in the Standby mode. (p. 38)

1. Push [ENTER]/[确认].
2. Push [◀] to select <OK>.
3. Push [ENTER]/[确认] to reset the settings.

Factory Reset

Resets the MR-1010RII to the factory default. You can reset only in the Standby mode. (p. 38)

1. Push [ENTER]/[确认].
2. Push [◀] to select <OK>.
3. Push [ENTER]/[确认] to load the factory default.

■ AIS Own menu



Displays own AIS information.

■ Status menu

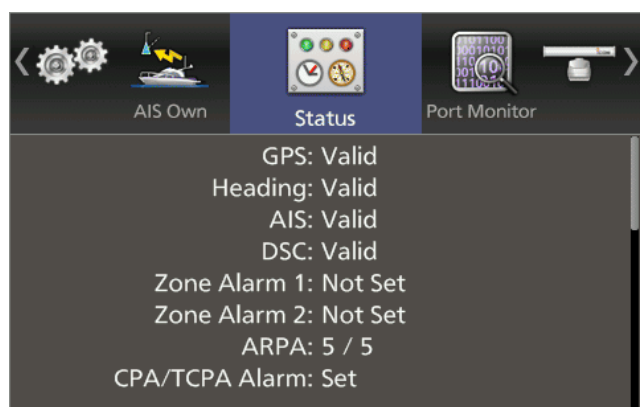

Displays the status of the GPS, Heading, AIS, and DSC inputs, alarm settings, number of acquirable ARPA, and CPA/TCPA alarm settings.

- ① The ARPA indicates the remaining number of the targets you can acquire and then the maximum number you can acquire. (For example, 2/5 indicates the three targets have already been acquired, out of a maximum of 5, and therefore two more target can be acquired.)
- ② The CPA/TCPA Alarm Set item indicates the number of dangerous targets in the total number of targets.

■ Port Monitor menu



Displays the status of the input/output ports.

1. Push [▲] or [▼] to select a port.
2. Push [ENTER]/[确认] to open the detail window.
 - The display status is automatically updated.
 - ① Push [ENTER]/[确认] to pause the display update. Push again to restart.
3. Push [CLEAR]/[取消] to close the window.

■ Scanner Monitor menu

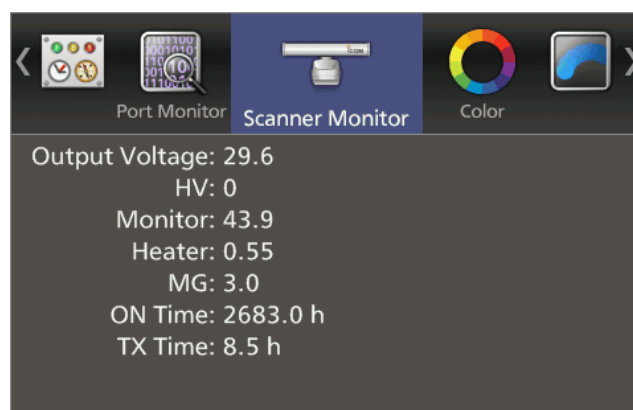

Displays the scanner status. When the status is out of the range, the title and the value change to red color.

Radar uses a form of electromagnetic radiation that can be reflected off a large vessel, bridge, or other metal objects that are in proximity. Because of this property, unwanted reflections off some objects may cause false echoes to appear on the screen where in fact no actual targets exist. Operators should be familiar with the effect of this phenomena. In some cases, echoes can be reduced.

■ Sidelobe echoes

Radiation can escape on each side of the beam inside the sidelobes. If a target reflects this radiation, it will be displayed on the screen as an echo.

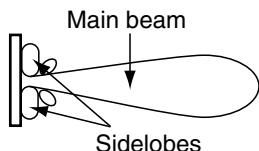

Sidelobe echoes usually occur at short ranges and as a result of large (strongly reflective) targets. They can be reduced with proper adjustment of the **SEA** / 海浪抑制 control.

See page 9 for details of the **SEA** / 海浪抑制 control.

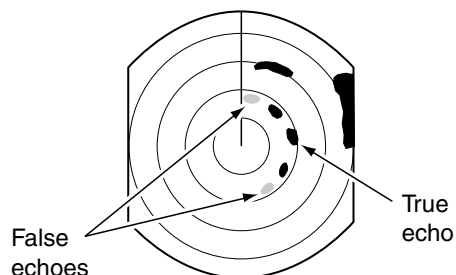

■ Indirect echoes

Indirect echoes may be returned from either a passing vessel, or returned from a reflecting surface, such as a mast on your own vessel.

An indirect echo from a reflective surface will appear on a different bearing from the direct (true) echo, but the distance will be approximately the same for both.

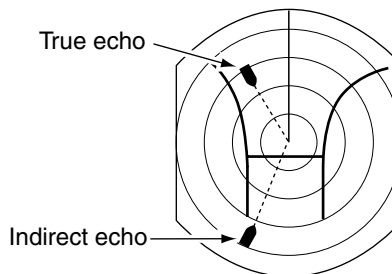
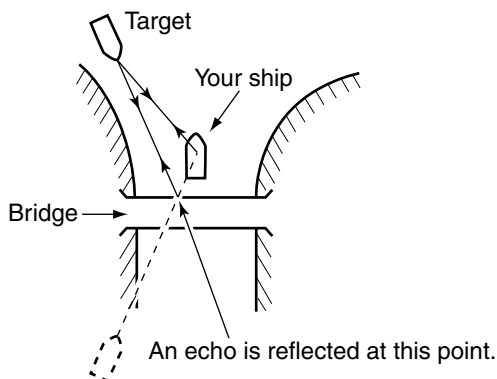
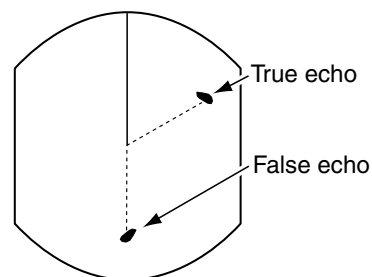
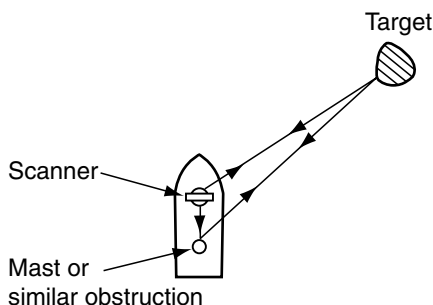

Multiple echoes

Multiple echoes may appear when a short-range and strong echo is received from a vessel, bridge, or breakwater.

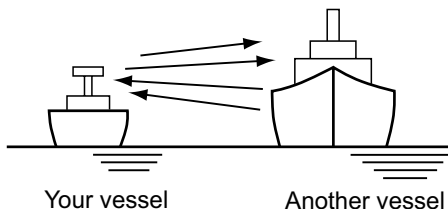

Multiple echoes will appear beyond the target's true echo point on the same bearing of a large target. They can be reduced with proper adjustment of the **SEA** / 海浪抑制 control.

See page 9 for the **SEA** / 海浪抑制 control.

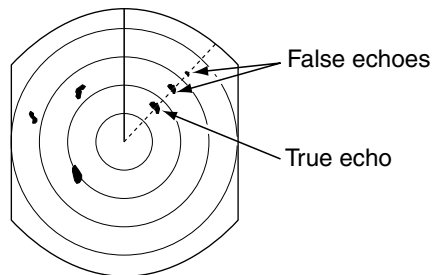

Minimum range

Detection at short range is very important. Minimum range is determined primarily by transmitter pulse length, vertical beam width and height of the scanner unit. The shorter the transmission time, the quicker the return echoes can be received and their distance measured.

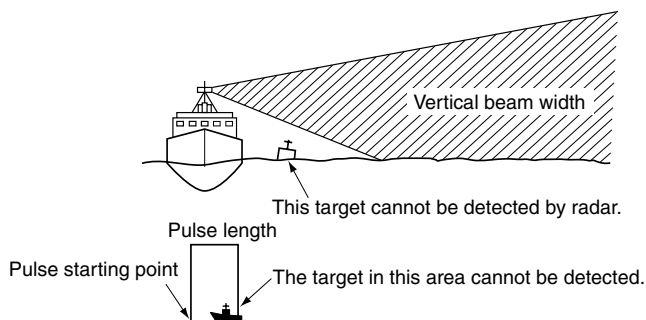

The ability to see targets very close to the vessel is decreased if the scanner is mounted too high off the water, because the bottom of the vertical beam of the scanner overshoots nearby targets.

9

Blind and Shadow sectors

Blind or Shadow sectors may exist because of obstructions such as masts, derricks or other metal objects. An obstruction may throw either a complete or partial shadow as shown in the diagram below. If a target is in a shadow sector, target echoes may not appear on the screen.

Shadow sector

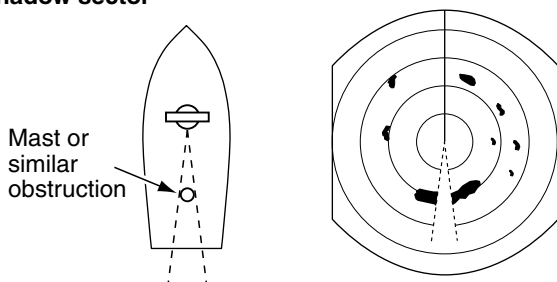

When tall and massive targets such as a large island are located at close range are also shadowed without producing any echoes. This phenomenon is called blind sector. It is very important to know the bearings and widths of all shadow sectors caused by your own vessel's obstructions.

Blind sector

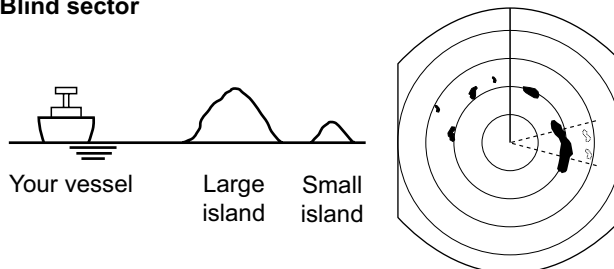

■ Target resolution

Target resolution is determined by the horizontal beam width and transmit pulse width. Sometimes it is difficult to detect two targets that are separated by short distances or are in the same direction.

◇ Distance resolution

When two targets are separated by more than the pulse width, they appear as two echoes.

When two targets are not separated by more than the pulse width, they appear as 1 echo.

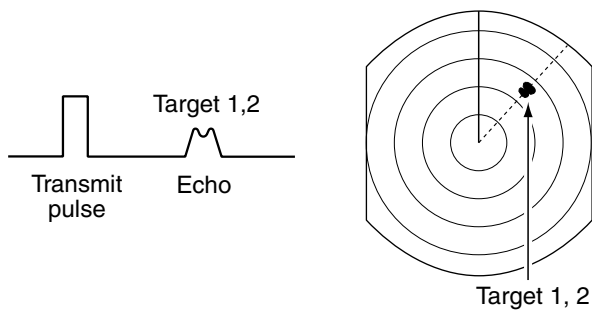
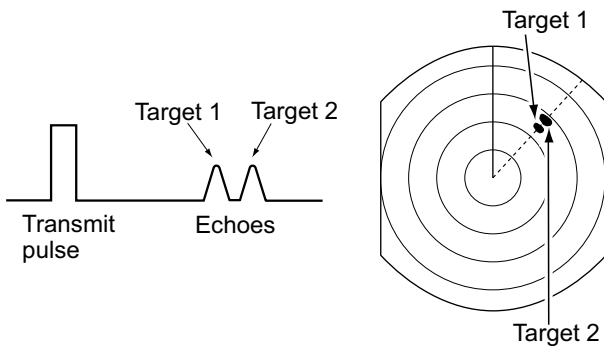

◇ Direction resolution

When two targets are separated by more than the horizontal beam width, they appear as two echoes.

When two targets are not separated by more than the horizontal beam width, they appear as one echo.

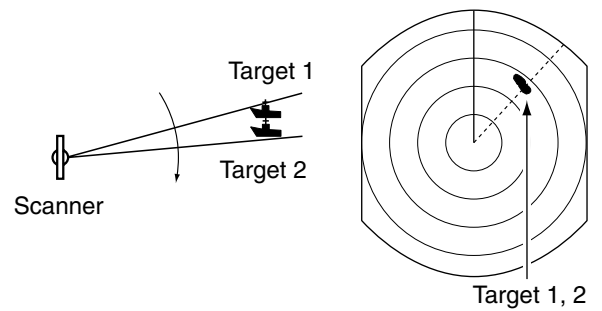
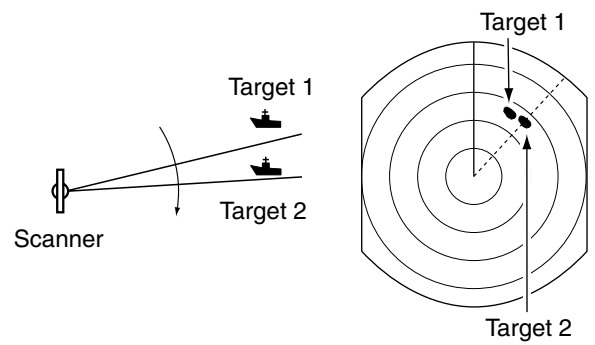

■ Periodic maintenance

Continued, reliable operation of the radar depends on how you care for it. The simple maintenance tips that follow can help you save time and money, and avoid premature equipment failure.

⚠ WARNING! BE SURE to turn OFF the radar before performing any maintenance.

1. Keep the equipment as clean as possible.
 - ① Use a soft cloth to remove dirt, dust and water.
2. Check all hardware for loose screws, bolts, and so on.
3. Check the cables and the terminal connections.

■ Display unit maintenance

⚠ WARNING! BE SURE to turn OFF the radar before working on it.

◇ Cleaning

Wipe the surface of the display unit with a clean soft cloth. If the LCD is dirty, a film of contaminants may form, and the screen may darken.

1. Wipe the surface of the display unit with a clean soft cloth.

CAUTION: DO NOT use harsh solvents such as Benzine or alcohol.

2. If the picture is still dim, clean the LCD screen.

■ Fuse replacement

At default, a 15 A fuse is installed in the supplied DC power cable. If the fuse blows or the transceiver stops functioning, track down the source of the problem, repair it, and replace the damaged fuse with a new one of the proper rating.

Fuse rating: 15 A (for 12 V DC) or 5 A (for 24 V DC)

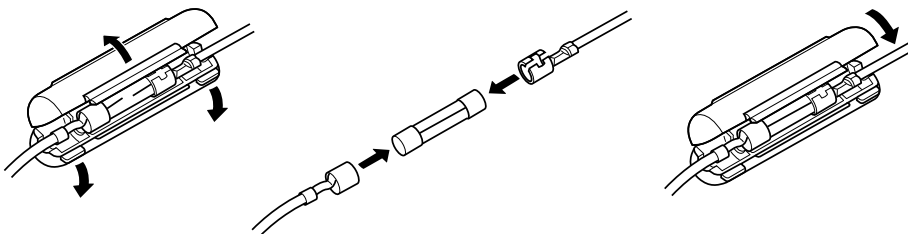

■ Scanner unit maintenance

◇ Cleaning

1. Wipe the surface of the scanner with a clean soft cloth.

CAUTION: DO NOT use harsh solvents such as Benzine or alcohol.

2. Check that there is no dirt or caked-on salt.
 - ① A heavy deposit of dirt or caked-on salt on the painted surface of the top of the scanner unit will cause a considerable drop in radar performance.
3. Check for cracks or deterioration of the rubber packing and replace it if necessary.

◇ Mounting

Check the mounting bolts of the scanner unit and tighten them if necessary.

■ Error message list

Message	Condition
Check Scanner Connection* ¹	The system cable may not be properly connected.
Communication error (Scanner)	The data from the Scanner unit can be received, but it is incorrect data. This is possibly a bad cable or bad connection, or a malfunction from other equipment noise.
Trigger Signal Fail* ²	If the Trigger signal is interrupted for more than 15 seconds while in the TX mode, an alarm sounds.
SHM Signal Fail* ³	If the SHM signal is interrupted for more than 15 seconds while in the TX mode, an alarm sounds.
Heading Data is not available. * ²	The Azimuth signal is interrupted. An alarm sounds within 5 seconds and the display reverts to H-UP mode in approximately 1 minute.
Position Data is not available. * ²	If the position signal is interrupted for more than 15 seconds, an alarm sounds.

*¹ Turn OFF the power, then check the system cable connections.

*² Push any key to cancel the error message and beep tone. Turn OFF the power, then check the external data cable connection.

*³ An electricity failure may have occurred. Turn OFF the power, then consult your dealer or service person.

■ AIS error message list

An error message is displayed when a system error is received from the AIS unit. See the AIS unit instructions for details.

(Some examples)

Message contents
AIS: TX MALFUNCTION
AIS: ANTENNA VSWR EXCEEDS LIMIT
AIS: RX CHANNEL 1 MALFUNCTION
AIS: RX CHANNEL 2 MALFUNCTION
AIS: RX CHANNEL 70 MALFUNCTION
AIS: GENERAL FAILURE
AIS: MKD CONNECTION LOST
AIS: EXTERNAL EPFS LOST
AIS: NO SENSOR POSITION IN USE
AIS: NO VALID SOG INFORMATION
AIS: NO VALID COG INFORMATION
AIS: HEADING LOST/INVALID
AIS: NO VALID ROT INFORMATION

Only the first 29 digits of the error message are displayed. If the message is longer than 30 digits, “...” is displayed after the 29th digit.

■ General

- Minimum range: 25 m, 82 ft (when measurement range is 1/8 NM)
- Maximum range: 36 NM
- Measurement range: 1/8, 1/4, 1/2, 3/4, 1, 1.5, 2, 3, 4, 6, 8, 12, 16, 24, 32, 36 (NM)
- Preheat time: 90 seconds
- Connection length between display and scanner units: 15 m, 49.2 ft

■ Display unit

- LCD display: 10.4-inch TFT Color LCD
- Resolution: 480 × 640
- LCD mounting: Vertical
- Input: NMEA 0183 format (for navigation receiver), N+1 format (fluxgate compass sensor), AUX, IEC61162-2 format (for AIS unit)
- Output: NMEA 0183 format
- Power supply requirement: 12 V or 24 V DC (Power requirement: 10.2 ~ 42 V DC)
- Power consumption (at zero wind velocity): Approximately 55 W
- Usable temperature range: -15°C ~ +55°C, +5°F ~ 131°F
- Dimensions (Including the mounting bracket): 301 (W) × 323.5 (H) × 119.2 (D) mm, (Projections not included) 11.8 (W) × 12.7 (H) × 4.7 (D) inch
- Weight (Mounting bracket is included): Approximately 4.3 kg, 9.5 lb

■ Scanner unit (EX-2714)

- Type: 60 cm (2 ft.) Slotted Waveguide Array, enclosed in a radome.
- Rotation speed (typical): 24 rpm, 36 rpm
- Beam width (typical): Horizontal beam 4°
Vertical beam 22°
- Side lobe (typical): -22 dB
- Polarization: Horizontal
- Transmission frequency: 9410 MHz ±30 MHz P0N
- Peak output power: 4 kW
- Pulse width: 80 ns / 2160 Hz, 80 ns / 1440 Hz, 250 ns / 1440 Hz, 350 ns / 1440 Hz, 900 ns / 720 Hz
- Mixer and Local Oscillator: Microwave Integrated Circuit
- Transmitting Tube: Magnetron (CHN and EXP versions) MAF1421B, (EUR version) MAF1611B
- Modulator: FET switching
- Duplexer: Circulator
- Tuning system: Automatic / manual selectable
- Intermediate frequency: 60 MHz
- IF Band width: 10 MHz / 3 MHz
- Dimensions: 640 (W) × 256 (H) × 640 (D) mm, 25.2 (W) × 10.1 (H) × 25.2 (D) inch
- Usable temperature range: -25°C to +70°C, -13°F to 158°F
- Relative Humidity: Less than 95% at 40°C (+104°F)
- Weight: Approximately 8 kg, 17.5 lb (without cable)

■ Options

- **OPC-2340 SYSTEM CABLE**
To install the display unit and scanner up to 30 m (98.4 ft) apart.
- **UX-252 VIDEO OUTPUT UNIT** (Except for the EUR version)
To connect an external display or a PC monitor with a VGA connector.
Output method: 640 × 480 analog RGB output

13 EXTERNAL DATA LIST

The following external bearing, speed, position, waypoint, variation, and DSC data is (are) required, when you use the radar functions.

		EXTERNAL DATA INPUT								
		[NMEA1]*1 connector				[NMEA2]*1 connector				
		"THS," "HDG," "HDM," "HDT"		"VDM", "ALR" "VDO"*2		"RMC," "GGA," "GLL," "GNS," "VTG," "WPL," "BWC," "BWR"				"DSC", "DSE"
		N+1, AUX								
FUNCTION	DISPLAY	BEARING	VARIAION	AIS	SPEED	POSITION	WAYPOINT	VARIAION	DSC	
HEAD UP	H-UP	—	—	—	—	—	—	—	—	
COURSE UP	C-UP	Required	—	—	—	—	—	—	—	
NORTH UP	N-UP	Required	—	—	—	—	—	—	—	
TRUE MOTION	TM	Required	—	—	—	"RMC," "GGA," "GLL," or "GNS"	—	—	—	
SPEED DISPLAY	SOG	—	—	—	"RMC" or "VTG"	—	—	—	—	
HEADING BEARING	HDG	Required	—	—	—	—	—	—	—	
WAYPOINT	Waypoint	Required	—	—	—	"RMC," "GGA," "GLL," or "GNS"	"WPL," "BWC," or "BWR"	—	—	
OWN VECTOR	—	Required	—	—	"RMC" or "VTG"	—	—	—	—	
ARPA	ARPA	Required	—	—	"RMC" or "VTG"	—	—	—	—	
Cursor/Waypoint Estimated Time of Arrival	—	—	—	—	"RMC" or "VTG"	—	—	—	—	
MAGNETIC VARIATION (AUTO) *4	—	—	"HDG"	—	—	—	—	"RMC"	—	
TLL	—	Required	—	—	—	"RMC," "GGA," "GLL," or "GNS"	—	—	—	
AIS (Display only)	AIS	Required	—	"VDM"	—	"RMC," "GGA," "GLL," or "GNS"	—	—	—	
AIS (CPA/TCPA Alarm)	AIS	Required	—	"VDM"	"RMC" or "VTG"	"RMC," "GGA," "GLL," or "GNS"	—	—	—	
AIS (OWN)	MENU	—	—	"VDO"	—	—	—	—	—	
Alarm status*3	—	—	—	"ALR"	—	—	—	—	—	
DSC	DSC	Required	—	—	—	"RMC," "GGA," "GLL," or "GNS"	—	—	"DSC", "DSE"	

		EXTERNAL DATA OUTPUT							
		—				[NMEA2]*1 connector			
		—	—	—	—	"RMC," "GGA," "GLL," "VTG," "TTM," "TLL," "RSD," "OSD"			

*1 [NMEA1] and [NMEA2] connectors: See page 54.

*2 AIS input also receives "RMC," "GGA," "GLL," "VTG," and "GNS" sentences.

If the NMEA2 input or DSC input does not receive these, the sentences from the AIS input are used.

*3 The system error is displayed from the AIS unit.

*4 Either an "HDG" to [NMEA1] connector or an "RMC" to [NMEA2] connector is required.

- "THS," "HDG," "HDM," "HDT," "RMC," "GGA," "GLL," "GNS," "VTG," "WPL," "BWC," "BWR," "TTM," "TLL," "RSD," "OSD," "DSC," and "DSE" are sentences of NMEA0183.
- If the "Bearing Input" item in the Initial menu is set to "GPS" or "GPS-L," "RMC" of [NMEA2] connector or COG (Course Over the Ground) of "VTG" a bow it receives as a direction, even if there is no direction information (compass etc.) in [NMEA1] connector, the screen display of the North rise etc. is possible. However, direction accuracy falls when the speed of a vessel is set to 2 knots or less, or when exceeding 3 knots a bow it does not receive as direction data. Moreover, the influence of measurement position accuracy or a current an actual bow it may differ from a direction.

CAUTION! DO NOT turn ON the display unit before both the display unit and the scanner unit is completely installed and connected.

■ Connecting the units

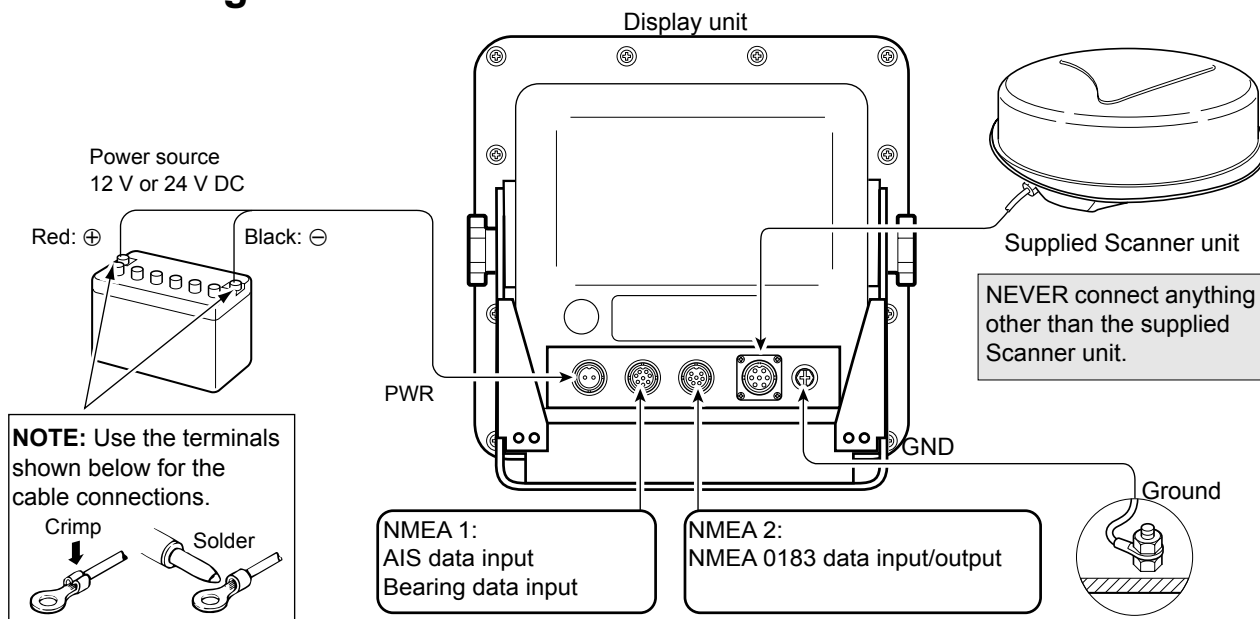

NMEA1 connection (Rear panel view)

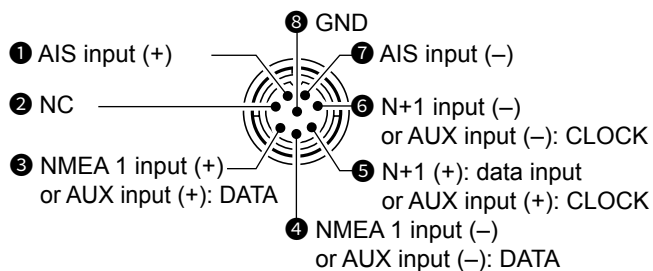

- NMEA 1/2 inputs, NMEA 2 output, DSC input: 4800 bps
- AIS input: IEC61162-2 38400 bps

NMEA2 connection (Rear panel view)

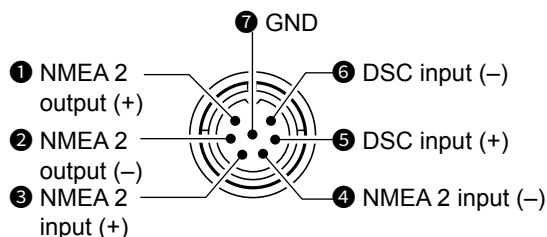

■ Power source requirement

◇ DC power source

You can directly connect the display unit to a 12 V or 24 V DC battery without a DC-DC converter or any internal modifications.

(Power source requirement: 10.2 ~ 42 V DC)

Connect the DC power cable as shown above.

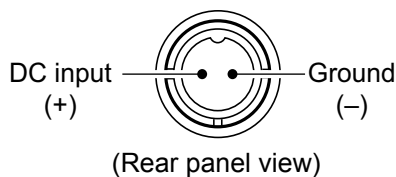

CAUTION: An incorrect cable connection will damage the display unit.

● DC power cable connection

1. If a ferrite EMI filter is supplied, clamp the DC power cable with the ferrite EMI filter attached near the sealing connector, as shown below.

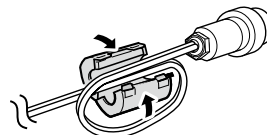

2. Connect the DC power cable as shown in the diagram.

■ Ground connection

To prevent electrical shocks and other problems, ground the display unit through the [GND] terminal. For best results, connect a heavy gauge wire or strap to the nearest grounding point on the vessel. The length of the wire or the strap should be as short as possible.

■ Installing the display unit

◇ Location

Install the display unit in a place that meets the following important conditions:

- Near the wheel in the cabin so that you can easily view the radar screen while facing the bow.
- To minimize interference, keep the distance more than “COMPASS SAFE DISTANCE” (stated in the serial number label on the rear panel) away from the compass and your navigation receiver.
- A safe place from salt or fresh water splash or immersion.
- A place where it is easy to operate the usual maintenance or adjustments.
- A place that can support the weight of the display unit.
- Do not locate the display unit subject to extreme heat, cold, vibrations or direct sunlight.

◇ Mounting the bracket

The mounting bracket supplied with the display unit enables “dashboard” or “overhead” mounting.

1. Hold the mounting bracket up to the selected location and mark pilot holes for the five installation holes using the template on page 62.
2. Drill 5 holes, 7 mm (0.28 inch) in diameter.
3. Install the bracket using the bolts, nuts or washers.

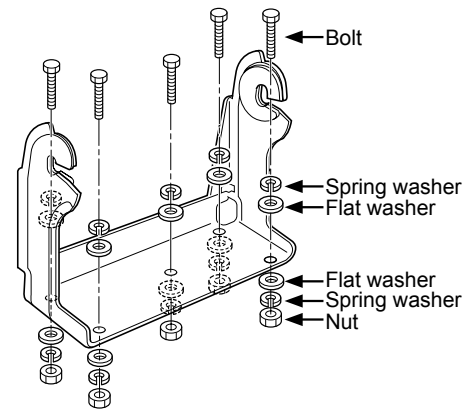

4. Attach the display unit to the bracket with the knob bolts at an appropriate view angle.

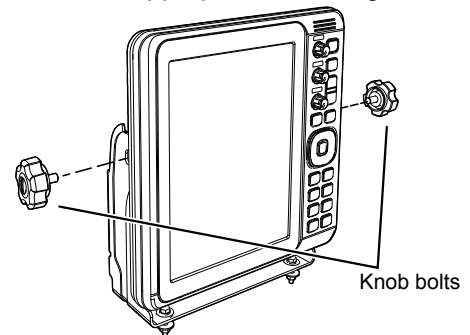

◇ Display unit dimensions

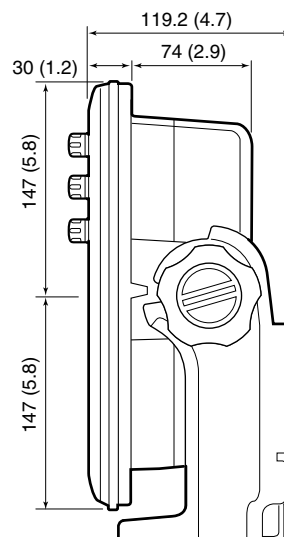
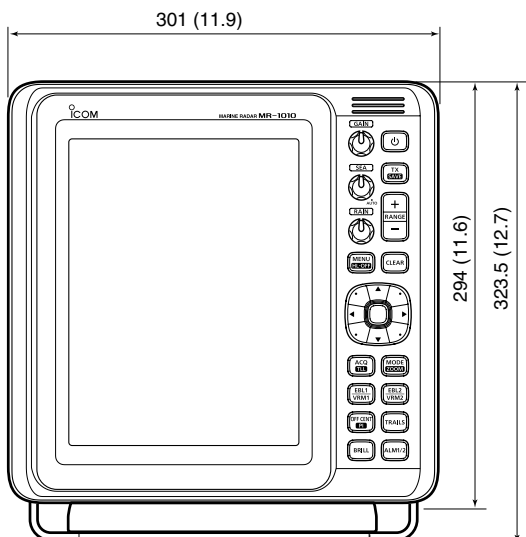

Unit: mm (inch)

◆ Wall Mounting

The display unit can be mounted to a flat surface, such as an instrument panel, using the M6 mounting bolts.

1. Remove the four screw hole seals from the four corners of the display unit.

BE CAREFUL! NEVER use your finger nail to remove the seal. Otherwise, you may injure your nail.

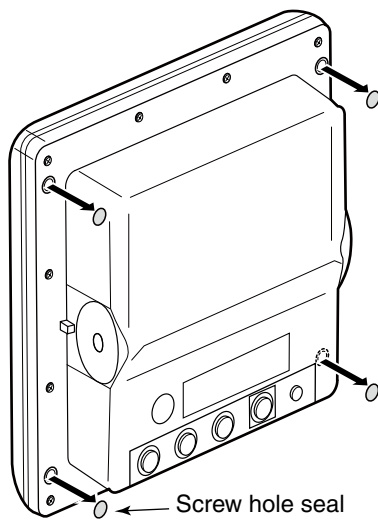

2. Using the display unit template that comes with the display unit, carefully cut a hole in the instrument panel, or wherever you plan to mount the display unit.

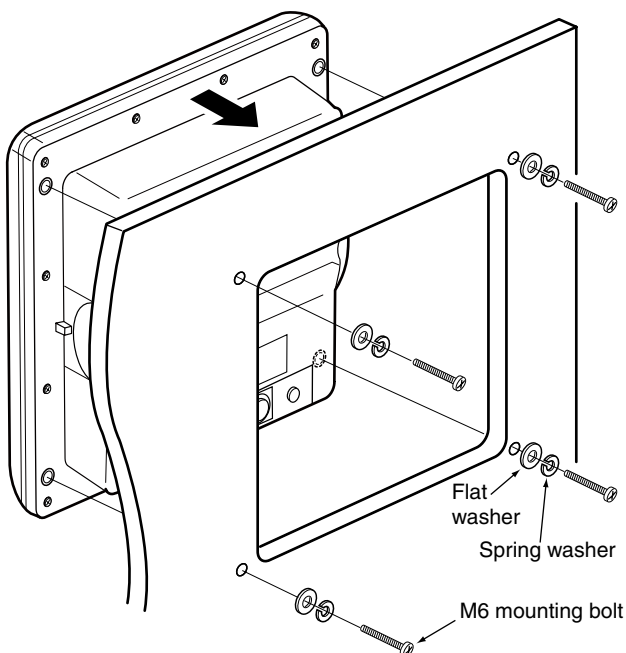

3. Drill four holes for the mounting screw.
 - ① The screw hole depth is 14.5 mm ($\frac{9}{16}$ inches).

4. Slide the display unit through the hole.
5. Attach the four corners of the display unit using the flat washers, spring washers, and M6 mounting bolts.
 - ① Select the mounting bolts of the length that fits the thickness of the instrument panel.

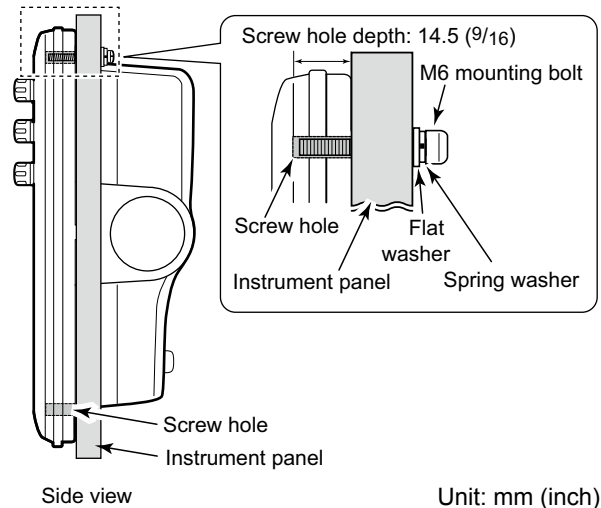

Unit: mm (inch)

■ Installing the EX-2714 scanner unit

◇ Location

The scanner unit is designed for high-pressure water jet resistance (except for the cable connectors). Install the scanner unit in a place that meets the following essential conditions:

- Place the scanner unit horizontally at the vessel's center so that it can view in all directions. Make sure that no objects interfere with the scanning beam.
- Keep the scanner unit away from any exhaust pipes to avoid damaging the unit with exhaust gas.
- If your vessel is equipped with a Radio Directional Finder (RDF) system, keep the scanner unit at least 2 m (6.6 ft) away from the RDF antenna. Radiation from the scanner unit may affect the measurement data of RDF instruments.
- Locate the scanner unit as high as possible on the vessel for maximum performance in the full range. If the height is insufficient to install the scanner unit, build a frame to mount it.
- When installing two or more radars on a vessel, do not place the scanner units at the same height.

◇ Mounting

⚠ WARNING! BE SURE to turn OFF the display unit whenever you are working with the scanner unit.

1. Drill four holes, 12 mm (0.47 inch) in diameter using the EX-2714 template comes with the display unit.
2. If the mounting surface or platform is metal, apply a sealing compound around the holes to prevent corrosion and water infusion.
3. Attach the scanner unit to the selected position with the supplied bolts (M10×50 mm or M10×25 mm; depending on your installation needs), flat and spring washers.
 - ① Secure the four bolts firmly.

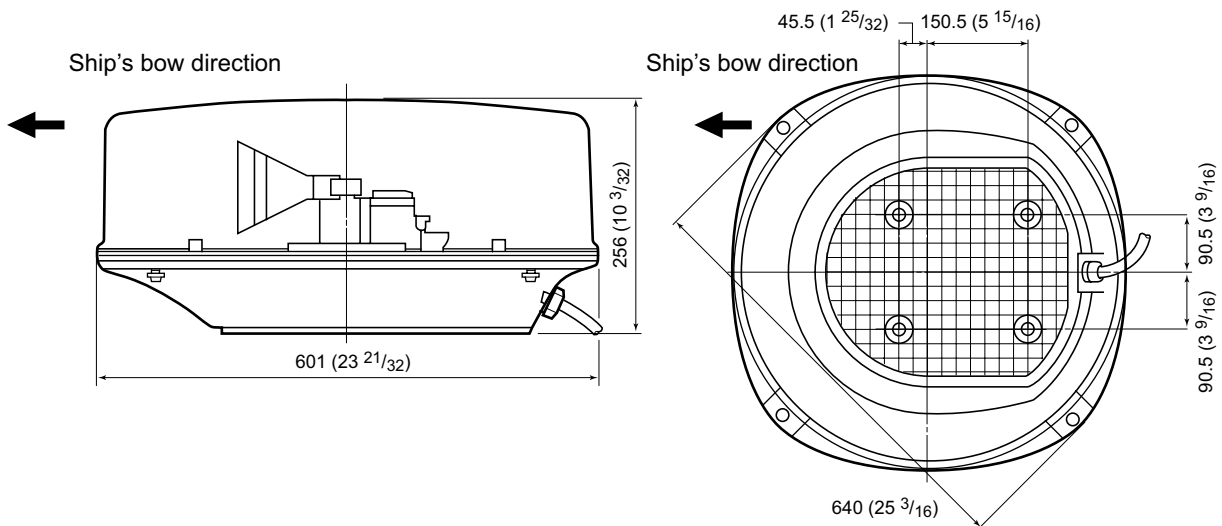

Unit: mm (inch)

◇ Connecting the system cable

⚠ DANGER: HIGH VOLTAGE! High voltages of about 3,500 volts are used in the scanner unit. **CAREFULLY READ** the precautions on page iii before installing the scanner unit.

CAUTION: DO NOT cut the supplied system cable.

1. Using a hex head wrench, loosen the 4 bolts on the bottom of the scanner unit, and remove the cover.
 - ① You can use a Phillips head or flat head screwdriver instead of the hex head wrench.
2. Loosen the sealing nut on the scanner unit, and then pass the system cable through the sealing nut sealing tube, and the scanner body. (1)
3. Insert the black and white PA cable connector into the PA unit connector J1. (2)
4. Connect the shielded cable ground wire to the ground plate with the screw. (3)
5. Clamp the system cable with the ferrite EMI filter attached near the sealing connector.
 - ① Be sure to clamp it tightly. (4)
6. Connect the power cable (black and red) to the power connector. (5)

DO NOT install the system cable too tightly. It may cause contact failure.

7. Tighten the sealing nut.
8. Replace the radome cover over the scanner unit. Be sure that the “▲” mark on the top of the cover faces the vessel's bow.
9. Tighten the four bolts on the bottom of the scanner unit (Torque: 5.0 N•m; 3.69 lbf•ft.)
10. The four protrusions around the radome cover indicates the location of the bolt receptacle.
 - ① the radome cover show the positions of the bolt receptacles.

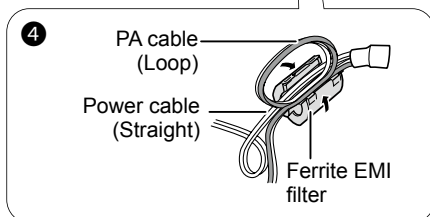
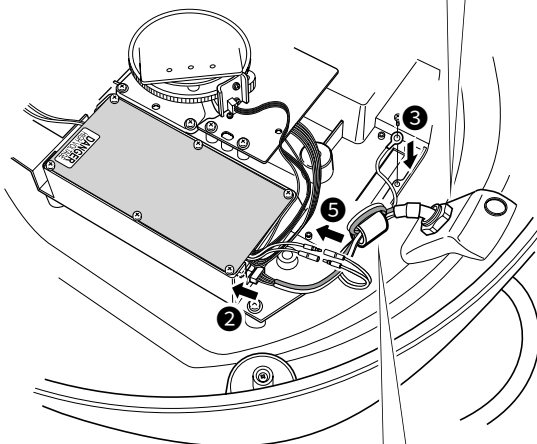
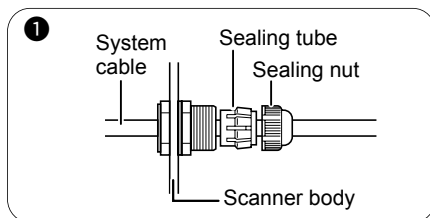
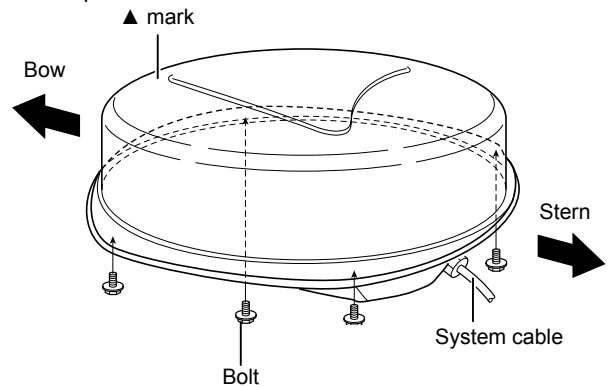

■ Adjusting the settings

After the installation, turn ON the radar and adjust the following settings according to your installation conditions.

Video menu

- Antenna Height
Select the antenna height from the water surface.

Initial menu

- Timing Adjust
Adjusts the sweep timing to display the straight echo.
- Heading Adjust
Adjust the heading marker line to the actual bow direction.

■ Installing the UX-252 Video output unit

① The UX-252 may not be usable, depending on the radar version. Contact your dealer for details.

When an optional UX-252 is installed, the MR-1010RII can be connected to an external display or a PC monitor with a VGA connector.

① The monitor requires the resolution of 640 × 480 dots or higher. Place the monitor in portrait orientation.

⚠ WARNING! BE SURE to disconnect the power cable from the display unit, when you are installing the optional unit.

1. Remove the cable hole seal on the left of the serial number label of the display unit. (Fig. 1)

⚠ DANGER! NEVER use your finger nail to remove the seal. Otherwise, you may injure your nail.

2. Remove the 12 screws from the display unit's rear panel. (Fig. 1)
3. Slowly open the rear case and disconnect the four connectors from the display's main board. (Fig. 1)

CAUTION: DO NOT pull the cables when opening the rear case. This could damage the cables and/or display unit.

- ① One of the connectors has a lock. Hold the release on connector head to disconnect the connector.
4. Pass the video output cable through the hole, then screw in and tighten the sealing tube. (Fig. 2)
5. Connect the video output cable to the connector on the UX-252. (Fig. 3)

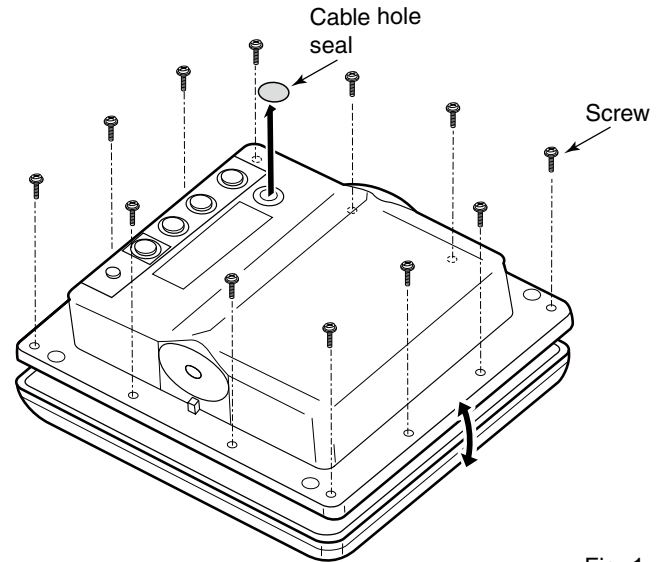

Fig. 1

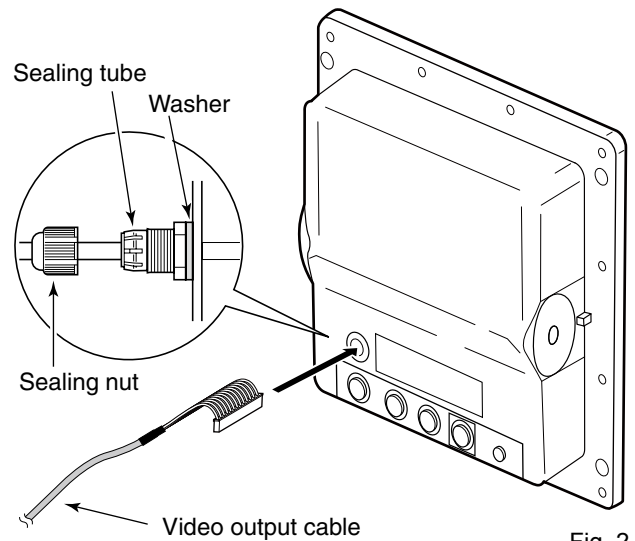

Fig. 2

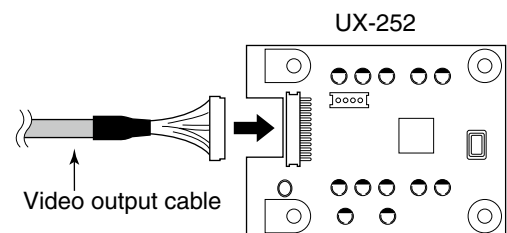

Fig. 3

6. Install the UX-252 on the display's main board using the four screws supplied with the UX-252. (Fig. 4)
 - Before tightening the screws, be sure to connect the UX-252's connector to the display unit's connector.
7. Secure the cable to the UX-252 with a cable tie. (Fig. 5)
8. Clamp the cable with the ferrite EMI filter attached near the UX-252. (Fig. 5)
 - ① Be sure to clamp it tightly.
9. Reconnect the four connectors to the display's main board.
10. Replace the gasket, rear case, and screws their original position.
 - ① Make sure the gasket is properly seated.

CAUTION: DO NOT pinch the cables when closing the rear case. This could damage the cables

11. Adjust the video output cable length and then tighten the sealing nut. (Fig. 6)

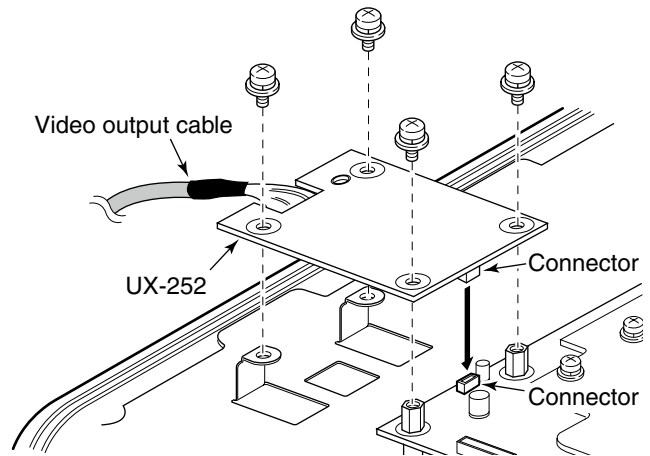

Fig. 4

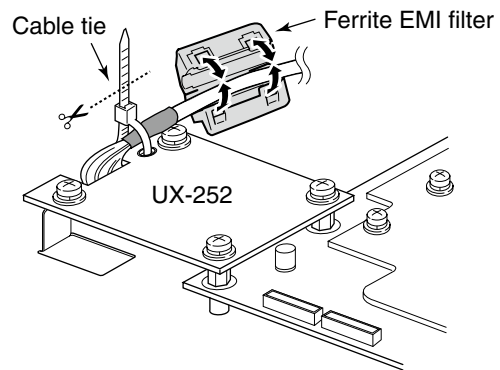

Fig. 5

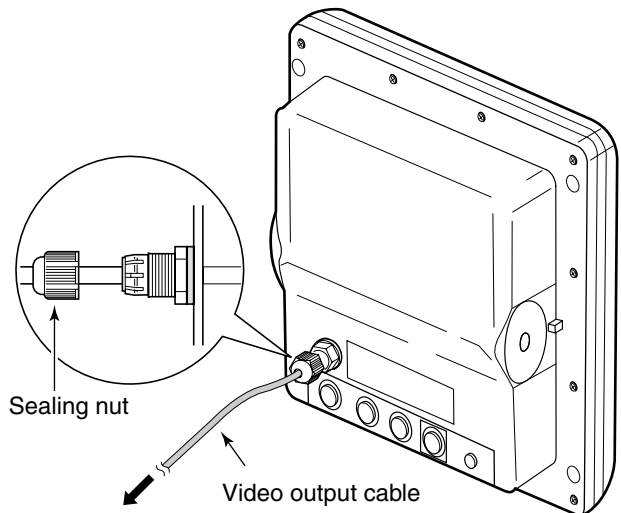

Fig. 6

■ Checking the installation

Before turning ON the power, be sure that the display unit and the scanner unit are installed correctly. The checklist below may help you.

Installation checklist

- The four bolts securing the scanner unit must be firmly tightened.
- Cabling must be securely attached to a mast or mounting material, and must not interfere with the rigging.
- Be sure waterproofing procedures are completed on the system cable.
- The power connections to the battery must be of the correct polarity.
- Be sure that the plugs at the rear of the display unit have been connected correctly and securely.

INDEX

A		I		P	
Accessories, supplied.....	i	Information box.....	4	Panel description.....	1
ACQ key.....	2	Installation.....	54	Parallel index lines.....	5, 17
AIS.....	26	Connectors.....	54	PI key.....	2
Icons.....	27	Display unit.....	55	Popup message.....	6
Operation.....	26	Scanner unit.....	57	Power.....	7
Settings.....	29	Video output unit.....	59	ON or OFF.....	1
Alarm.....	21	IR key.....	10	POWER KEY.....	1
ALARM key.....	2			Power save function.....	13
Alarm type.....	22	K		Power source.....	54
Alarm zone.....	21	Key backlight.....	8	Precautions.....	iii
Antenna.....		Keypad.....	1	Pulse Width.....	11
Antenna rotation speed.....	35				
Mounting.....	57	L		R	
Specification.....	52	Language.....	34	RAIN.....	9
ARPA.....		Long pulse.....	11	Range ring.....	
Operation.....	23			Brilliance.....	8
Settings.....	25	M		Selecting.....	17
Targets.....	24	Maintenance.....	50	Range selection.....	37
		Measurement.....	17	Receiving.....	
		Bearing and distance.....	18	AIS.....	26
		Between two targets.....	19	DSC.....	32
		Distance.....	17	Resetting.....	38
		From a waypoint.....	20		
		Relative speed.....	19	S	
		MENU list.....	65	Screen.....	3
		MENU screen.....	40	SEA.....	9
		AIS.....	42	Settings.....	
		AIS Own.....	46	Saving and loading.....	37
		ARPA.....	41	Ship speed.....	14
		Display.....	40	Simulation mode.....	34
		Initial.....	45	Specifications.....	52
		Operation.....	39		
		Port Monitor.....	46	T	
		Scanner Monitor.....	46	TLL.....	33
		Status.....	46	Trail.....	12
		System.....	44		
		Target.....	41	U	
		Trail.....	40	UX-252.....	59
		Video.....	43		
		MODE key.....	3	V	
				VRM.....	2, 18
		O		W	
		OFF CENTER.....	10	Warning message.....	6
		Operating guide.....	64	Waypoint.....	14
		Options.....	52	Marker.....	5
		G		Z	
GAIN.....	9			ZOOM key.....	1, 10
GPS.....	15, 53				
		H			
Heading adjustment.....	36				
Heading marker.....	9				
HL-OFF key.....	2				

Cut here

Display mounting bracket template

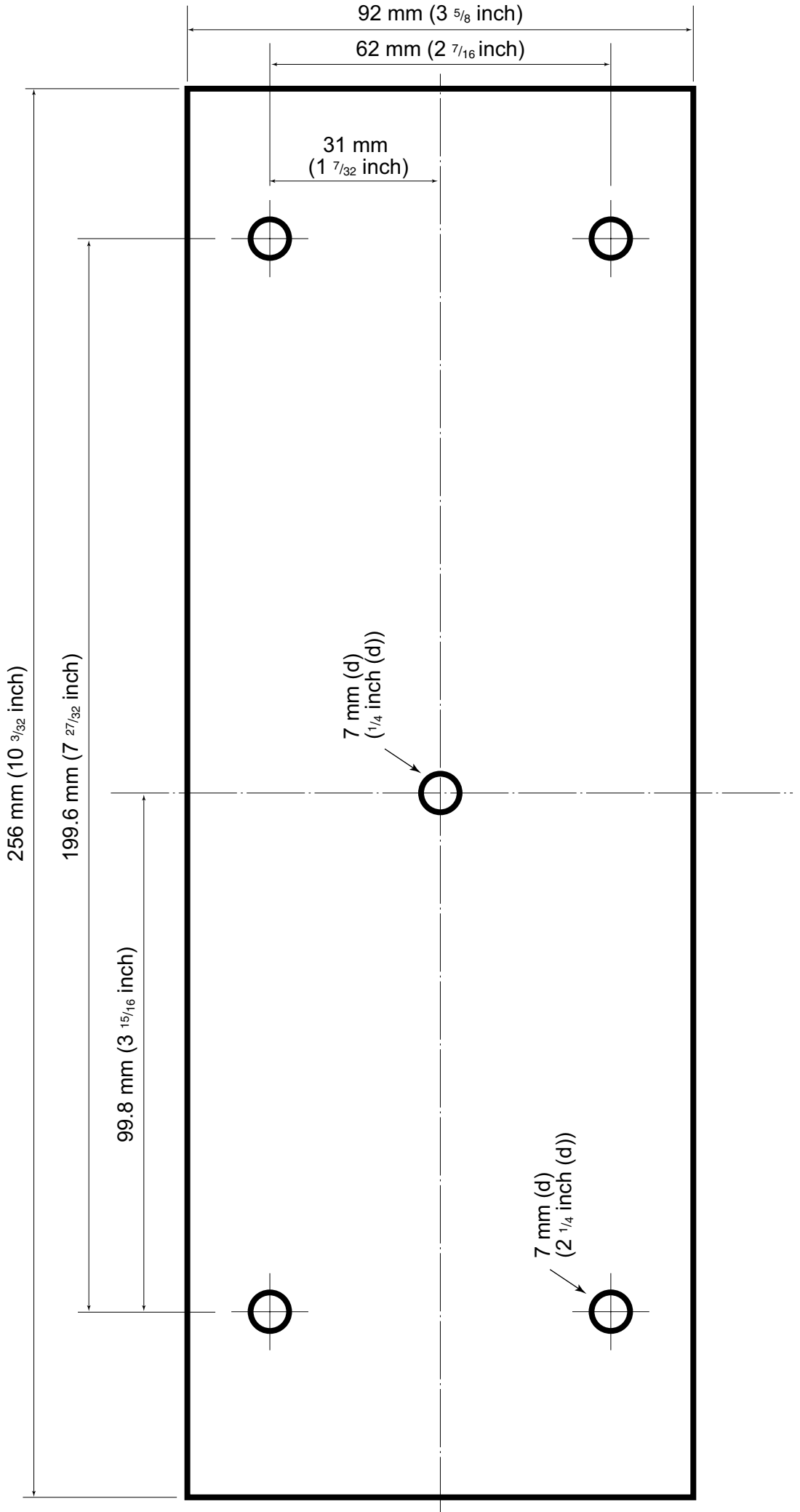

Refer to the Instruction Manual for details about the ARPA, the AIS receiver, and DSC functions,

■ Display information

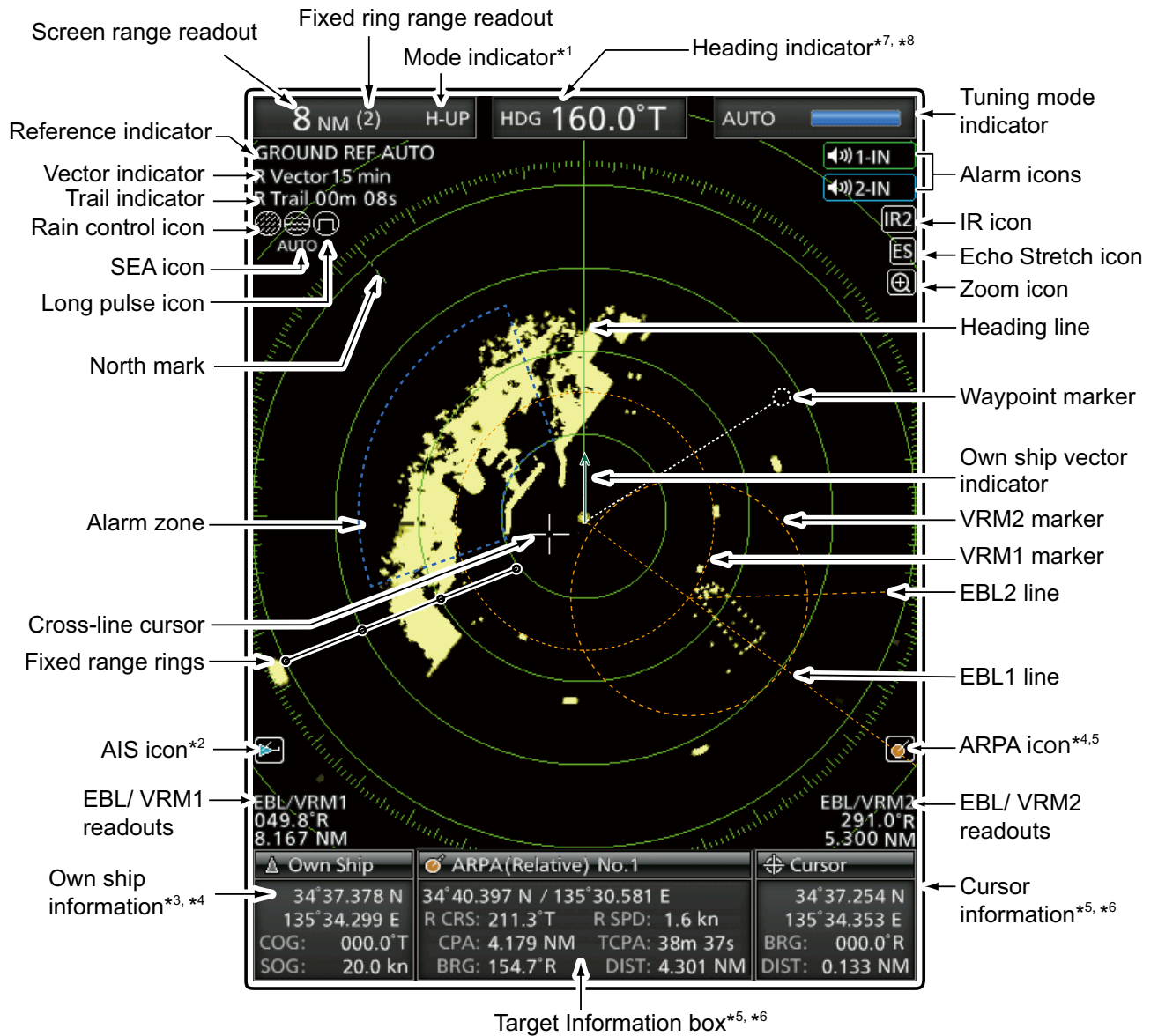

*1 North-up and Course-up screens can be used only when a bearing input (NMEA, N+1 or AUX) is connected.

*2 AIS data is required.

*3 Your position data is required.

*4 GPS data is required.

COG (Course Over Ground), SOG (Speed Over Ground)

*5 Bearing data and position data are required.

*6 R: Relative bearing, T: True bearing, M: Magnetic bearing

*7 T: True bearing, M: Magnetic bearing

*8 COG (Course Over Ground) is displayed when the "Bearing Input" item in the Initial menu is set to "GPS" or "GPS-L."

When using COG instead of HDG, the heading indicator may differ from the vessel's actual bow direction.

■ MENU screen operation

1 Push / to enter the Menu screen.

2 Push to select the menu.

3 Push to select an item.

4 Push to enter the option selection mode.

5 Push to select an option.

6 Push to save the setting and exit the option selection mode.

7 Push / to exit the Menu screen.

■ MENU list

<p>Color</p> <ul style="list-style-type: none"> Echo Color Steps Heading Line Brill Ring Brill ARPA/AIS Brill EBL/VRM/PI Brill Other symbol Brill Character Brill Day Color Setting Night Color Setting User Color Setting 	<p>Target</p> <ul style="list-style-type: none"> Vector Mode Vector Time Track Interval CPA Limit TCPA Limit CPA/TCPA Alarm 	<p>System</p> <ul style="list-style-type: none"> Key Beep Sync Backlight HL OFF Mode Zone Alarm 1/2 Zone Alarm Level OFF Center Mode Save Time Bearing Mode Variation Manual Variation Bearing Reference Speed Input Manual Speed Manual SET Manual Drift TLL Mode STBY Mode Rev. 	<p>Initial</p> <ul style="list-style-type: none"> Distance Unit Speed Unit Date Display Language Bearing Input TX Inhibit TX Inhibit Start TX Inhibit Angle Timing Adjust Heading Adjust Antenna Rotation Speed Range Ring Range Save Settings 1/2/3 Load Settings 1/2/3 Setting Reset Factory Reset
<p>Trail</p> <ul style="list-style-type: none"> Reset Reference Time Color Level 	<p>ARPA</p> <ul style="list-style-type: none"> Function Auto Acquire Track No. Display All Clear Target 	<p>Video</p> <ul style="list-style-type: none"> TUNE Manual Tune Dynamic Range IR Echo Stretch Pulse Width SEA Curve Antenna Height 	<p>AIS Own</p>
<p>Display</p> <ul style="list-style-type: none"> Own Vector PPI Area AUTO Hide Information WPT Display Mark Display DSC Display Cursor Information 	<p>AIS</p> <ul style="list-style-type: none"> Display Track Name Display Auto Activate Auto Activate - Distance Auto Activate - Angle New Target Warning Display Range Number of AIS Slow Warn Slow Warn Speed Erase Lost Target Safety Message Favorite AIS Favorite AIS Range Favorite AIS Target 1/2/3 	<p>Status</p>	<p>Port Monitor</p> <ul style="list-style-type: none"> NMEA1 RX NMEA2 RX NMEA2 TX AIS RX DSC RX
			<p>Scanner Monitor</p>

FCC INFORMATION

This equipment has been tested and found to comply with the limits for a Class B digital device, pursuant to part 15 of the FCC Rules. These limits are designed to provide reasonable protection against harmful interference in a residential installation. This equipment generates, uses and can radiate radio frequency energy and, if not installed and used in accordance with the instructions, may cause harmful interference to radio communications. However, there is no guarantee that interference will not occur in a particular installation. If this equipment does cause harmful interference to radio or television reception, which can be determined by turning the equipment off and on, the user is encouraged to try to correct the interference by one or more of the following measures:

- Reorient or relocate the receiving antenna.
- Increase the separation between the equipment and receiver.
- Connect the equipment into an outlet on a circuit different from that to which the receiver is connected.
- Consult the dealer or an experienced radio/TV technician for help.

CAUTION: Changes or modifications to this device, not expressly approved by Icom Inc., could void your authority to operate this device under FCC regulations.

FOR CANADA:

This device contains licence-exempt transmitter(s)/ receiver(s) that comply with Innovation, Science and Economic Development Canada's licence-exempt RSS(s). Operation is subject to the following two conditions:

1. This device may not cause interference.
2. This device must accept any interference, including interference that may cause undesired operation of the device.

RADAR OPERATOR WARNING



Icom requires the radar operator to meet the FCC and IC Requirements for Radio Frequency Exposure. A slotted waveguide array antenna with gain not greater than 27 dBi must be mounted a minimum of 5.5 meters (measured from the lowest point of the antenna) vertically above the main deck and all possible personnel. This is the minimum safe separation distance estimated to meet all RF exposure compliance requirements. This 5.5 meter distance is based on the FCC and IC Safe Maximum Permissible Exposure (MPE) distance of 3.5 meters added to the height of an adult (2 meters) and is appropriate for all vessels.

For watercraft without suitable structures, the antenna must be mounted so as to maintain a minimum of 1 meter vertically between the antenna, (measured from the lowest point of the antenna), to the heads of all persons AND all persons must stay outside of the 3.5 meter MPE radius.

Do not transmit with radar and antenna when persons are within the MPE radius of the antenna, unless such persons (such as driver or radar operator) are shielded from antenna field by a grounded metallic barrier. The MPE Radius is the minimum distance from the antenna axis that person should maintain in order to avoid RF exposure higher than the allowable MPE level set by FCC and IC.

FAILURE TO OBSERVE THESE LIMITS MAY ALLOW THOSE WITHIN THE MPE RADIUS TO EXPERIENCE RF RADIATION ABSORPTION WHICH EXCEEDS THE MAXIMUM PERMISSIBLE EXPOSURE (MPE) LIMIT.

IT IS THE RESPONSIBILITY OF THE RADAR OPERATOR TO ENSURE THAT THE MAXIMUM PERMISSIBLE EXPOSURE LIMITS ARE OBSERVED AT ALL TIMES DURING RADAR TRANSMISSION. THE RADAR OPERATOR IS TO ENSURE THAT NO BYSTANDERS COME WITHIN THE RADIUS OF THE MAXIMUM PERMISSIBLE EXPOSURE LIMITS.

Determining MPE Radius

THE MAXIMUM PERMISSIBLE EXPOSURE (MPE) RADIUS HAS BEEN ESTIMATED TO BE A RADIUS OF ABOUT 3.5 M PER OET BULLETIN 65 OF THE FCC.

THIS ESTIMATE IS MADE ASSUMING THE MAXIMUM POWER OF THE RADAR AND ANTENNAS WITH A MAXIMUM GAIN OF 27 dBi ARE USED FOR A SHIP MOUNTED SYSTEM.

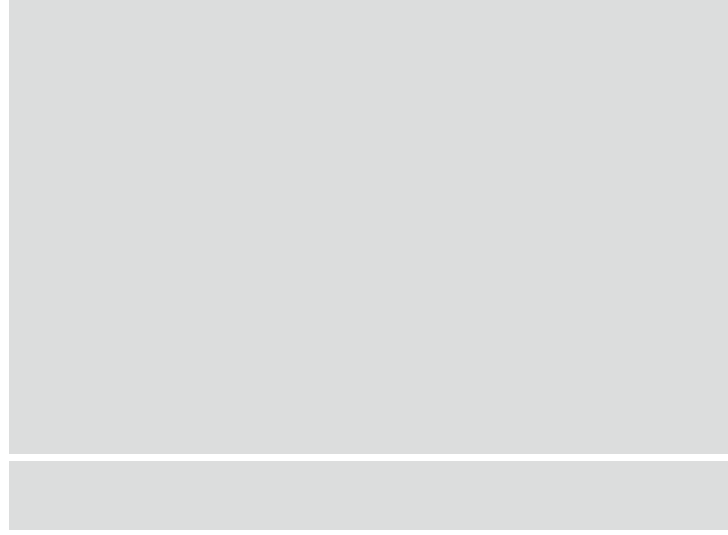

● Display unit
template

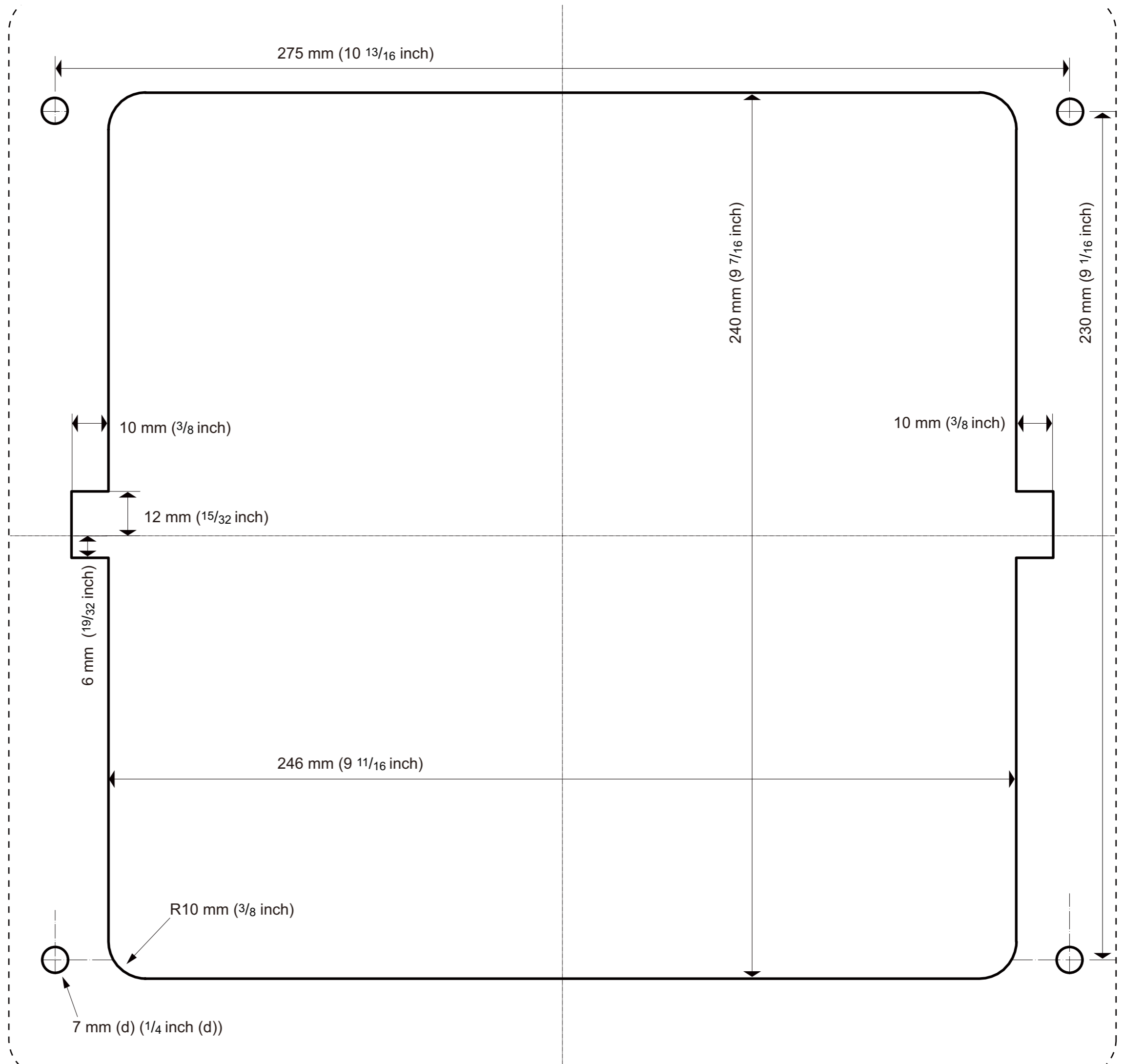

• **Scanner unit
(Radome type)
template**

