INTRODUCTION

Thank you for choosing this Icom product. This product is designed and built with Icom's state of the art technology and craftsmanship. With proper care, this product should provide you with years of trouble-free operation.

IMPORTANT

FIRST, CAREFULLY READ INSTRUCTIONS that is boxed with the transceiver.

SAVE THIS GUIDE— This guide contains additional important operating instructions for the transceiver.

Icom and the Icom logo are registered trademarks of Icom Incorporated (Japan) in Japan, the United States, the United Kingdom, Germany, France, Spain, Russia, Australia, New Zealand, and/or other countries.
NXDN is a trademark of Icom Incorporated and JVC KENWOOD Corporation.
All other products or brands are registered trademarks or trademarks of their respective holders.

Icom is not responsible for the destruction, damage to, or performance of any Icom or non-Icom equipment, if the malfunction is because of:

- Force majeure, including, but not limited to, fires, earthquakes, storms, floods, lightning, other natural disasters, disturbances, riots, war, or radioactive contamination.
- The use of Icom transceivers with any equipment that is not manufactured or approved by Icom.

Section 1 ACCESSORIES

Supplied accessories.....	1-2
Rear panel connections.....	1-3
◇ Grounding.....	1-3
Mounting the transceiver	1-4

Supplied accessories

Microphone

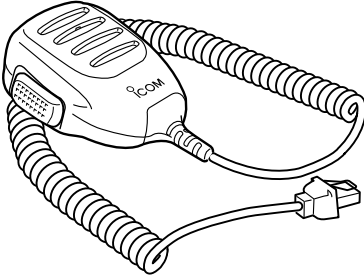

Microphone hanger and screws (3×16 mm)

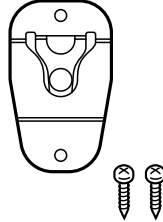

Microphone hanger cable

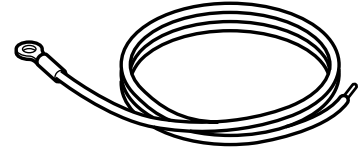

Mounting bracket

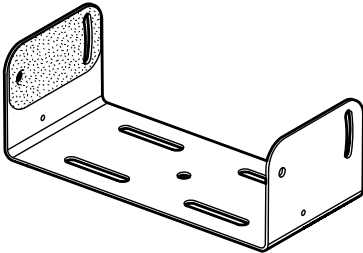

DC power cable

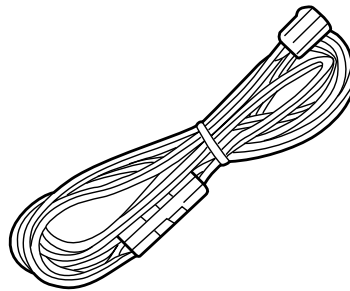

Bracket bolts (M4×8 mm)



Mounting screws (M5×12 mm)

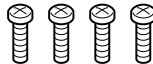

Self-tapping screws (5×20 mm)

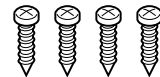

Flat washers (M5)



Spring washers (M5)



Nuts (M5)



NOTE: Some accessories are not supplied, or the shape is different, depending on the transceiver version.

Rear panel connections

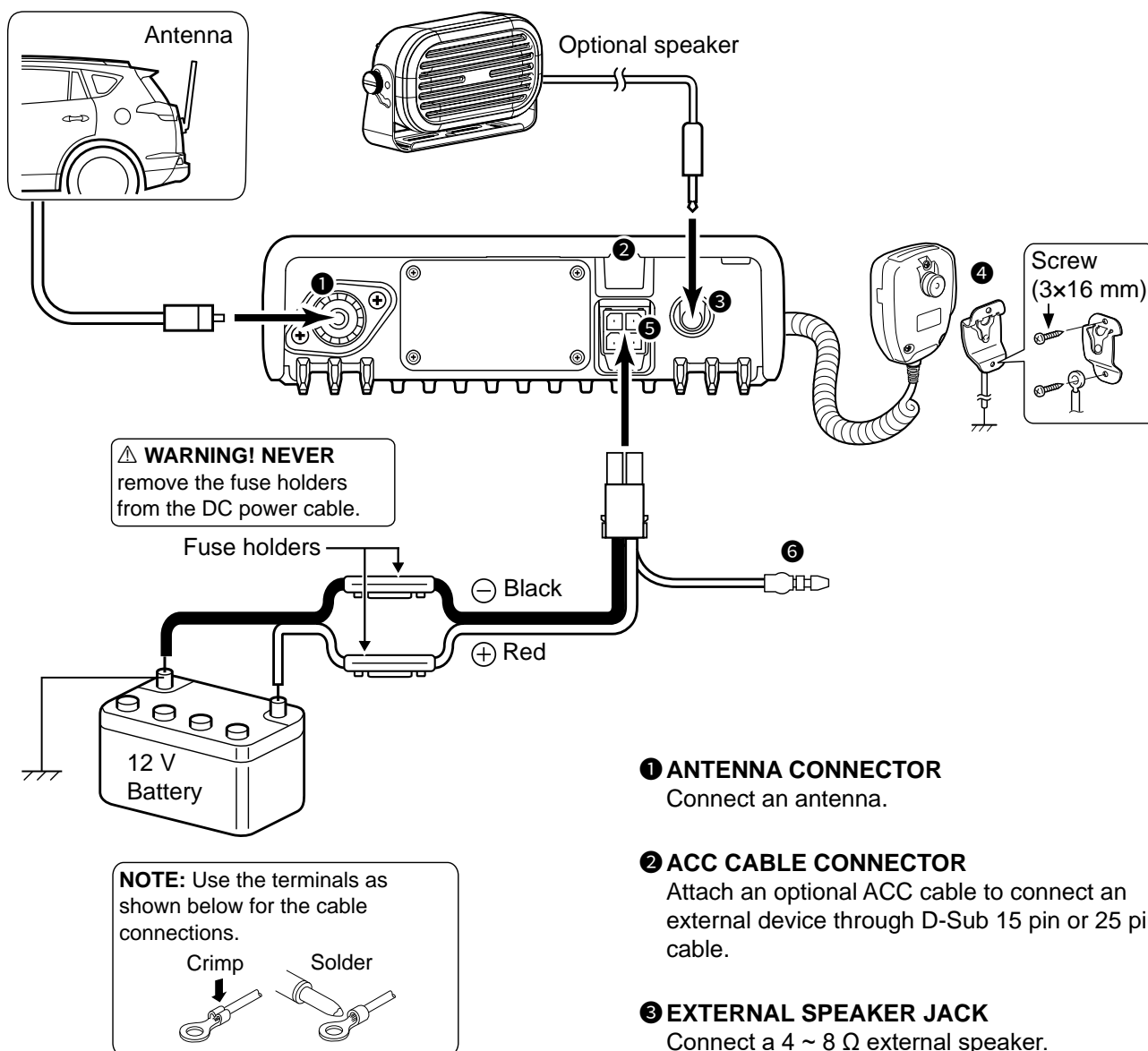

1 ANTENNA CONNECTOR

Connect an antenna.

2 ACC CABLE CONNECTOR

Attach an optional ACC cable to connect an external device through D-Sub 15 pin or 25 pin cable.

3 EXTERNAL SPEAKER JACK

Connect a 4 ~ 8 Ω external speaker.

4 MICROPHONE HANGER

Connect the supplied microphone hanger to the vehicle's ground for microphone ON/OFF hook functions.

5 DC POWER CONNECTOR

Connect a 12 V DC battery. Pay attention to polarities.

CAUTION: DO NOT connect to a 24 V battery. This will damage the transceiver.

6 IGNITION LEAD

Connects to an ignition line.

Mounting the transceiver

Mount the transceiver on a flat surface using the mounting bracket supplied with your transceiver.

1. Drill 4 holes on a flat surface where you want to install the mounting bracket.
 - ① When using the supplied nuts: Approximately 5.5 ~ 6 mm (d)
 - ① When using the supplied self-tapping screws: Approximately 2 ~ 3 mm (d)
2. Attach the mounting bracket on the flat surface using the supplied screws, nuts, and washers.
3. Attach the transceiver to the mounting bracket using the supplied bracket bolts.

Mounting example:

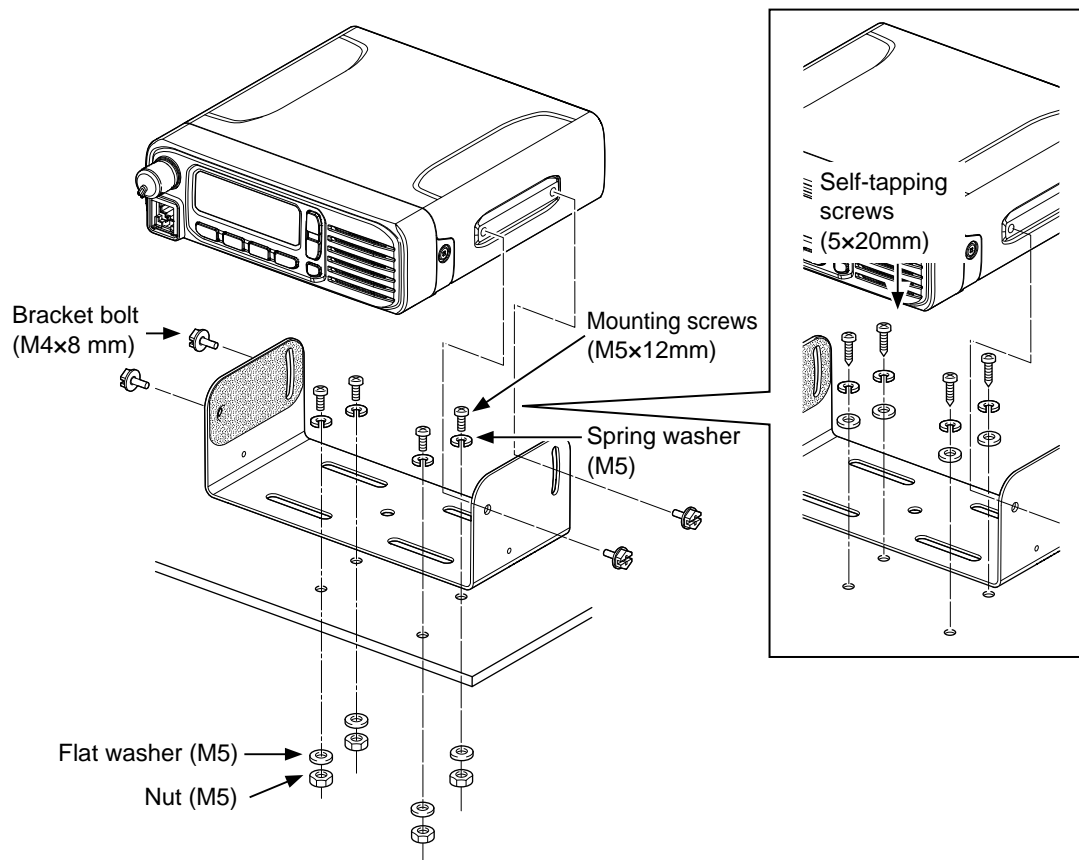

Section 2

PANEL DESCRIPTION

Front panel	2-2
◇ Main unit	2-2
Function display.....	2-3
Assignable key functions	2-4
◇ Category: –	2-6
◇ Category: Channel/Scan.....	2-6
◇ Category: Signaling/Call	2-7
◇ Category: Functions.....	2-9
◇ Category: GPS.....	2-9

Front panel

◇ Main unit

*Assign the functions to the Assignable keys using the CS-F5130D PROGRAMMING SOFTWARE.
(User Interface > **Key Settings**)

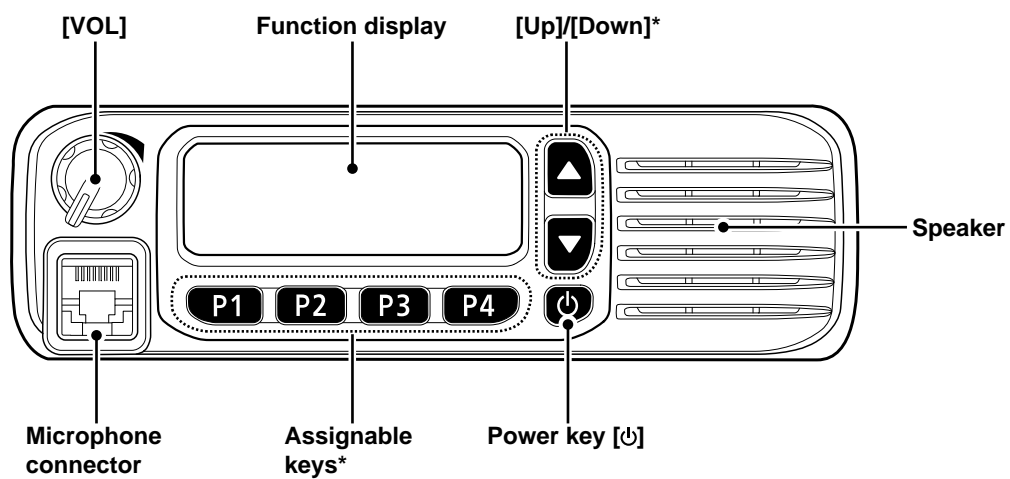

Function display

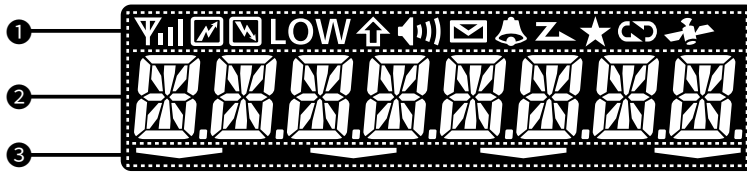

1 ICON AREA

Displays the icons, as shown below.

	Displays the relative receive signal strength level.
	Displayed while transmitting a signal.
	Displayed while the channel is busy (receiving).
LOW	Displayed when the low output power is selected.
	Displayed when the Shift function is ON. The user can use a Assignable key's secondary function in the Shift mode.
	Displayed when the channel is in the audible (unmuted) mode.
	Blinks after messages (Message or Status Message) have been received.
	Displayed when a matching signal is received, depending on the presetting.
	<ul style="list-style-type: none"> Blinks while scanning. Displayed when a scan is paused.
	Displayed when the channel is selected as a scan target channel.

	<ul style="list-style-type: none"> Displayed when the Encryption function is ON. Blinks when decoding an encrypted signal.
	<ul style="list-style-type: none"> Displayed when valid position data is received. Blinks when searching for satellites.

2 ALPHANUMERIC READOUT

Displays messages such as channel text.

3 DEALER ASSIGNABLE KEY ICONS

Displayed while the function assigned to [P1], [P2], [P3], or [P4] is operating. Assign the functions using the CS-F5130D PROGRAMMING SOFTWARE. (User Interface > **Key Settings**)

① Icons are displayed if the following functions are assigned and operating.

- Shift (p. 2-6)
- Scan Start/Stop (p. 2-7)
- Scan Add/Del (Tag) (p. 2-7)
- Talk Around (p. 2-7)
- Digital Button (p. 2-8)
- Group (p. 2-8)
- Individual (p. 2-8)
- Lock (p. 2-9)
- Lone Worker (p. 2-9)

Assignable key functions

Assign the functions to the Assignable keys on the front panel using the CS-F5130D PROGRAMMING SOFTWARE.
(User Interface > **Key Settings**)

Category	Assignable function	Reference	Digital (NXDN)		Analog			
			Conventional	Single-site Trunk	2-Tone	5-Tone	MDC	BIIS
-	Null	p. 2-6	✓	✓	✓	✓	✓	✓
	Home	p. 2-6	✓	✓	✓	✓	✓	✓
	Shift	p. 2-6	✓	✓	✓	✓	✓	✓
Channel / Scan	Bandwidth	p. 2-6	N/A	N/A	✓	✓	✓	✓
	CH Up, CH Down	p. 2-6	✓	✓	✓	✓	✓	✓
	C.Tone CH Select	p. 2-6	N/A	N/A	✓	✓	✓	✓
	Encryption	p. 2-6	✓	✓	N/A	N/A	N/A	N/A
	High/Low	p. 2-6	✓	✓	✓	✓	✓	✓
	Monitor	p. 2-6	✓	N/A	✓	✓	✓	✓
	MR-CH1/2/3/4	p. 2-6	✓	✓	✓	✓	✓	✓
	Prio A, Prio B	p. 2-7	✓	✓	✓	✓	✓	✓
	Prio A (Rewrite), Prio B (Rewrite)	p. 2-7	✓	✓	✓	✓	✓	✓
	Scan Start/Stop	p. 2-7	✓	✓	✓	✓	✓	✓
	Scan Add/Del (Tag)	p. 2-7	✓	✓	✓	✓	✓	✓
	Talk Around	p. 2-7	✓	✓	✓	✓	✓	✓
	Tone/RAN CH Select	p. 2-7	✓	N/A	✓	✓	✓	✓
	Zone Select	p. 2-7	✓	✓	✓	✓	✓	✓
Zone Up, Zone Down	p. 2-7	✓	✓	✓	✓	✓	✓	
Signaling / Call	Call	p. 2-7	N/A	N/A	✓	✓	N/A	N/A
	Call A, Call B	p. 2-7	N/A	N/A	✓	✓	N/A	N/A
	Call Alert	p. 2-7	✓	✓	N/A	N/A	N/A	N/A
	Call List Select	p. 2-8	✓	✓	✓	✓	N/A	N/A
	Call List Up, Call List Down	p. 2-8	✓	✓	✓	✓	N/A	N/A
	Digital Button	p. 2-8	✓	✓	N/A	N/A	N/A	N/A
	DTMF Autodial	p. 2-8	✓	✓	✓	✓	✓	✓
	Emergency	p. 2-8	✓	✓	✓	✓	✓	✓
	Power OFF Emergency	p. 2-8	✓	✓	✓	✓	✓	✓
	Group	p. 2-8	✓	✓	✓	✓	N/A	N/A
	Individual	p. 2-8	✓	✓	✓	✓	N/A	N/A
	ID-MR Select	p. 2-8	N/A	N/A	N/A	✓	N/A	N/A

✓: Applicable
N/A: Not Applicable

2 PANEL DESCRIPTION

Assignable key functions (Continued)

Category	Assignable function	Reference	Digital (NXDN)		Analog			
			Conventional	Single-site Trunk	2-Tone	5-Tone	MDC	BIIS
Signaling / Call	Message	p. 2-8	✓	✓	N/A	N/A	N/A	N/A
	Re-dial	p. 2-8	✓	✓	✓	✓	✓	✓
	Status	p. 2-8	✓	✓	N/A	N/A	N/A	N/A
	Status Up, Status Down	p. 2-8	✓	✓	N/A	N/A	N/A	N/A
	TX Code Enter	p. 2-8	N/A	N/A	N/A	✓	N/A	N/A
Functions	Ext. CH Sel Mode	p. 2-9	✓	✓	✓	✓	✓	✓
	Light	p. 2-9	✓	✓	✓	✓	✓	✓
	Lock	p. 2-9	✓	✓	✓	✓	✓	✓
	Lone Worker	p. 2-9	✓	✓	✓	✓	✓	✓
	Sp. Func 1/2	p. 2-9	✓	✓	✓	✓	✓	✓
	Hook Scan	p. 2-9	✓	✓	✓	✓	✓	✓
	Horn	p. 2-9	✓	✓	✓	✓	✓	✓
	User Set Mode	p. 2-9	✓	✓	✓	✓	✓	✓
	VOX	p. 2-9	✓	✓	✓	✓	✓	✓
GPS	GPS Display	p. 2-9	✓	✓	✓	✓	✓	✓

✓: Applicable

N/A: Not Applicable

Assignable key functions (Continued)

◇ Category: –

Null

No function.

Home

In the Analog mode

- Push to reset the destination station code to the default, if it has been manually changed.
- While in the Audible mode, push to return to the Inaudible mode, and automatically sends a reset code.

In the Digital mode

- Push to reset the destination Unit ID and call type to the default, if they have been manually changed.
- Push to cancel the Talk Back function, if it is activated.

Shift

1. Push to enter the Shift mode.
 - “” is displayed.
 - ① A user can use a Dealer Assignable Key's secondary function in the Shift mode.
2. Push this key again to return to the Normal mode.

◇ Category: Channel/Scan

Bandwidth

Push to temporarily set the bandwidth to Wide* or Narrow.

① The wide bandwidth can be preset to either 25.0 kHz (Wide) or 20.0 kHz (Mid).

Depending on the presetting, Mid may be selectable.

* The Wide bandwidth is not usable in the USA version transceivers.

CH Up, CH Down

- Push to select an operating channel.
- After pushing a Software Key, push to select an option, setting, and so on.

C.Tone CH Select

Push to display the Continuous Tone Channel selection mode. Then push [CH Up] or [CH Down] to select a tone frequency or code. After selecting, push this key again to save.

Encryption

Push to turn the Encryption function ON or OFF.

① The Voice or Data Encryption function provides private communication between stations by using an Encryption Key and Key ID.

High/Low

Push to select the transmit output power level temporarily or permanently, depending on the presetting.

Monitor

- Hold down to unmute the channel. (Audible mode)
- Push to enter the Inaudible mode.
- Activates the following function on each channel, depending on the presetting.
 - ① After the communication is finished, push to send a 'reset code' (5-Tone).
- Depending on the presetting, hold down for 1 second to cancel a scan.

NOTE: The audible (unmuted) mode may automatically return to the Inaudible (muted) mode, after the preset time period ends.

MR-CH 1, MR-CH 2, MR-CH 3, MR-CH, 4

Push to directly select the Memory channel 1, 2, 3, or 4.

Assignable key functions (Continued)

Prio A, Prio B

Push to select the Priority A or Priority B channel.

Prio A (Rewrite), Prio B (Rewrite)

- Push to select the Priority A or Priority B channel.
- Hold down for 1 second to assign the operating channel to the Priority A or Priority B channel.

Scan Start/Stop

- Push to start or stop a Scan.
 - “Z” blinks while scanning.
 - ① When a scan starts with the Power ON Scan or Auto Scan function, pushing this key pauses the scan. The paused scan resumes after the preset time period has passed.
- Hold down for 1 second to enter the Scan list selection mode, and then push [CH Up] or [CH Down] to select a Scan list.

NOTE: When Mode Dependent Scan is ON, a user may not be able to display the Scan list, depending on the presetting. Set the related settings using the CS-F5130D PROGRAMMING SOFTWARE.
(Scan > **Scan Settings**)

Scan Add/Del (Tag)

- Push to add a channel to, or delete it from a selected Scan list.
 1. Hold down for 1 second to enter the Scan list selection mode, and then push [CH Up] or [CH Down] to select a Scan list.
 2. Push this key to add a channel to, or delete it from the selected Scan list.
 - “★” is displayed for a tagged channel.
 3. Hold down this key to exit the Scan list selection mode.

NOTE: When the Nuisance Delete function is ON, the removed channel is automatically added to the Scan group again, after the Scan is canceled. Set the related settings using the CS-F5130D PROGRAMMING SOFTWARE.
(Scan > **Scan Settings**)

Talk Around

The Talk Around function equalizes the transmit frequency to the receive frequency, for direct (Simplex) communication.

- Push to turn the Talk Around function ON or OFF.

Tone/RAN CH Select

In the Analog mode

1. Push to enter the Continuous Tone channel selection mode, and then push [CH Up] or [CH Down] to select a tone frequency/code.
2. After selecting, push this key again to set.

In the Digital mode

1. Push to enter the RAN Channel selection mode, and then push [CH Up] or [CH Down] to select a RAN code.
2. After selecting, push this key again to set.

Zone Select

Push to enter the Zone selection mode, and then push [CH Up] or [CH Down] to select a zone.

TIP: What is a “Zone”?

Certain channels are grouped and assigned to a Zone according to their intended use. For example, Analog channels ‘Station 1’ and ‘Station 2’ are assigned to an “Analog” Zone, and Digital channels ‘Station 3’ and ‘Station 4’ are assigned to a “Digital” Zone.

Zone Up, Zone Down

Repeatedly push to select an operating zone without entering the Zone selection mode.

◇ Category: Signaling/Call

Call

Push to make a call to the preset destination in the channel.

Call A, Call B

Push to transmit a set 2-Tone or 5-Tone code.

- ① The code is transmitted to the selected station in Call Key Assign.

Call Alert (For only the Digital mode)

Hold down for 1 second to transmit a Call Alert. The Call Alert notifies you a call from another transceiver when you are away from your transceiver.

Assignable key functions (Continued)

Call List Select

1. Push to display the Call List selection mode.
2. Push [CH Up] or [CH Down] to select an ID name (or ID code).
3. After selecting, push this key again to set, and return to the Standby mode.

NOTE: On a 5-Tone channel, hold down to enter the 5-Tone TX Code Edit screen.

Call List Up, Call List Down

Repeatedly push to select an ID or code without entering the Call List selection mode.

Digital Button

- Push to enter the Application selection mode.
- Hold down for 1 second to select the call type between Individual (INDIV) and Group (GROUP), then automatically enter the Application selection mode.
- While in the Application selection mode, hold down for 1 second to return to the standby screen.

DTMF Autodial

1. Push to display the DTMF Code.
2. Select a DTMF code using [CH Up] or [CH Down].
3. Push this key again to transmit the DTMF code.

Emergency

1. Hold down during the Emer SW ON Timer (Sec) period to enter the Emergency mode.
 2. After the Reminder Timer period has passed, an Emergency call is automatically transmitted once, or repeatedly.
- ① Hold down during the Emer SW OFF Timer (Sec) period to cancel the Emergency function, before transmitting an Emergency call.

NOTE: Set the related settings using the CS-F5130D PROGRAMMING SOFTWARE to use the function. (Emergency > **Emergency Settings**)

Power OFF Emergency

While holding down this key, turn OFF the transceiver to activate the Power OFF Emergency function. The function enables the transceiver to transmit an emergency call, even though it appears to be powered OFF.

Group

1. Push to display the Group List selection mode.
2. Push [CH Up] or [CH Down] to select an ID name (or ID code).
3. After selecting, push this key again to set, and return to the Standby mode.

Individual

1. Push to display the Individual List selection mode.
2. Push [CH Up] or [CH Down] to select an ID name (or ID code).
3. After selecting, push this key again to set, and return to the Standby mode.

ID-MR Select

- Push to recall the received ID code. The transceiver can memorize up to 5 codes. Select one of them using [CH Up] or [CH Down].
- Hold down for 1 second to clear the selected ID code.

Message

1. While in the Standby mode, push to display the Message List screen.
2. Push [CH Up] or [CH Down] to select a message.
3. Push [PTT] to send the message to the currently selected station or group.

NOTE: Set the related settings using the CS-F5130D PROGRAMMING SOFTWARE to use the function. (Digital > Message > **Message List**)

Re-dial

Push to send the last transmitted DTMF code number.

- ① Redial will be cleared when the transceiver is turned OFF once.

Status

- Hold down for 1 second to transmit a Status call in the Standby mode.
- You can select a status message, as described below.

1. Push to display the Status Message selection screen, and then select a status message using [CH Up] or [CH Down].
2. Push [PTT] to transmit a Status call.

NOTE: Set the related settings using the CS-F5130D PROGRAMMING SOFTWARE to use the function. (Digital > Status > **Status List**)

Status Up, Status Down

While in the Standby mode, push to select a status message.

TX Code Enter

Push to enter the TX Code edit mode (5-Tone).

Assignable key functions (Continued)

◇ Category: Functions

Ext.CH Sel Mode

Push to turn the Ext. CH Select function ON or OFF. When this function is ON, Memory channels are selectable by only external entry.

NOTE:

- Set the related settings using the CS-F5130D PROGRAMMING SOFTWARE to use the function. (Common > External I/O > **Port Settings**)
- The function is activated when an external unit is connected to the transceiver.

Light

Push to turn ON the backlight for about 5 seconds, even if the backlight setting is OFF.

Lock

Hold down for 1 second to turn the Key Lock function ON or OFF.

- ① All keys except the following are electronically locked: [Monitor], [Call], [Call A], [Call B], [Emergency], [Light], [Lock], [Lone Worker], [Sp. Func 1] [Sp. Func 2], [Shift], [Power OFF Emergency], and [PTT].

Lone Worker

Push to turn the Lone Worker function ON or OFF.

- ① If no operation occurs during a specified period, the Lone Worker function automatically makes the transceiver enter the Emergency mode.

NOTE: Set the related settings using the CS-F5130D PROGRAMMING SOFTWARE to use the function. (Emergency > Emergency Settings > **Lone Worker**)

Sp. Func 1, Sp. Func 2

Sp. Func 1 and Sp. Func 2 are reserved for PC commands.

Hook Scan

Push to temporarily turn the Hook Scan function ON or OFF.

Horn

Push to turn the Horn function ON or OFF. When the Horn function is ON, the HORN terminal of the D-Sub 15 pin or 25 pin is activated after receiving a call when Dec EXO is ON. This function is useful when the user is away from the transceiver.

NOTE: This function is used when an external speaker is connected to the D-Sub 15 pin or 25 pin connector.

User Set Mode

- Hold down for 1 second to enter the User Set mode. The User Set mode is used to change settings without using a PC.
 - ① Hold down for 1 second again to exit the User Set mode.
- In the User Set mode, momentarily push this key to select an item, and then push [CH Up] or [CH Down] to change the value or setting.

VOX

Push to turn the VOX function ON or OFF. The function automatically switches between receive and transmit by detecting your voice.

NOTE: A headset is required to use the function.

◇ Category: GPS

GPS Display

Push to display the position information.

Section 3

BASIC OPERATION

Turning ON the transceiver	3-2
◇ Entering the password	3-2
Selecting a Zone.....	3-3
◇ Selecting a Zone	3-3
Selecting a channel	3-3
◇ Voting operation	3-3
◇ Automatic Scan operation.....	3-3
◇ Selecting the Priority A or B channel.....	3-3
◇ Selecting a Continuous tone channel	3-3
◇ Selecting a RAN channel.....	3-3
Call procedure	3-4
Receiving and transmitting	3-5
◇ Transmitting notes	3-5
◇ Sending a call to a destination	3-5

Turning ON the transceiver

- Hold down [⏻] for more than 1 second turn ON or OFF the transceiver.

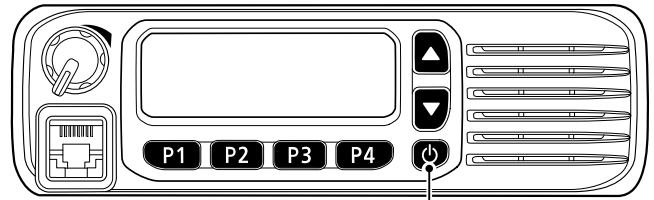

Power key [⏻]

◇ Entering the password

If the transceiver is preset for a Power ON Password, "PASSWORD" is displayed when turning ON the transceiver.



- Enter the preset password using the keys shown below.
The transceiver detects numbers in the same block as identical. Therefore "12345" and "67890" are the same.
 - After entering the correct password, the transceiver automatically enters the Standby mode.
 - ① If the transceiver does not display the Standby screen after entering the password, the entered code may be incorrect. Turn OFF the transceiver, and then turn it ON again and enter the correct code.

KEY	[P1]	[P2]	[P3]	[P4]	[Down]
NUMBER	1	2	3	4	5
	6	7	8	9	0

NOTE: Set the password related settings using the CS-F5130D PROGRAMMING SOFTWARE.
(Common > Security Settings > **Security**)

Selecting a Zone

Select from the Conventional, Multi-site Conventional, Single-site Trunking, or Voting Zone type.

Channels are grouped and assigned to a Zone according to their intended use.

For example, Analog channels 'Station 1' and 'Station 2' are assigned to an "Analog" Zone, and Digital channels 'Station 3' and 'Station 4' are assigned to a "Digital" Zone.

◇ Selecting a Zone

Example: The function [Zone Select] is assigned to the assignable key

1. Push [Zone Select] to enter the Zone Selection mode.
2. Push [CH Up] or [CH Down] to select a Zone.

Example: The function [Zone Up] and [Zone Down] are assigned to the assignable keys

- Repeatedly push [Zone Up] or [Zone Down] to select a Zone.

Selecting a channel

◇ Voting operation

The transceiver automatically starts scanning when a Zone specified for the Voting operation is selected. The Voting scan detects the signal strength of the repeaters, and automatically selects the strongest one.

◇ Automatic Scan operation

When you turn ON the transceiver, a scan may automatically start, depending on the presetting. If the scan starts, it will stop when a call is received.

◇ Selecting the Priority A or B channel

- ① Assign the function [Prio A (Rewrite)] or [Prio B (Rewrite)] to the assignable key.
- Push [Prio A (Rewrite)], or [Prio B (Rewrite)] to select the Priority A or Priority B channel.

◇ Selecting a Continuous tone channel

In the Analog mode

- ① Assign the function [C.Tone CH Select] to the assignable key.
1. Push [C.Tone CH Select] to enter the Continuous Tone Channel selection mode.
2. Push [CH Up] or [CH Down] to select a tone frequency/code.

◇ Selecting a RAN channel

In the Digital mode

- ① Assign the function [Tone/RAN CH Select] to the assignable key.
1. While in Digital mode, push [Tone/RAN CH Select] to enter the RAN Channel selection mode.
2. Push [CH Up] or [CH Down] to select a RAN channel.

Call procedure

A Call procedure may be necessary before voice transmission when your system uses tone signaling (except CTCSS and DTCS). The employed tone signaling may be a selective calling system, which enables you to call only specific stations, and prevents unwanted stations from contacting you.

1. Select a channel according to your system operator's instructions.
① This may not be necessary, depending on the presetting.
2. Push [Call].
3. After transmitting, the remainder of your communication can be carried out in the normal way.

Selective calling

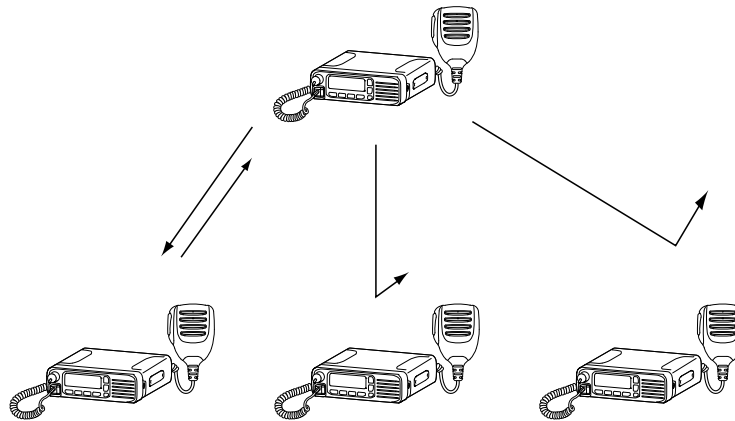

Non-selective calling

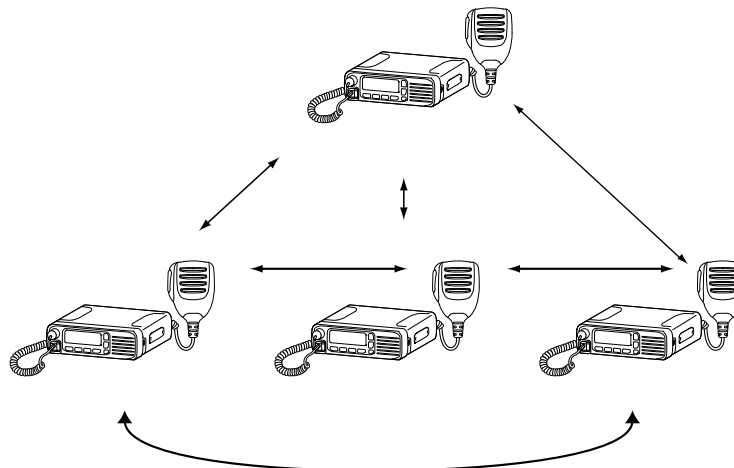

Receiving and transmitting

CAUTION: DO NOT transmit without an antenna.

Receiving:

1. Turn ON the transceiver. (p. 3-2)
2. Select a channel. (p. 3-3)
3. When receiving a call, rotate [VOL] to adjust the audio output level to a comfortable listening level.

NOTE: The transceiver may automatically transmit the microphone audio for the preset period when a matched signal is received, depending on the presetting. (Auto TX function)

Transmitting:

1. Wait for the channel to become clear to avoid interference.
2. While holding down [PTT], speak at your normal voice level.
 - ① The Call procedure may be necessary when a tone signaling system is used (p. 3-4).
3. Release [PTT] to receive.

IMPORTANT: To maximize the readability of your signal:

1. Pause briefly after pushing [PTT].
2. Hold the microphone 5 to 10 cm (2 to 4 inches) from your mouth, and then speak at your normal voice level.

◇ Transmitting notes

Transmit inhibit function

The transceiver has several inhibit functions that restrict transmission under the following conditions:

- The channel is in the Inaudible mode.
- The channel is busy. However, you can transmit when a call is received that includes a non-matching (or matching) CTCSS (DTCS), RAN (Radio Access Number), Individual ID, or Group ID, depending on the presetting.
- The selected channel is receive-only.

Time-Out Timer

If continuous transmission exceeds the preset Time-Out Timer time, the transmission is cut off.

Penalty timer

After the Time-Out Timer cuts off the transmission, the Penalty timer inhibits further transmission for a preset period of time.

◇ Sending a call to a destination

When a Tone frequency (2-Tone) or code (5-Tone) is preset in the Call List, you can select them as destination.

① Assign the function [Call List Select] to the assignable key.

1. Push [Call List Select] to enter the Call List selection mode.
2. Push [CH Up] or [CH Down] to select a Tone frequency or code.
 - The selected Tone frequency or code is briefly displayed and set.
3. Push [Call] to make a call to the selected destination.

Section 4

ADVANCED OPERATION

Emergency Call	4-2
◇ Making an Emergency call.....	4-2
◇ The Lone Worker function.....	4-3
DTMF calls	4-3
◇ DTMF Autodial	4-3
Radio Access Number (RAN).....	4-3
Scan	4-4
◇ Using the Scan function.....	4-4
◇ Scan Tag.....	4-4

Emergency Call

IMPORTANT: It is recommended that the dealer sets an Emergency channel in each Zone, to provide a reliable Emergency call operation.

NOTE: The following functions may be automatically activated, depending on the presetting.

Auto TX function

After an Emergency call is made, the transceiver transmits the microphone audio for a preset period of time.

Auto RX function

After an Emergency is made, the transceiver stands by in the Audible mode for a preset period of time.

◇ Making an Emergency call

When the transceiver enters the Emergency mode, a countdown starts. The transceiver counts down during the Reminder Timer set time.

Before the Reminder Timer set time expires, the transceiver transmits an Emergency call once, or repeatedly*, on the specified Emergency channel. If no Emergency channel is specified, the Emergency call is made on the previously selected channel.

* Depending on the presetting.

- ① The transceiver automatically transmits a repeat Emergency call until it receives an acknowledgment, or until a user turns OFF the transceiver.
- ① If the transceiver is set for the Silent operation, it transmits an Emergency call without a beep sounding.

The transceiver enters the Emergency mode through the following functions.

• **The [Emergency] key**

When a user holds down [Emergency] for the Emer SW ON Timer preset time.

- ① If a user holds down [Emergency] for the Emer SW OFF Timer set time before the Reminder Timer expires, the Emergency mode is canceled.

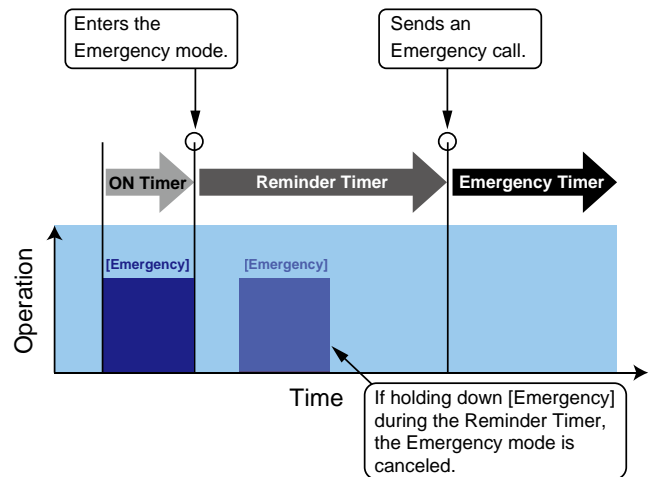

Emergency Call (Continued)

The transceiver enters the Emergency mode through the following functions, depending on a presetting.

◇ The Lone Worker function

When no operation occurs for the ON Timer preset time.

- ① If a user pushes any key before the Reminder Timer set time expires, the Emergency mode is canceled.

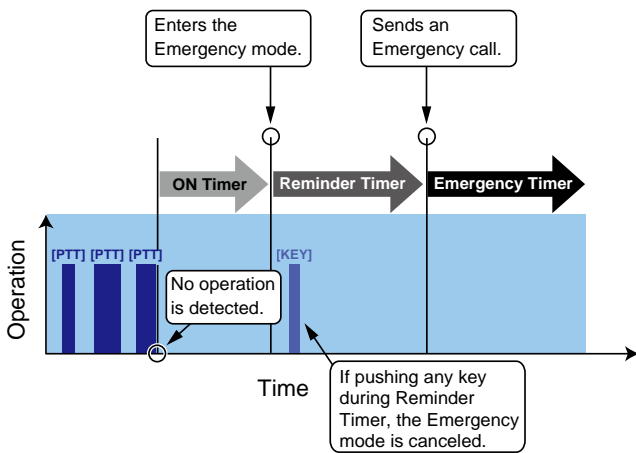

DTMF calls

◇ DTMF Autodial

A user can quickly send DTMF tones that have been pre-entered into the transceiver.

- ① Assign the function [DTMF Autodial] to the assignable key.
1. Push [CH Up] or [CH Down] to select a channel.
 2. Push [DTMF Autodial] to enter the DTMF Autodial List selection mode.
 3. Push [CH Up] or [CH Down] to select a DTMF Memory, and then push [DTMF Autodial] to send the DTMF code.
 - After sending, automatically returns to the standby screen.

Radio Access Number (RAN)

Radio Access Number (RAN) is a signaling system designed for digital radio communications. When a channel is set up with a RAN, the squelch will open only when a call containing a matching RAN is received. If a call containing a different RAN is made on the same channel a user is using, a user will not hear the call.

Scan

The Scan function is used to search signals on each channel. It stops when a signal is received.

- ① Assign the function [Scan Start/Stop] to the assignable key.
- ① Two or more channels must be preset to start a Scan.

◇ Using the Scan function

1. Selecting a Scan list

Select a Scan list to be scanned.

1. Hold down [Scan Start/Stop] for 1 second to enter the Scan list selection mode.
2. Push [CH Up] or [CH Down] to select a Scan list.
3. Push [Scan Start/Stop] to exit the Scan list selection mode.

NOTE: When Mode Dependent Scan is ON, a user may not be able to display the Scan list, depending on the presetting. Set the related settings using the CS-F5130D PROGRAMMING SOFTWARE.
(Scan > **Scan Settings**)

2. Starting/Stopping a Scan

- Push [Scan Start/Stop] to start or stop a scan.
 - “” blinks while scanning.
 - ① When a scan starts with the Power ON Scan or Auto Scan function, pushing this key pauses the scan. The paused scan resumes after the preset time period has passed.

◇ Scan Tag

You can add a channel to, or delete it from the Scan list. The Tagged channel is a target channel during a Scan.

- ① Assign the function [Scan Add/Del (Tag)] to the assignable key.

1. Push [CH Up] or [CH Down] to select a channel.
2. Hold down [Scan Add/Del (Tag)] for 1 second to enter the Scan list selection mode, and then push [CH Up] or [CH Down] to select a Scan list.
3. Push [Scan Add/Del (Tag)] to add a channel to, or delete it from the selected Scan list.
 - “” is displayed for a tagged channel.
4. Hold down [Scan Add/Del (Tag)] to exit the Scan group selection mode.

NOTE: When the Nuisance Delete function is ON, the removed channel is automatically added to the Scan group again, after the Scan is canceled. Set the related settings using the CS-F5130D PROGRAMMING SOFTWARE.
(Scan > **Scan Settings**)

Section 5 USER SET MODE

Using the User Set Mode	5-2
User Set Mode items	5-3

Using the User Set Mode

You can use the User Set Mode to set infrequently changed values or function settings.

① You cannot transmit or receive while the transceiver is in the User Set Mode.

Example: Disabling the key touch beep.

① Assign the function [User Set Mode] to the assignable key.

1. Hold down [User Set Mode] for 1 second to enter the User Set Mode.
 - A User Set Mode item is displayed.



2. Repeatedly push [User Set Mode] to select "BEEP."



3. Push [Up] or [Down] to select "OFF."



4. Hold down [User Set Mode] to exit and return to the Standby screen.

User Set Mode items

The usable items may differ, depending on the presetting on the CS-F5130D PROGRAMMING SOFTWARE. (User Interface > **Set Mode**)

Backlight

Sets the Backlight status.

- ON: The Backlight turns ON all the time.
- DIM: The Backlight lights dimly.
- DMA (Dim Auto): The Backlight lights dimly when a signal is applied to the external DIM terminal. It turns ON when no signal is applied to the external DIM terminal.
- AUT (OFF Auto): When pushing any key (except [PTT]), the backlight automatically turns ON for 5 seconds.
- OFF: Turns OFF the backlight.

Beep

Turns the key-touch beeps ON or OFF.

Beep level

Sets a beep and announces output level. When selecting a Linked option, the beep level is adjustable using [Up] and [Down].

- Range: 1 ~ 5, or 1 (Linked) ~ 5 (Linked)

Ringer level

Sets a ringer output level. When selecting a Linked option, the ringer level is adjustable using [Up] and [Down].

- Range: 1 ~ 5, or 1 (Linked) ~ 5 (Linked)

Squelch level

Sets a squelch level.

- Range: 0 (open) ~ 9 (tight)

AF minimum level

Sets a minimum audio output level. This function determines the minimum audio output level not to let the audio level become lower than the selected level.

- Range: 0 ~ 100

Mic gain

Sets a microphone sensitivity.

- Range: 1 (low) ~ 5 (high)

VOX

Turns the VOX function ON or OFF.

- ① To use the function, a headset is required (purchase separately).

VOX gain

Sets a VOX gain.

The VOX function automatically switches between receive and transmit by detecting your voice. Higher values make the VOX function more sensitive to your voice.

- Range: 1 ~ 10

VOX delay (Sec)

Sets the period of time the transceiver continues transmitting after the user stops speaking, and then the VOX switches to receive.

- Range: 0.5 ~ 3.0 seconds

Horn

Turns the Horn function ON or OFF.

- ① An external horn is required to use the function.

Battery voltage

Selects whether or not to display the battery voltage when turning ON the transceiver.

Signal moni

Selects whether or not to release the mute while using a 2-Tone, 5-Tone, or DTMF code signaling.

Lone worker

Selects whether or not to automatically enter the Emergency mode when no operation occurs during the preset period of time.

System info

Displays the Vocoder Error Rate (VER) and Received Signal Strength Indicator (RSSI) of the received signal.

NXDN™ system operation	6-2
Receiving a call	6-3
◇ Receiving an Individual call	6-3
◇ Receiving a Group call.....	6-3
◇ Receiving a Status message	6-3
◇ Receiving a Message	6-3
◇ Receiving a Call Alert call	6-3
◇ Receiving a Radio Check call	6-3
◇ Receiving a Remote Monitor call	6-3
◇ Receiving a Stun, Kill or Revive.....	6-4
◇ Receiving an Emergency call	6-4
Transmitting a call	6-5
◇ Transmitting an Individual or a Group call	6-5
◇ Transmitting a Status message	6-6
◇ Transmitting a Message.....	6-7
◇ Transmitting a Call Alert call	6-8
◇ Transmitting an Emergency call	6-8
◇ Transmitting Position data	6-8
Call log.....	6-9
◇ Displaying the Call log	6-9
Encryption function	6-9

NXDN™ system operation

NXDN has a new “Common Air Interface” (CAI), the name for over-the-air methods by which transceivers and repeaters communicate. NXDN defines the next-generation digital transceiver.

The NXDN system has two operating modes, Conventional and Trunking. In a Conventional system, you manually search for an empty channel. In a Trunking system, the transceiver automatically searches for an empty channel, and sends the information to the target transceiver through a repeater. In this way, the target transceiver automatically selects the receive mode to reply to a received call.

If you use an NXDN transceiver, you can transmit or receive an Individual Call, Group Call, Status Message, Message, Call Alert call, and so on.

The transceiver supports the following systems:

- **NXDN Conventional operation**

The NXDN Conventional system enables efficient Conventional operation in the digital mode.

- **Multi-site Conventional operation**

The Multi-site Conventional system can support up to 16 sites (each site has one repeater) through an IP network, and enables efficient Conventional operation in the digital mode.

- **Single-site Trunking operation**

The Single-site Trunking system enables further effective channel management by sharing a minimum number of channels with a large number of users.

Receiving a call

◇ Receiving an Individual call

When an Individual call has been received:

- Mute is released.
- “” is displayed.
- The calling station name (or ID) is displayed while receiving the signal.*



1. Hold down [PTT] to speak.
2. Release [PTT] to receive.

◇ Receiving a Group call

When a Group call has been received:



- Mute is released.
 - “” is displayed.
 - The Group name and the calling station name (or ID) are alternately displayed while receiving the call.
- ① When an All Call is received, “All Call” is displayed.*
In that case, you cannot reply to it.



1. Hold down [PTT] to speak.
2. Release [PTT] to receive.

◇ Receiving a Status message

When a Status message has been received:



- Beeps sound.
- “” blinks.
- The Status message and the calling station or Group name (or ID) are alternately displayed.
- “” may be displayed or blink, depending on the presetting.



- Push any key to stop the display indication.

◇ Receiving a Message

When a Message has been received:

- Beeps sound.
- “” blinks.
- The Message and the calling station or Group name (or ID) are alternately displayed.
- “” may be displayed or blink, depending on the presetting.



- Push [PTT] or any key to stop the display indication.

◇ Receiving a Call Alert call

When a Call Alert call has been received:

- Beeps sound.
- “CALLALRT” and the calling station or Group name (or ID) are alternately displayed.
- “” may be displayed or blink, depending on the presetting.



1. Hold down [PTT] to speak.
2. Release [PTT] to receive.

◇ Receiving a Radio Check call

When a Radio check command has been received, the transceiver automatically transmits an acknowledgment call. The RAN code matching may not be necessary, depending on the presetting.

◇ Receiving a Remote Monitor call

When a Remote monitor call has been received, the microphone audio is automatically transmitted for a set time period. The RAN code matching may not be necessary, depending on the presetting.

*The message may differ, depending on the presetting.

Receiving a call

◇ Receiving a Stun, Kill or Revive

If a Stun or Kill command has been received, the transceiver will display the stun text and you cannot receive or transmit.



If a Stun command is received, you cannot operate the transceiver until a Revive command is received, or the password is input.

If a Kill command is received, you cannot operate the transceiver until it is reprogrammed.

NOTE:

- Depending on the presetting, the transceiver can ignore the Stun, Revive and Kill commands that are from a non-specified station.
- Depending on the presetting, reception may be enabled.

◇ Receiving an Emergency call

When an Emergency call has been received:

- Beeps sound.
- “Emer” and the calling station name (or ID) are alternately displayed. The message may differ, depending on the presetting.



- When the Send Ack function is set to ON by presetting, the transceiver automatically transmits an acknowledgment to the calling station, if the received call type is a Group or All call.
 - ① If the received call type is Individual, and it requests an acknowledgment be sent back, the transceiver automatically sends the acknowledgment.
 1. Hold down [PTT] to speak.
 2. Turn OFF the transceiver, change the channel, or push [PTT] or a key to stop the beep and display indication.

Transmitting a call

NXDN operation enables you to make a call to a specific station (Individual call) or to a particular group (Group call). Other digital mode transceivers on the channel will not receive a call that does not match their Individual or Group ID and/or Radio Access Number (RAN) code.

◆ Transmitting an Individual or a Group call

- ① Assign the function [Digital Button] to the assignable key.
- 1. Push [Digital Button] to enter the Application selection mode.
 - According to the current call type, “INDIV” (Individual call) or “GROUP” (Group call) is briefly displayed, and then “VOICE” is displayed.
 - ① If you want to change the call type, hold down [Digital Button] for 1 second in the Standby mode.



- 2. Push [Digital Button] to select voice call.
- 3. Push [CH Up] or [CH Down] to select an Individual station or a Group.



- 4. Push [PTT] to transmit a call.
- 5. Hold down [PTT] to speak.
- 6. Release [PTT] to receive.

TIP:

- You can also directly enter the Individual station (or Group) selection mode by pushing [Call List Select], depending on the presetting.
- When an Individual ID is set in the Memory CH, you can transmit the Individual call by pushing [PTT] on the channel.

Transmitting a call

◇ **Transmitting a Status message**

You can transmit a preset simple message. You cannot transmit a voice signal at the same time.
 ① Assign the function [Digital Button] to the assignable key.

1. Push [Digital Button] to enter the Application selection mode.
 - According to the current call type, “INDIV” (Individual call) or “GROUP” (Group call) is briefly displayed, and then “VOICE” is displayed.
 - ① If you want to change the call type, hold down [Digital Button] for 1 second in the Standby mode.
2. Push [CH Up] or [CH Down] to select “STATUS,” and then push [Digital Button].



3. Push [CH Up] or [CH Down] to select a status, and then push [Digital Button].
4. Push [CH Up] or [CH Down] to select an Individual station or a Group.



5. Push [PTT] to transmit a Status message.
 - “SUCCESS” is displayed when an acknowledgment is received from the targeted station.
 - “FAILED” is displayed if an acknowledgment is not received from the targeted station.

TIP: Hold down [Status] for 1 second to transmit the preset Status message.

NOTE: If the following settings are configured using the CS-F5130D PROGRAMMING SOFTWARE, the Status message can be automatically transmitted when:

- The transceiver is turned ON or OFF.
 - ① Set the Status message to be transmitted in **Power ON Status** or **Power OFF Status**, respectively.
 - ① Set the target station ID in **Power Status ID for Conventional** or **Power Status ID for Single-site Trunk**.
(Digital > Status > **Status Settings**)
- After sending a voice message.
 - ① Set **Send with Voice Call** to “Enable.”
 - ① Set the Status message to be transmitted in **Send Status Number**.
(Digital > Status > **Status Settings**)

Transmitting a call

◇ Transmitting a Message

You can transmit a message of up to 100 characters.

① Assign the function [Digital Button] to the assignable key.

1. Push [Digital Button] to enter the Application selection mode.
 - According to the current call type, “INDIV” (Individual call) or “GROUP” (Group call) is briefly displayed, and then “VOICE” is displayed.
 - ① If you want to change the call type, hold down [Digital Button] for 1 second in the Standby mode.
2. Push [CH Up] or [CH Down] to select “MSG,” and then push [Digital Button].

TIP:

- Push [Message] to directly enter the Message selection screen in step 3 to the left.
- Hold down [Message] for 1 second to transmit the preset Message.

NOTE: Set the Message to be transmitted using the CS-F5130D PROGRAMMING SOFTWARE. (Digital > Message > **Message List**)



Push [CH Up] or [CH Down] to select a message, and then push [Digital Button].



3. Push [CH Up] or [CH Down] to select an Individual station or a Group.



4. Push [PTT] to transmit a Message.
 - “SUCCESS” is displayed when an acknowledgment is received from the targeted station.
 - “FAILED” is displayed if an acknowledgment is not received from the targeted station.

Transmitting a call

◇ Transmitting a Call Alert call

A Call Alert call enables you to notify another user who may be away from the transceiver that you want to talk.

① Assign the function [Digital Button] to the assignable key.

1. Push [Digital Button] to enter the Application selection mode.
 - According to the current call type, “INDIV” (Individual call) or “GROUP” (Group call) is briefly displayed, and then “VOICE” is displayed.
 - ① If you want to change the call type, hold down [Digital Button] for 1 second in the Standby mode.
2. Push [CH Up] or [CH Down] to select “CALLALRT,” and then push [Digital Button].



3. Push [CH Up] or [CH Down] to select an Individual station or a Group.



4. Push [PTT] to transmit a Call Alert call.
 - “SUCCESS” is displayed when an acknowledgment is received from the targeted station.
 - “FAILED” is displayed if an acknowledgment is not received from the targeted station.

TIP: Hold down [Call Alert] for 1 second to transmit the Call Alert call.

◇ Transmitting an Emergency call

An NXDN Emergency call can be transmitted in the same way as the 2-Tone, 5-Tone, or MDC 1200 signaling operation. See “Emergency call” for details. (pp. 5-2 ~ 5-3)

◇ Transmitting Position data

When the GPS function is ON, and the external GPS receiver* receives Position data, the longitude and latitude data can be automatically transmitted:

- When a GPS request status message is received.
- At the preset interval.
 - ① Set the **Auto** to “Enable.”
 - ① Set the **Interval Timer [mm:ss]**.
- After sending a voice message.
 - ① Set the **Send with Login** and **Send with Logoff** to “Enable.”
- After sending a Status Message.
 - ① Set the **Send with Status Call** to “Enable.”
- After sending a Call Alert.
 - ① Set the **Send with Call Alert** to “Enable.”
- After sending an Emergency call.
 - ① Set the **Send with Emergency** to “Enable.”

* The optional OPC-2078 ACC CABLE is required to connect the external GPS receiver.

NOTE: To transmit position data, the settings above are required using the CS-F5130D PROGRAMMING SOFTWARE.
(GPS > GPS Settings)

Call log

The transceiver saves a log of the received Individual calls, Call Alert calls, Status Messages, and Messages in the memory, depending on the presetting.

Up to 10 received calls can be saved, and the oldest log is deleted when an 11th call is received. However, once the transceiver is turned OFF, the all records are deleted.

◇ Displaying the Call log

① Assign the function [Digital Button] to the assignable key.

1. Push [Digital Button] to enter the Application selection mode.
2. Push [CH Up] or [CH Down] to select “CALL LOG,” and then push [Digital Button].



3. Push [CH Up] or [CH Down] to select the Log, and then push [Digital Button].
 - The Station Name or ID and the received call type, Status Message, or Message of the latest received call are alternately displayed.



NOTE: To save the call log, set the Call Log settings using the CS-F5130D PROGRAMMING SOFTWARE. (Digital > Option > **Call Log**)

Encryption function

The Encryption function enables voice scrambling, which provides private digital communication between stations.

When an encrypted call is received, the squelch will open only when the call contains a matching Key ID*. If a call containing a different Key ID* is made on the same channel, the squelch will not open, and the user will not hear the call.

* Depending on the presetting, opening the squelch may also require that a matching RAN is included in the call.

① Assign the function [Encryption] to the assignable key.

- Push [Encryption] to turn the Encryption function ON or OFF.
 - “” is displayed when the Encryption function is ON.
- ① When the Encryption function is ON, push [PTT] to make an encrypted call.

Section 7

MDC 1200 SYSTEM OPERATION

- MDC 1200 system operation7-2
- Receiving a call7-3
 - ◇ Receiving a PTT ID call7-3
 - ◇ Receiving an MDC Emergency call7-3
 - ◇ Receiving an MDC Stun or Revive call7-3
- Transmitting a call7-4
 - ◇ Transmitting a PTT ID call7-4
 - ◇ Transmitting an MDC Emergency call7-4
 - ◇ Transmitting an MDC Emergency Acknowledgment.....7-4

MDC 1200 system operation

This function is usable in only the Analog mode.

The MDC 1200 signaling system enhances your transceiver's capabilities. The user can receive and transmit PTT ID and Emergency calls, and receive Radio Check, Stun, and Revive calls.

NOTE: Set the related settings using the CS-F5130D PROGRAMMING SOFTWARE when using the MDC 1200 system.
(Analog > MDC > **System**)

Receiving a call

◇ Receiving a PTT ID call

When a PTT ID call has been received:

- Beeps sound, depending on the presetting.
- The calling station's ID is displayed.*1



◇ Receiving an MDC Emergency call

When an MDC Emergency call has been received:

- Beeps sound.
- The calling station's ID and "Emer" is alternately displayed.*1



- Hold down [PTT] to speak.
 - ① The transceiver may automatically transmit an acknowledgment to the calling station, depending on the setting.
 - ① To stop the Emergency beeps, turn OFF the transceiver, change the channel, or push [PTT] or a key.

◇ Receiving an MDC Stun or Revive call

If an MDC Stun call has been received that matches your station ID, the transceiver displays the stun text and you cannot receive*2 or transmit.



To use the transceiver again, you need to:

- Receive*2 an MDC Revive call that matches your station ID.
- Enter the password.
- Setup again using the CS-F5130D PROGRAMMING SOFTWARE.

*1 The message may differ, depending on the presetting.

*2 The reception may be enabled, depending on the presetting.

Transmitting a call

◇ Transmitting a PTT ID call

You can transmit a call with your station ID. When another station receives a PTT ID call, your station name (or ID) is displayed.

- Push [PTT] to make a call.
 - Beeps sound, depending on the presetting.
 - Your station ID is transmitted when you push [PTT] (at the beginning of the transmission) or release [PTT] (at the end of transmission), depending on the presetting.

◇ Transmitting an MDC Emergency call

An MDC Emergency call can be transmitted in the same way as the 2-Tone, 5-Tone, or NXDN™ signaling operation. See “Emergency call” for details. (pp. 4-2 ~ 4-3)

The transceiver can also be set to keep the microphone open in the Emergency mode to monitor the situation, depending on the presetting.

◇ Transmitting an MDC Emergency Acknowledgment

When receiving an MDC Emergency call, an MDC Emergency Acknowledgment is automatically transmitted, depending on the presetting.

Section 8 OPTIONS

Options8-2

Options

- **HM-152/HM-152T/HM-148G/HM-148T** HAND MICROPHONES
 - HM-152: Hand microphone
 - HM-152T: DTMF microphone
 - HM-148G: Self ground heavy duty microphone
 - HM-148T: Self ground heavy duty DTMF microphone
- **HM-211** NOISE CANCELING MICROPHONE
- **HM-239T** DTMF MICROPHONE
- **SM-26** DESKTOP MICROPHONE
Desktop microphone with a monitor switch.
- **SP-30/SP-35/SP-35L** EXTERNAL SPEAKERS
Input impedance: 4 Ω
 - SP-30: Rated input 20 W, Maximum input 30 W
 - SP-35/SP-35L: Rated input 5 W, Maximum input 7 W
- **OPC-1939/OPC-2078** ACC CABLES
Used to connect an external device.
 - OPC-1939: D-sub 15-pin, an external level converter (user supplied) is required.
 - OPC-2078: D-sub 25-pin, built-in level converter
- **OPC-2478/OPC-2479** DC POWER CABLES
- **CS-F5130D** PROGRAMMING SOFTWARE
+ **OPC-2344/OPC-2344-1** PROGRAMMING CABLE
The software to program the transceiver. Use the OPC-2344 or OPC-2344-1 to connect the transceiver to a PC.

