



## INSTRUCTION MANUAL

VHF MARINE TRANSCEIVERS

# IC-M605 IC-M605EURO



Icom Inc.

Thank you for choosing this Icom product.

This product is designed and built with Icom's state of the art technology and craftsmanship.

With proper care, this product should provide you with years of trouble-free operation.

The IC-M605/IC-M605EURO VHF MARINE TRANSCEIVER has DSC functions for distress alert transmission and reception, as well as the general DSC calls (Individual calls, All Ships calls, Group calls, and so on).

---

## IMPORTANT

---

**READ ALL INSTRUCTIONS** carefully and completely before using the transceiver.

**SAVE THIS INSTRUCTION MANUAL** — This instruction manual contains important operating instructions for the IC-M605/IC-M605EURO.

Icom is not responsible for the destruction, damage to, or performance of any Icom or non-Icom equipment, if the malfunction is because of:

- Force majeure, including, but not limited to, fires, earthquakes, storms, floods, lightning, other natural disasters, disturbances, riots, war, or radioactive contamination.
- The use of Icom transceivers with any equipment that is not manufactured or approved by Icom.

---

## EXPLICIT DEFINITIONS

---

WORD	DEFINITION
<b>⚠ WARNING!</b>	Personal injury, fire hazard or electric shock may occur.
<b>CAUTION</b>	Equipment damage may occur.
<b>NOTE</b>	If disregarded, inconvenience only. No risk of personal injury, fire or electric shock.

**CLEAN THE FRONT PANEL THOROUGHLY IN A BOWL OF FRESH WATER** after exposure to saltwater, and dry it before operating. Otherwise, the front panel's keys, switches, and controllers may become unusable, due to salt crystallization, and/or the charging terminals of the battery pack may corrode.

**NOTE:** If the front panel's waterproof protection appears defective, carefully clean it with a soft, damp (fresh water) cloth, then dry it before operating. The front panel may lose its waterproof protection if the case, jack cap, or connector cover is cracked or broken, or the front panel has been dropped. Contact your Icom distributor or your dealer for advice.

Icom, Icom Inc. and Icom logo are registered trademarks of Icom Incorporated (Japan) in Japan, the United States, the United Kingdom, Germany, France, Spain, Russia, Australia, New Zealand, and/or other countries. AquaQuake™ is a trademark of Icom Incorporated.

---

## IN CASE OF EMERGENCY

---

If your vessel requires assistance, contact other vessels and the Coast Guard by sending a Distress call on Channel 16.

### **USING CHANNEL 16**

#### **DISTRESS CALL PROCEDURE**

1. "MAYDAY MAYDAY MAYDAY."
2. "THIS IS ....." (name of vessel).
3. Say your call sign or other description of the vessel (AND 9 digit DSC ID if you have one).
4. "LOCATED AT ....." (your position).
5. State the nature of the distress and assistance required.
6. Give any other information which might facilitate the rescue.

Or, transmit your Distress call using Digital Selective Calling on Channel 70.

### **USING DIGITAL SELECTIVE CALLING (Ch 70)**

#### **DISTRESS CALL PROCEDURE**

1. While lifting up the key cover, hold down [DISTRESS] for 3 seconds until you hear 3 short beeps and then one long beep.
2. Wait for an acknowledgment on Channel 70 from a coast station.
  - After the acknowledgement is received, Channel 16 is automatically selected.
3. Hold down [PTT], then transmit the appropriate information as listed above.

---

## INSTALLATION NOTE

---

### **Installation:**

The installation of this equipment should be made in such a manner as to respect the EC recommended electromagnetic field exposure limits. (1999/519/EC)

The maximum RF power available from this device is 25 watts. The antenna should be installed as high as possible for maximum efficiency and the installation height should be at least 1.76 meters above any accessible position. In the case where an antenna cannot be installed at a reasonable height, then the transmitter should neither be continuously operated for long periods if any person is within a distance of 1.76 meters of the antenna, nor operated at all if any person is touching the antenna.

It is recommended that antenna of a maximum gain of 3 dB is used. If higher gain antenna are required then please contact your Icom distributor for revised installation recommendations.

### **Operation:**

The exposure to RF electromagnetic field is only applicable when this device is transmitting. This exposure is naturally reduced due to the nature of alternating periods of receiving and transmitting. Keep your transmissions to the minimum necessary.

---

# RADIO OPERATOR WARNING

---



**WARNING**

Icom requires the radio operator to meet the FCC Requirements for Radio Frequency Exposure. An omnidirectional antenna with gain not greater than 9 dBi must be mounted a minimum of 5 meters (measured from the lowest point of the antenna) vertically above the main deck and all possible

personnel. This is the minimum safe separation distance estimated to meet all RF exposure compliance requirements. This 5 meter distance is based on the FCC Safe Maximum Permissible Exposure (MPE) distance of 3 meters added to the height of an adult (2 meters) and is appropriate for all vessels.

For watercraft without suitable structures, the antenna must be mounted so as to maintain a minimum of 1 meter vertically between the antenna, (measured from the lowest point of the antenna), to the heads of all persons AND all persons must stay outside of the 3 meter MPE radius.

Do not transmit with radio and antenna when persons are within the MPE radius of the antenna, unless such persons (such as driver or radio operator) are shielded from antenna field by a grounded metallic barrier. The MPE Radius is the minimum distance from the antenna axis that person should maintain in order to avoid RF exposure higher than the allowable MPE level set by FCC.

**FAILURE TO OBSERVE THESE LIMITS MAY ALLOW THOSE WITHIN THE MPE RADIUS TO EXPERIENCE RF RADIATION ABSORPTION WHICH EXCEEDS THE FCC MAXIMUM PERMISSIBLE EXPOSURE (MPE) LIMIT.**

**IT IS THE RESPONSIBILITY OF THE RADIO OPERATOR TO ENSURE THAT THE MAXIMUM PERMISSIBLE EXPOSURE LIMITS ARE OBSERVED AT ALL TIMES DURING RADIO TRANSMISSION. THE RADIO OPERATOR IS TO ENSURE THAT NO BYSTANDERS COME WITHIN THE RADIUS OF THE MAXIMUM PERMISSIBLE EXPOSURE LIMITS.**

## **Determining MPE Radius**

**THE MAXIMUM PERMISSIBLE EXPOSURE (MPE) RADIUS HAS BEEN ESTIMATED TO BE A RADIUS OF ABOUT 3M PER OET BULLETIN 65 OF THE FCC.**

**THIS ESTIMATE IS MADE ASSUMING THE MAXIMUM POWER OF THE RADIO AND ANTENNAS WITH A MAXIMUM GAIN OF 9dBi ARE USED FOR A SHIP MOUNTED SYSTEM.**

---

# AVERTISSEMENT POUR LES OPÉRATEURS RADIO

---



AVERTISSEMENT

Icom exige que l'opérateur radio se conforme aux exigences de la FCC en matière d'exposition aux radiofréquences. Une antenne omnidirectionnelle dont le gain ne dépasse pas 9dBi doit être fixée à une distance minimale de 5 mètres (mesurée depuis le point le plus bas de l'antenne)

verticalement au-dessus du pont principal et de tout le personnel qui peut s'y trouver. Il s'agit de la distance de sécurité minimale prévue pour satisfaire aux exigences de conformité en matière d'exposition aux RF. Cette distance de 5 mètres est établie en fonction de l'exposition maximale admissible sécuritaire de 3 mètres établie par la FCC, à laquelle on ajoute la hauteur d'un adulte (2 mètres); cette distance convient pour tous les navires.

Dans le cas des embarcations sans structure convenable, l'antenne doit être fixée de façon à maintenir une distance minimale de 1 mètre verticalement entre cette antenne (mesurée depuis son point le plus bas) et la tête de toute personne présente; toutes les personnes présentes doivent se tenir à l'extérieur d'un rayon d'exposition maximale admissible de 3 mètres.

Ne pas émettre à l'aide de la radio et de l'antenne lorsque des personnes se trouvent à l'intérieur du rayon d'exposition maximale admissible de cette antenne, à moins que ces personnes (comme le conducteur ou l'opérateur radio) ne soient protégées du champ de l'antenne par un écran métallique relié à la masse. Le rayon d'exposition maximale admissible équivaut à la distance minimale que cette personne doit maintenir entre elle et l'axe de l'antenne pour éviter une exposition aux RF supérieure au niveau d'exposition maximale admissible fixé par la FCC.

**LE NON-RESPECT DE CES LIMITES PEUT CAUSER, POUR LES PERSONNES SITUÉES DANS LE RAYON D'EXPOSITION MAXIMALE ADMISSIBLE, UNE ABSORPTION DE RAYONNEMENT DE RF SUPÉRIEURE À L'EXPOSITION MAXIMALE ADMISSIBLE FIXÉE PAR LA FCC. L'OPÉRATEUR RADIO EST RESPONSABLE D'ASSURER QUE LES LIMITES D'EXPOSITION MAXIMALE ADMISSIBLE SOIENT RESPECTÉES EN TOUT TEMPS PENDANT LA TRANSMISSION RADIO. L'OPÉRATEUR RADIO DOIT S'ASSURER QU'AUCUNE PERSONNE PRÉSENTE NE SE SITUE À L'INTÉRIEUR DU RAYON D'EXPOSITION MAXIMALE ADMISSIBLE.**

**Établir le rayon d'exposition maximale admissible ON ESTIME QUE LE RAYON D'EXPOSITION MAXIMALE ADMISSIBLE EST D'ENVIRON 3 M, TEL QUE STIPULÉ DANS LE BULLETIN OET 65 DE LA FCC. CETTE DISTANCE ESTIMÉE TIEN COMTE D'UN SYSTÈME INSTALLÉ SUR UN NAVIRE UTILISANT LA PUISSANCE MAXIMALE DE LA RADIO ET DES ANTENNES DONT LE GAIN MAXIMAL EST DE 9dBi.**

---

## FCC INFORMATION

---

This equipment has been tested and found to comply with the limits for a Class A digital device, pursuant to part 15 of the FCC Rules. These limits are designed to provide reasonable protection against harmful interference when the equipment is operated in a commercial environment. This equipment generates, uses, and can radiate radio frequency energy and, if not installed and used in accordance with the instruction manual, may cause harmful interference to radio communications.

Operation of this equipment in a residential area is likely to cause harmful interference in which case the user will be required to correct the interference at his own expense.

**CAUTION:** Changes or modifications to this device, not expressly approved by Icom Inc., could void your authority to operate this device under FCC regulations.

---

## NOTE

---

**A WARNING STICKER** is supplied with the USA version transceiver.

To comply with FCC regulations, this sticker must be affixed in such a location as to be readily seen from the operating controls of the radio as in the diagram below. Make sure the chosen location is clean and dry before applying the sticker.

### EXAMPLE



---

## PRECAUTIONS

---

⚠ **WARNING! NEVER** connect the transceiver to an AC outlet. This may pose a fire hazard or result in an electric shock.

⚠ **WARNING! NEVER** connect the transceiver to a power source of more than 16 V DC such as a 24 V battery. This could damage the transceiver.

⚠ **WARNING! NEVER** reverse the DC power cable polarity when connecting to a power source. This could damage the transceiver.

⚠ **WARNING! NEVER** cut the DC power cable between the DC plug at the back of the transceiver and the fuse holder. If an incorrect connection is made after cutting, the transceiver may be damaged.

⚠ **WARNING! NEVER** operate the transceiver during a lightning storm. It may result in an electric shock, cause a fire or damage the transceiver. Always disconnect the power source and antenna before a storm.

⚠ **WARNING! NEVER** place the transceiver where normal operation of the vessel may be hindered, or where it could cause bodily injury.

**CAUTION: KEEP** the transceiver and microphone at least 1 meter away from the vessel's magnetic navigation compass.

**CAUTION: DO NOT** place or leave the transceiver in areas with temperatures below  $-20^{\circ}\text{C}$  ~  $+60^{\circ}\text{C}$  ( $-4^{\circ}\text{F}$  ~  $+140^{\circ}\text{F}$ ), or in areas subject to direct sunlight, such as a dashboard.

**CAUTION: DO NOT** use harsh solvents such as Benzine or alcohol to clean the transceiver, as they will damage the transceiver's surfaces. If the transceiver becomes dusty or dirty, wipe it clean with a soft, dry cloth.

**BE CAREFUL!** The transceiver rear panel will become hot when transmitting continuously for long periods of time.

Place the transceiver in a secure place to avoid inadvertent use by unauthorized persons.

**BE CAREFUL!** The transceiver's front panel meets IPX8 requirements and the optional HM-195/HM-229 COMMANDMIC meet IPX7 requirements for waterproof protection\*. However, once the transceiver or microphone has been dropped, or the waterproof seal is cracked or damaged, waterproof protection cannot be guaranteed because of possible damage to the case or the waterproof seal.

\* Except for the DC power connector, NMEA In/Out leads and AF Out leads.

---

# PRÉCAUTIONS

---

⚠ **AVERTISSEMENT ! NE JAMAIS** relier l'émetteur-récepteur à une prise CA. Cela pourrait provoquer un choc électrique ou un incendie.

⚠ **AVERTISSEMENT ! NE JAMAIS** brancher l'émetteur-récepteur sur une source d'alimentation supérieure à 16 V CC, comme une batterie de 24 V. Cela pourrait endommager l'émetteur-récepteur.

⚠ **AVERTISSEMENT ! NE JAMAIS** inverser la polarité du câble d'alimentation CC lors de la connexion à une source d'alimentation. Cela pourrait endommager l'émetteur-récepteur.

⚠ **AVERTISSEMENT ! NE JAMAIS** couper le câble d'alimentation CC entre la prise CC à l'arrière de l'émetteur-récepteur et le porte-fusible. L'émetteur-récepteur peut être endommagé par la suite en cas de connexion inappropriée.

⚠ **AVERTISSEMENT ! NE JAMAIS** utiliser l'émetteur-récepteur durant un orage. Cela risquerait de provoquer un choc électrique, un incendie ou d'endommager l'émetteur-récepteur. Toujours débrancher la source d'alimentation et l'antenne avant une tempête.

**MISE EN GARDE : NE JAMAIS** installer l'émetteur-récepteur à un emplacement où il pourrait gêner le fonctionnement normal du navire ou provoquer des blessures corporelles.

**INSTALLER** la VHF et le microphone à au moins 1 m du compas de route du navire.

**NE PAS** utiliser ou placer l'émetteur-récepteur dans des zones où la température est inférieure à  $-15^{\circ}$  ou supérieure à  $+55^{\circ}$  ou dans des zones soumises au rayonnement solaire direct, telles le tableau de bord.

**NE PAS** nettoyer l'appareil avec des solvants agressifs tels que benzène ou alcool, susceptibles d'endommager les surfaces exposées du boîtier. En cas de dépôt de poussière ou de salissures sur l'émetteur-récepteur, il faut l'essuyer avec chiffon doux et sec.

**MISE EN GARDE !** La face arrière de la VHF chauffe en cas d'utilisation continue sur une longue durée.

Placer l'émetteur-récepteur hors de portée des enfants pour éviter toute utilisation inopinée.

**MISE EN GARDE !** La face avant de l'émetteur-récepteur est étanche conformément à la norme IPX7\*. L'étanchéité ne peut plus être garantie après une chute de l'appareil en raison des risques de fissures du boîtier, de dégradation du joint d'étanchéité, etc.

\*Les connecteurs sur le panneau arrière ne sont pas étanche IPX7.

Si la face avant est exposée à de l'eau de mer, **ASSUREZ-VOUS DE LE NETTOYER ENTIÈREMENT AVEC DE L'EAU DOUCE** lorsque la protection étanche sur le panneau avant fonctionne. Dans le cas contraire, les touches et le commutateur risquent de ne plus fonctionner en raison de la cristallisation du sel.

Icom ne peut pas être tenu pour responsable de la destruction, de la détérioration ou des performances d'un équipement Icom ou non-Icom, si le dysfonctionnement survient à cause de :

- Force majeure, sans toutefois s'y limiter, les incendies, tremblements de terre, tempêtes, inondations, la foudre, d'autres catastrophes naturelles, perturbations, émeutes, guerre, ou contamination radioactive.
- L'utilisation d'un émetteur-récepteur Icom avec tout équipement non fabriqué ou approuvé par Icom.



## ACTION ICON DESCRIPTION

The following describes the [CH/ENT], [ENT] and the keypad operations in this instruction manual.

Rotate



: Rotate [CH/ENT] to select.

Push





: Push [ENT] to enter or set.

Push



: Push the keypad to enter a digit or text.

Also, you can use the following key functions in the Menu screen.

FUNCTION	ACTION
<b>Select</b>	Rotate [CH/ENT]. Push [▲] or [▼].
<b>Enter</b>	Push [ENT], [CH/ENT], or [Enter]  .
<b>Go to the next tree level</b>	Push [ENT] or [▶].
<b>Go back to the previous tree level</b>	Push [CLR], [◀], or [Back]  .
<b>Cancel</b>	Push [CLR].
<b>Exit</b>	Push [MENU] or [Exit]  .

## TABLE OF CONTENTS

IMPORTANT.....	i
EXPLICIT DEFINITIONS.....	i
IN CASE OF EMERGENCY.....	ii
INSTALLATION NOTE.....	ii
RADIO OPERATOR WARNING.....	iii
AVERTISSEMENT POUR LES OPÉRATEURS RADIO.....	iv
FCC INFORMATION.....	v
NOTE.....	v
PRECAUTIONS.....	vi
PRÉCAUTIONS.....	vii
ACTION ICON DESCRIPTION.....	viii
<b>1 OPERATING RULES.....</b>	<b>1</b>
<b>2 PANEL DESCRIPTION.....</b>	<b>2-8</b>
■ Front panel.....	2
■ Software Key function.....	5
■ Speaker Microphone.....	6
■ Function display (Main screen).....	6
<b>3 PREPARATION.....</b>	<b>9-10</b>
■ Entering the MMSI code.....	9
■ Entering the ATIS code (For Dutch and German versions)...	10
<b>4 MENU SCREEN.....</b>	<b>11</b>
■ Construction.....	11
■ Selecting a Menu item.....	13
<b>5 BASIC OPERATION.....</b>	<b>14-21</b>
■ Selecting a channel.....	14
■ Setting the Call channel.....	17
■ Microphone Lock function.....	17
■ Receiving and transmitting.....	18
■ Backlight function.....	19
■ Entering a Channel name.....	20
■ Using the AquaQuake water draining function.....	21

---

# TABLE OF CONTENTS (Continued)

---

<b>6 SCAN OPERATION (Except for the Dutch version).....</b>	<b>22–23</b>	<b>11 MENU ITEMS.....</b>	<b>84–93</b>
■ Scan types.....	22	■ Menu items.....	84
■ Favorite channels.....	23	■ GPS Information.....	85
■ Starting a scan.....	23	■ Configuration.....	85
<b>7 DUALWATCH/TRI-WATCH (Except for the Dutch version) ..</b>	<b>24</b>	■ Radio Settings.....	88
■ Description.....	24	■ NMEA Settings.....	91
■ Operation.....	24	■ Radio Information.....	93
<b>8 DSC OPERATION.....</b>	<b>25–66</b>	<b>12 CONNECTIONS AND MAINTENANCE.....</b>	<b>94–101</b>
■ DSC address ID.....	25	■ Connections.....	94
■ Entering the position and time.....	27	■ Antenna.....	96
■ DSC Task mode (Single).....	29	■ Fuse replacement.....	96
■ DSC Task mode (Multiple).....	30	■ Cleaning.....	96
■ Sending a Distress call.....	31	■ Supplied accessories.....	97
■ Sending a Non-Distress call.....	37	■ Mounting the transceiver.....	98
■ Receiving DSC calls.....	47	■ MB-132 installation.....	99
■ Received Call log.....	58	■ Microphone installation.....	100
■ Transmitted Call log.....	59	<b>13 SPECIFICATIONS AND OPTIONS.....</b>	<b>102–105</b>
■ DSC Settings.....	60	■ Specifications.....	102
■ Making an Individual call to a particular AIS target.....	65	■ Options.....	104
<b>9 OTHER FUNCTIONS.....</b>	<b>67–72</b>	<b>14 TROUBLESHOOTING.....</b>	<b>106–107</b>
■ Using the Intercom.....	67	<b>15 CHANNEL LIST.....</b>	<b>108–110</b>
■ Using the RX Hailer.....	68	<b>16 INFORMATION.....</b>	<b>111</b>
■ Using the Hailer.....	68	■ About CE and DOC.....	111
■ Using the Horn.....	69	■ Disposal.....	111
■ Using the Voice Scrambler.....	71	<b>INDEX.....</b>	<b>112–114</b>
■ Using the Voice Recorder.....	72		
<b>10 AIS RECEIVER.....</b>	<b>73–83</b>		
■ About AIS.....	73		
■ AIS Classes.....	73		
■ Function display.....	74		
■ About the detail screen.....	76		
■ AIS Settings.....	80		

## ◇ Priorities

- Read all rules and regulations pertaining to call priorities, and keep an up-to-date copy handy. Safety and distress calls take priority over all others.
- You must monitor Channel 16 when you are not operating on another channel.
- False or fraudulent distress calls are prohibited under law.

## ◇ Privacy

- Information overheard, but not intended for you, cannot lawfully be used in any way.
- Indecent or profane language is prohibited.

## ◇ Radio licenses

### (1) SHIP STATION LICENSE

You may require a current radio station license before using the transceiver. It is unlawful to operate a ship station which is not licensed, but required to be.

If required, contact your dealer or the appropriate government agency for a Ship-Radiotelephone license application. This government-issued license states the call sign which is your craft's identification for radio purposes.

### (2) OPERATOR'S LICENSE

A Restricted Radiotelephone Operator Permit is the license most often held by small vessel radio operators when a radio is not required for safety purposes.

If required, the Restricted Radiotelephone Operator Permit must be posted or kept with the operator. If required, only a licensed radio operator may operate a transceiver.

However, non-licensed individuals may talk over a transceiver if a licensed operator starts, supervises, ends the call and makes the necessary log entries.

A current copy of the applicable government rules and regulations is only required to be on hand for vessels in which a radio telephone is compulsory. However, even if you are not required to have these on hand it is your responsibility to be thoroughly acquainted with all pertinent rules and regulations.

**NOTE:** Even though the transceiver is capable of operation on VHF marine channels 1021, 1023, 1081, 1082 and 1083, according to FCC regulations these simplex channels cannot be lawfully used by the general population in USA waters.

## ■ Front panel

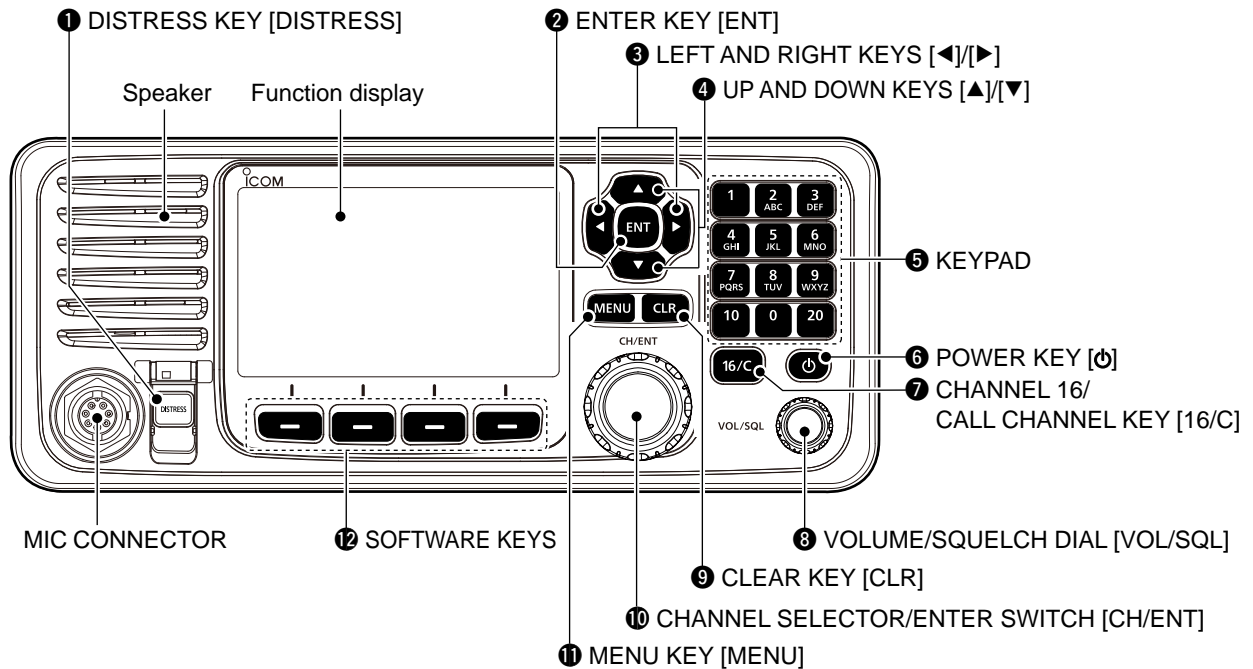

**1 DISTRESS KEY [DISTRESS]** (p. 31)

Hold down for 3 seconds to transmit a Distress call.

**2 ENTER KEY [ENT]**

Push to set the entered data, selected item, and so on.

**3 LEFT AND RIGHT KEYS [◀]/[▶]**

- Push to scroll the Software Key functions. (p. 5)
- In the character or number entry mode, push to select a character or number in the keypad. (p. 20)

**4 UP AND DOWN/CHANNEL SELECT KEYS [▲]/[▼]**

- Push to select an operating channel, (p. 14), Menu items, Menu settings, (p. 13) and so on.
- While scanning, push to check the Favorite channels, change the scanning direction or manually resume a scan. (p. 23)

**5 KEYPAD**

Push to enter numbers, letters or symbols.

For channel number entry, see page 14.

For channel name entry, see page 20

**6 POWER KEY [⏻]**

Hold down for 1 second to turn the transceiver ON or OFF.

**7 CHANNEL 16/CALL CHANNEL KEY [16/C]**

- Push to select Channel 16. (p. 14)
- Hold down for 1 second to select the Call channel. (p. 14)
  - “CALL” is displayed when the Call channel is selected.

**8 VOLUME/SQUELCH DIAL [VOL/SQL]** (p. 18)

- Rotate to adjust the volume level.
- Push once or twice to display the Volume or Squelch Setting screen, and then rotate to adjust the volume or squelch level.

**9 CLEAR KEY [CLR]**

Push to cancel the entered data, or to return to the previous screen.

**10 CHANNEL SELECTOR/ENTER SWITCH [CH/ENT]**

- Rotate to select an operating channel (p. 14), Menu items or Menu settings (p. 13).
- Push to set the entered data, or selected item.

**11 MENU KEY [MENU]**

Push to enter or exit the Menu screen. (p. 13)

---

## 2 PANEL DESCRIPTION

### ■ Front panel (Continued)

#### ⑫ SOFTWARE KEYS (p. 5)

You can use various key functions that are assigned to the Software Keys, as described below.

#### **Compose Distress** (p. 31)

---

Push to display the COMPOSE DISTRESS screen.

#### **Compose Other** (p. 37)

---

Push to display the COMPOSE NON-DISTRESS screen.

#### **Unread List**

---

When the transceiver has unread DSC calls, push to enter the Unread List.

- ① Displayed only when "Single" is selected in the DSC procedure menu. (p. 64)

#### **Task List** (p. 30)

(For only the USA version.)

---

When the transceiver has any task, push to enter the Task List.

- ① Displayed only when "Multiple" is selected in the DSC procedure menu. (p. 64)

#### **Scan** (p. 22)

(Except for the Dutch version.)

---

Push to start or stop a Normal or Priority scan.

#### **Dualwatch/Tri-watch [DW/TW]** (p. 24)

(Except for the Dutch version.)

---

Push to start or stop the Dualwatch or Tri-watch.

#### **AIS** (p. 74)

---

Push to display the AIS plotter on the left side of the display.

- ① An AIS receiver may not be installed, depending on the transceiver version.

#### **Channel/ Weather [CH/WX]** (p. 16)

(For only the USA version.)

---

Push to select either the regular channels or the Weather channels.

#### **Channel [CHAN]** (p. 14)

(For only the versions except the USA version.)

---

Push to enter the regular channel selection mode.

#### **High/Low [HI/LO]** (p. 18)

---

Push to set the output power level to high or low.

- ① Some channels are set to only low power.

#### **Voice Scrambler** (p. 71)

---

Push to set the Voice Scrambler function.

- ① This function is displayed only when the voice scrambler unit is installed.

**RX Play** (p. 72)

Push to play recorded audio.

**RX Hailer** (p. 68)

Push to turn the RX Hailer mode ON or OFF.

**LO/DX**

(For only the USA version.)

Push to turn the Attenuator function ON or OFF.

① The “LOCAL” icon is displayed when the Attenuator function is ON.

**Favorite channel [Favorite]**

Push to set or clear the displayed channel as a Favorite channel. (p. 14)

**Channel Name** (p. 20)

Push to display the CHANNEL NAME screen.

**Backlight** (p. 5)

Push to open the Backlight Settings window.

**DSC Log** (p. 58)

Push to display the RECEIVED CALL LOG screen.

■ **Software Key function**

The transceiver has Software Keys for various functions. The key function is displayed above the Software Key.

◇ **Selecting the Software Key function**

When “◀” or “▶” is displayed beside the key icon, pushing [◀] or [▶] scrolls the Software Key functions. When you push [◀] or [▶] once, 4 functions scroll together.

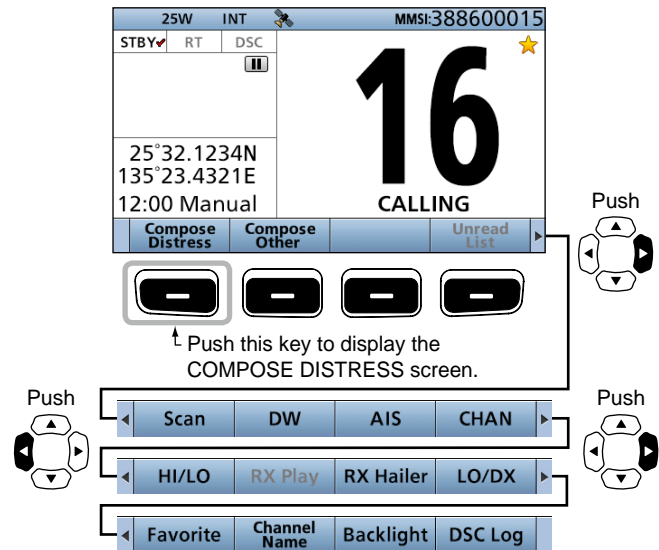

\* The key functions may differ, depending on the transceiver version.

## 2 PANEL DESCRIPTION

### ■ Speaker Microphone

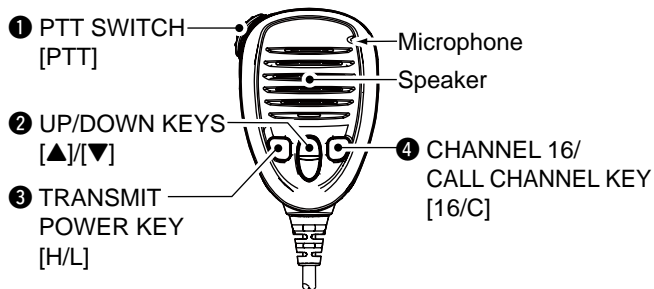

- 1 **PTT SWITCH [PTT]** (p. 18)  
Hold down to transmit, release to receive.
- 2 **UP/DOWN KEYS [▲]/[▼]** (p. 18)  
Push to select the Favorite channels, change scanning direction or manually resume a scan.
  - ① When the “FAV on MIC” item is set to “OFF,” you can select all channels. (p. 18)
- 3 **TRANSMIT POWER KEY [H/L]**
  - Push to set the power level to high or low.
    - ① Some channels are set to only low power.
  - While holding down this key, turn ON the transceiver to turn the Microphone Lock function ON or OFF. (p. 17)
- 4 **CHANNEL 16/CALL CHANNEL KEY [16/C]** (p. 14)
  - Push to select Channel 16.
  - Hold down for 1 second to select the Call channel.
    - The “CALL” icon is displayed.

### ■ Function display (Main screen)

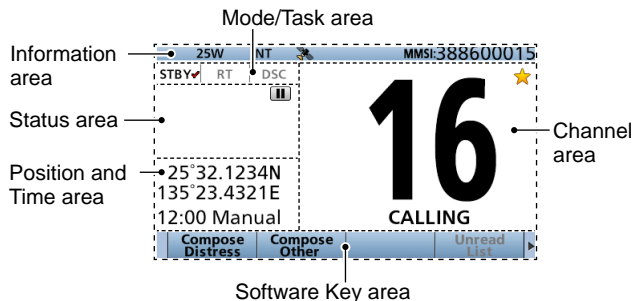

#### ◇ Mode/Task area



The current mode is displayed in the Mode and Task area.

Indicator	Description
	Displayed while in the Standby mode.
	Displayed while in the Radio Telephone (RT) mode. <ul style="list-style-type: none"> <li>① “RT” is displayed when the RT mode task is activated.</li> <li>① Returns to the Standby mode if no operation occurs during the preset period of time. (p. 6)</li> </ul>
	Displayed after making or receiving a DSC call.
	<ul style="list-style-type: none"> <li>① If the transceiver is in the Multiple Task mode, the number of DSC tasks is displayed by the indicator.</li> </ul>



◇ **Channel area**

The selected operating channel number, channel name, and the following indicators are displayed in the Channel area.

Indicator	Description
	Displayed when a Favorite channel is selected.
<b>CALL</b>	Displayed when the Call channel is selected by holding down [16/C] for 1 second.
<b>DUP</b>	Displayed when a Duplex channel is selected.
	Displayed when the battery voltage is low.

◇ **Position and Time area**

**POSITION AREA**

The current position is displayed when valid GPS data is received, or you manually enter your position.

Indicator	Description
<b>NO POSITION</b>	Displayed when a GPS antenna is not connected or your position has not been manually entered.
<b>??</b>	Blinks every 2 seconds instead of your position when the GPS position is invalid. ① The last position is held for only 23.5 hours. After that, "NO POSITION" will be displayed.
	Blinks every 2 seconds instead of the position after 4 hours have passed since you manually entered your position. ① The manually entered position is held for only 23.5 hours. After that, "NO POSITION" will be displayed.

**TIME AREA**

The current time is displayed when valid GPS data is received, or manually enter the time.

The date information is displayed when the RMC GPS sentence formats are included in the GPS signal.





Indicator	Description
<b>NO TIME</b>	Displayed when a GPS antenna is not connected or the time has not been manually entered.
<b>Local</b>	Displayed when the offset time is set.
<b>Manual</b>	Displayed when the time was manually entered.
<b>UTC</b>	Displayed when the GGA, GLL or GNS sentences are received from NMEA 0183.
<b>??</b>	Blinks every 2 seconds instead of the time when the GPS current time is invalid. ① After 23.5 hours has passed, "NO TIME" will be displayed.
	Blinks every 2 seconds instead of the time after 4 hours have passed since you manually entered the time. ① The manually entered time is held for only 23.5 hours. After that, "NO TIME" will be displayed.

## 2 PANEL DESCRIPTION

### ■ Function display (Main screen) (Continued)

#### ◇ Status area

The current status is displayed in the Status area.







Indicator	Description
<b>SCAN 16</b>	Displayed during a Priority scan. (p. 23)*
<b>SCAN</b>	Displayed during a Normal scan. (p. 23)*
<b>DUAL 16</b>	Displayed during Dualwatch. (p. 24)*
<b>TRI 16</b>	Displayed during Tri-watch. (p. 24)*
<b>LOCAL</b>	Displayed when the Attenuator function is turned ON. *For only the USA version.
<b>RX</b> 	Displayed when in the RX Hailer mode. (p. 68)
 	• Displayed when recorded audio is played or stopped. (p. 72)
	• Displayed when received audio is recorded. (p. 72)

\*Not usable in Dutch version.

#### ◇ Information area

The MMSI code\* and the following indicators are displayed in the Information area.

\*ATIS code is displayed if only the ATIS code is entered in Dutch and German version.

Indicator	Description
	Displayed when receiving a signal or when the squelch is open.
	Displayed while transmitting.
<b>25W</b>	Displayed when high power is selected.
<b>1W</b>	Displayed when low power is selected.
<b>USA, INT, CAN, WX, ATIS, DSC</b>	<ul style="list-style-type: none"> <li>• Displays the selected channel group. (p. 15)</li> <li>• “WX” is displayed when the weather channel is selected.</li> </ul>
	Displayed when the transceiver receives valid position and time data. Blinks when invalid GPS data is being received.
	<ul style="list-style-type: none"> <li>• Displayed when there are unread DSC messages.</li> <li>• Blinks when a DSC message is received.</li> </ul>
	Displayed when the “CH Auto Switch” in DSC Settings is set to an option except “Accept.”
	Displayed when the Auto Foghorn function is activated. (p. 69)

## ■ Entering the MMSI code

First, you must enter the 9 digit MMSI (Maritime Mobile Service Identity: DSC self ID) code at power ON.

**NOTE:** You can enter this initial code ONLY ONCE. After entry, only your dealer or distributor can change it. If your MMSI code has already been entered, this entry is not necessary.

1. Hold down [0] for 1 second to turn ON the transceiver.
  - Three short beeps sound.
  - “Push [ENT] to Register Your MMSI” is displayed.
2. Push [ENT] to enter the MMSI code entry mode.

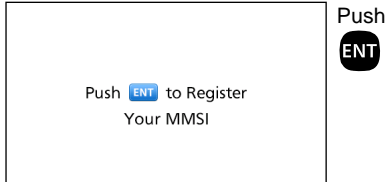

- Push [CLR] to cancel the entry. In that case, the transceiver displays “Push [ENT] to Register Your MMSI” again.

3. Enter your 9 digit MMSI code.



4. After entering the 9th digit, push [Finish] to set the ID.



5. Reenter your MMSI code to confirm.



6. After entering the 9th digit, push [Finish] to register the ID.



- When you successfully enter your MMSI code, the following screen is displayed.

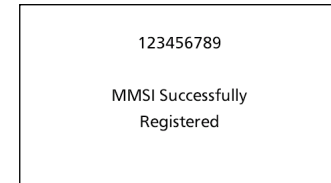

- After that, the Main screen is displayed. The registered MMSI code is displayed at the top of the screen.

### 3 PREPARATION

## ■ Entering the ATIS code (For Dutch and German versions)

The Automatic Transmitter Identification System (ATIS) ID consists of 10 digits. You can enter the ID in the “ATIS ID Input” item on the Menu screen.

You can enter this ID ONLY ONCE. After entry, only your dealer or distributor can change it. If your ATIS ID has already been entered, this entry is not necessary.

1. Push [MENU].
2. Select “ATIS ID Input,” then push [ENT].
3. Enter a 10 digit ATIS code.

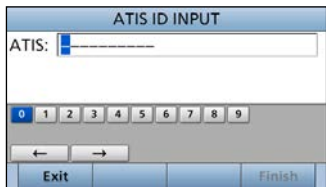

Push  
1 2 3  
4 5 6  
7 8 9  
10 0 20  
+  
Rotate  
CH/ENT

4. After entering the 10th digit, push [Finish]  to set the ID.

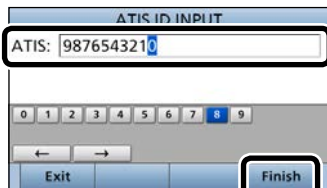

Push



5. Reenter your ATIS code to confirm.

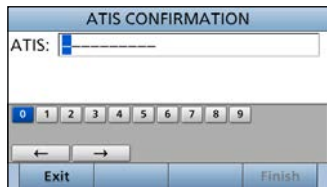

Push  
1 2 3  
4 5 6  
7 8 9  
10 0 20  
+  
Rotate  
CH/ENT

6. After entering the 10th digit, push [Finish]  to register the ID.

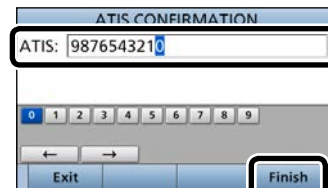

Push



- When you successfully enter your ATIS code, the following screen is displayed.



You can use the Menu screen to set infrequently changed values or function settings.

## ■ Construction

The Menu screen is constructed in a tree structure. You can go to the next tree level with [ENT], or go back a level with [CLR].  
① See page viii for details.

To select an item, rotate [CH/ENT].

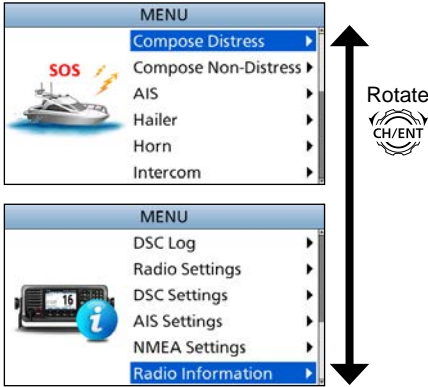

### • Compose Distress (p. 31)

Nature of Distress	Select a Nature of Distress option.
Position	
• Latitude	Displays latitude data.
• Longitude	Displays longitude data.
• UTC	Displays UTC offset data.

### • Compose Non-Distress (p. 37)

Message Type	Select a Message Type option.
Address*1	Enter a destination address.
Position*1	
• Latitude*1	Displays latitude data.
• Longitude*1	Displays longitude data.
• UTC*1	Displays UTC offset data.
Category	Select a Category option.
Mode*1	Displays a Mode.
Channel*1	Select an Intership channel.

### • AIS (p. 74)

Displays the AIS plotter.

### • Hailer (p. 68)

Displays the Hailer function screen.

### • Horn (p. 69)

Manual Horn	Hold down [Horn]  to sound a horn.
Auto Foghorn	Select the automatic foghorn pattern.
Frequency	Select the foghorn's audio frequency.

### • Intercom\*2 (p. 67)

RADIO	Displays the transceiver's name.
SUB UNIT 1, 2, 3	Displays name of the unit that are connected for the Intercom function.

### • GPS Information (p. 85)

Displays the GPS information.

### • AquaQuake (p. 21)

Displays the AquaQuake function screen.

### • Configuration

Key Beep	Turn the Key Beep function ON or OFF.
Key Assignment	Select the items to the assignable keys.
UTC Offset	Set the UTC Offset.
Inactivity Timer	
• Not DSC Related	Set the inactivity timer for not DSC related calls.
• DSC Related	Set the inactivity timer for DSC related calls.
• Distress Related	Set the inactivity timer for Distress related calls.
• RT Related	Set the inactivity timer for the Radio Telephone mode.
Speaker	
• Internal	The audio is heard from the internal speaker.
• Int. and ext.	The audio is heard from both the internal speaker and the external speaker.

\*1 May not be displayed, depending on the message type.  
\*2 Displayed when the optional command microphone or command head is connected to the transceiver.

## 4 MENU SCREEN

### ■ Construction (Continued)

Noise Cancel	
• RX	Set the reduction level of the Noise Cancel function.
• TX	Turn the Noise Cancel function for the transmit signal ON or OFF.
Power SW from Sub Unit	
• All Units	When you turn OFF the command head, the transceiver is turned OFF at the same time.
• Own Unit	The transceiver is not turned OFF even if you turned OFF the command microphone.

### • DSC Log (p. 58)

Received Call Log	Displays the received call log.
Transmitted Call Log	Displays the transmitted call log.

### • Radio Settings (p. 88)

Scan Type*4	Select a Scan Type from Normal Scan or Priority Scan.
Scan Timer*4	Turn the Scan Timer function ON or OFF.
Dual/Tri-Watch*4	Select the Dualwatch or Tri-watch function.
Channel Group	Select a channel group.
Call Channel	Set the Call channel.

\*1 May not be displayed, depending on the version.

\*2 Not displayed, when valid GPS data is received.

\*3 Displayed only when the voice scrambler unit is installed. \*4 Not usable in Dutch version.

WX Alert*1	Turn the Weather Alert function ON or OFF.
Voice Scrambler*3	Set the Voice Scrambler code.
Voice Record	Select whether or not to automatically record the voice audio.
FAV Settings	Set the Favorite channel settings.
FAV on MIC	Turn the FAV on MIC function ON or OFF.

### • DSC Settings (p. 60)

Position Input*2	Enter your position.
Individual ID	Enter an Individual ID.
Group ID	Enter a Group ID.
Auto ACK	Select whether or not to automatically transmit an Acknowledgement after receiving each type of call.
CH Auto Switch	Select whether or to automatically select the channel that the DSC call is received on, when received.
DSC Data Output	Select a DSC Data Output option.
Alarm Status	
• Safety	Turn the Alarm Status for Safety ON or OFF.
• Routine	Turn the Alarm Status for Routine ON or OFF.
• Warning	Turn the Alarm Status for Warning ON or OFF.

• Self-Terminate	Turn the Alarm Status for Self-Terminate ON or OFF.
• Discrete	Turn the Alarm Status for Discrete ON or OFF.
CH 70 SQL Level	Select the Channel 70 squelch level.
Self Check Test Procedure*1	Starts the self check Test. Select the Single task mode or Multiple task mode.

### • AIS Settings (p. 80)

North Up/COG Up	Select the display type for AIS plotter.
CPA/TCPA	Edit the alarm settings for AIS receiver.
ID Blocking	Enter the vessel's or your transponder ID to block.

### • NMEA Settings (p. 91)

NMEA0183	
• Port 1, Port 2	Select the data transfer speed to receive and transmit data from external devices.
NMEA2000	
• GPS, AIS	Select the sensors in NMEA 2000 network which sends GPS or AIS data to the transceiver.

### • Radio Information (p. 93)

Displays your transceiver's Serial number, software version, GPS module version, and so on.

## ■ Selecting a Menu item

Follow the procedures described below to select a Menu item.

Example: Set the Tri-watch function.

1. Push [MENU] to display the MENU screen.
2. Rotate [CH/ENT] to select “Radio Settings,” then push [ENT].



3. Rotate [CH/ENT] to select “Dual/Tri-Watch,” then push [ENT].

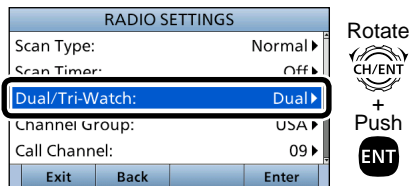

4. Rotate [CH/ENT] to select “Tri-Watch,” and then push [ENT].



- Sets the Tri-watch function, and then goes back to the RADIO SETTINGS screen, after pushing [ENT].

5. Push [MENU] to return to the Main screen.

## ■ Selecting a channel

### ◇ Selecting a regular channel

- Rotate [CH/ENT].
- Push [▲] or [▼].
- Push the keypad to directly enter the channel number.

(Example: Selecting Channel 22)

Push [2 ABC] → [2 ABC].



Push  
 1 2 3  
 4 5 6  
 7 8 9  
 10 0 20  
 twice

### ◇ Selecting Channel 16

Channel 16 is the distress and safety channel. It is used for establishing initial contact with a station, and for emergency communications.

While standing by, you must monitor Channel 16.

- Push [16/C].

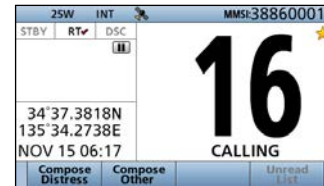

### ◇ Selecting Call channel

You have a leisure use Call channel for quick recall. To set your most used channel, see page 17.

The default Call channel differs, depending on the transceiver version.

- Hold down [16/C] for 1 second.



Displayed



### ◇ Selecting a channel group

Channel Groups are preset into your transceiver. You can select the Channel Group between USA, International, Canadian, DSC, and ATIS, depending on the transceiver version.

Version	Preset Channel Group				
	USA	INT	CAN	DSC	ATIS
USA	✓	✓	✓		
UK	✓	✓			
European		✓			
Dutch		✓			✓
German		✓		✓	✓
Chinese	✓	✓	✓		

1. Push [MENU].
  - The “MENU” screen is displayed.
2. Rotate [CH/ENT] to select “Radio Settings,” then push [ENT].

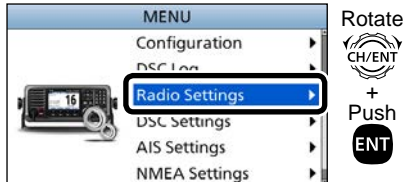

3. Rotate [CH/ENT] to select “Channel Group,” then push [ENT].

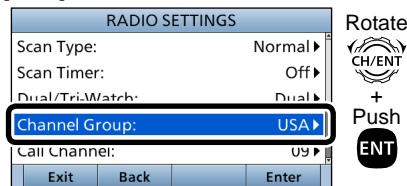

4. Rotate [CH/ENT] to select the Channel Group, then push [ENT].



5. Push [MENU] to return to the Main screen.
  - The selected Channel Group’s icon is displayed on the Main screen.



## 5 BASIC OPERATION

### ◇ Weather channels and Weather Alert function

For the USA version, the transceiver has 10 preset Weather channels. You can use these channels to monitor broadcasts from the National Oceanographic and Atmospheric Administration (NOAA). The transceiver automatically detects a Weather alert tone on the selected weather channel, or while scanning.

#### Selecting a Weather channel

1. Push [◀] or [▶] until “CH/WX” is displayed in the Software Key area.
2. Push [CH/WX] .



Push 

- “WX” is displayed instead of the Channel Group icon.
3. Rotate [CH/ENT] to select a Weather channel.

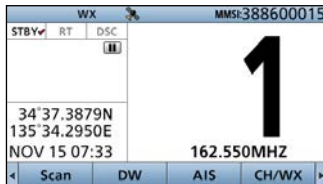

Rotate



#### Setting the Weather Alert function

1. Push [MENU].
  - The “MENU” screen is displayed.
2. Rotate [CH/ENT] to select “Radio Settings,” then push [ENT].
3. Rotate [CH/ENT] to select “WX Alert,” then push [ENT].

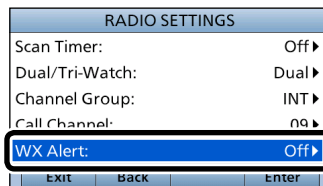

Rotate



+  
Push



- The “WX ALERT” screen is displayed.
4. Rotate [CH/ENT] to select “On with Scan” or “On,” then push [ENT].
  5. Push [MENU] to return to the Main screen.
    - “” is displayed next to “WX” on the Main screen.

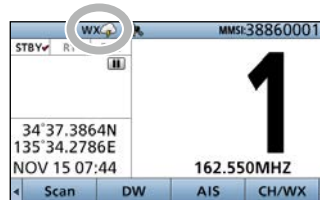

## ■ Setting the Call channel

By default, a Call channel is set in each Channel Group. You can set the Call channel with your most often-used channel for quick recall.

1. Push [MENU].
  - The "MENU" screen is displayed.
2. Rotate [CH/ENT] to select "Radio Settings," then push [ENT].
3. Rotate [CH/ENT] to select "Call Channel," then push [ENT].

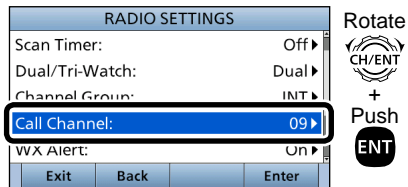

- The "CALL CHANNEL" screen is displayed.
4. Rotate [CH/ENT] to select a channel to be set as the Call channel, then push [ENT].
  5. Push [MENU] to return to the Main screen.

**TIP:** To confirm that your setting is correctly set, hold down [16/C] for 1 second. (p. 14)

## ■ Microphone Lock function

The Microphone Lock function electrically locks [▲], [▼], [16/C] and [H/L] on the supplied microphone. This prevents accidental channel changes or function access.

While holding down [H/L] on the microphone, hold down [⏻] for 1 second to turn ON the transceiver.

- The Microphone Lock function is turned ON or OFF.

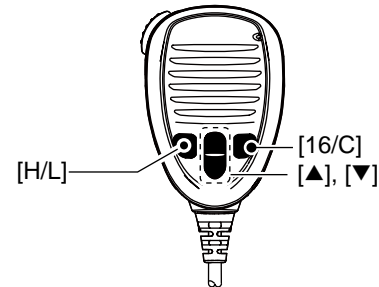

## 5 BASIC OPERATION

### ■ Receiving and transmitting

**CAUTION: DO NOT** transmit without an antenna. It will damage the transceiver.

1. Hold down [⏻] for 1 second to turn ON the transceiver.  
① If no MMSI code is entered, "Push [ENT] to Register Your MMSI" is displayed. (p. 9)
2. Rotate [VOL/SQL] to adjust the audio level.
3. Push [VOL/SQL] once or twice to open the "SQL Setting" window, then rotate [VOL/SQL] to adjust the squelch level until the noise just disappears.
4. Select a channel. (p. 14)

#### ① Information

- When receiving a signal, "BUSY" is displayed.
  - You can use Channel 70 only for Digital Selective Calling (DSC) transmissions.
  - When the "FAV on MIC" item is set to "OFF," you can select all channels using the [▲] or [▼] keys on the microphone. (p. 6)
5. Push [◀] or [▶] until "HI/LO" is displayed in the Software Key area.
  6. Push [HI/LO]  to select an output power high or low.

#### ① Information

- "25W" is displayed when high power is selected. Choose high power for longer distance communications.
  - "1W" is displayed when low power is selected. Choose low power for short range communications.
  - Some channels are restricted to low power.
7. Hold down [PTT], and speak at your normal voice level.  
• "TX" is displayed.
  8. Release [PTT] to return to receive.

**IMPORTANT:** To maximize the readability of your transmitted signal at a receiver station, pause a second after pushing [PTT], and then hold the microphone 5 to 10 cm from your mouth and speak at your normal voice level.

#### **NOTE for the Time-out Timer (TOT) function:**

The TOT function inhibits continuous transmission beyond a preset time period after the transmission starts. 10 seconds before transmission is cut off, a beep sounds to indicate the transmission will be cut off, and "TOT" blinks in the channel name field. After it is cut OFF, "TIME OUT" is displayed for 10 seconds. And you cannot transmit until "TIME OUT" disappears.

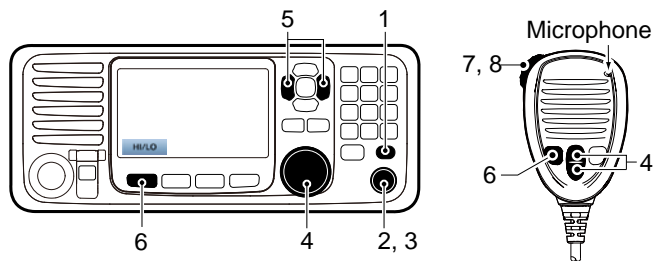

## ■ Backlight function

The function display and keys can be backlit for better visibility under low light conditions. And, you can set the Backlight mode to Day mode or Night mode.

The Day mode is for the daytime operation, and the screen items are in color.

The Night mode is for the nighttime operation, and the screen items are in black and red.

1. Push [◀] or [▶] until “Backlight” is displayed in the Software Key area.
2. Push [Backlight]  to open the “Backlight Settings” window.



**TIP:** In the “Backlight Setting” window, if you push no key for about 5 seconds, the transceiver automatically returns to the Normal operation mode.

3. Push [▲] or [▼] to select “Day Mode” or “Night Mode.”



4. Rotate [CH/ENT] to adjust the backlight level, then push [ENT].

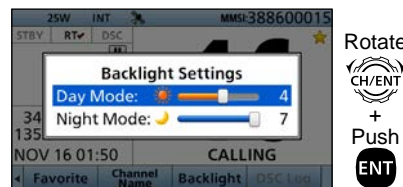

- ① The backlight level is adjustable in 7 levels and “OFF.”\*\*  
 \*\*“OFF” is selectable only for the Day mode.

## 5 BASIC OPERATION

### ■ Entering a Channel name

You can rename each channel with a unique alphanumeric ID of up to 10 characters. This may be helpful to indicate the frequency's use.

1. Cancel the Dualwatch, Tri-watch or Scan function, if activated.
2. Select a channel. (p. 17)
3. Push [◀] or [▶] until "Channel Name" is displayed in the Software Key area.
4. Push [Channel Name] . Push

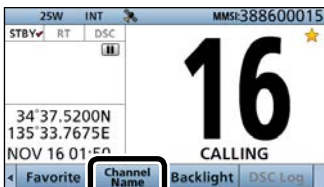

5. Enter a channel name.



Push





+  
Rotate



#### ① Information

- You can enter the following characters by pushing the keypad one or more times.

KEY	ENTRY	KEY	ENTRY
[1]	1	[6]	6 M N O
[2]	2 A B C	[7]	7 P Q R S
[3]	3 D E F	[8]	8 T U V
[4]	4 G H I	[9]	9 W X Y Z
[5]	5 J K L	[0]	0 . (period)

- To move the cursor, rotate [CH/ENT].
  - To enter a symbol, push [!\$?] . And then push [▲], [▼], [◀], or [▶] to select the character, then push [ENT].
  - To correct an entry, move the cursor to the character, and then enter the correct character.
6. After entering, push [Finish]  to return to the Main screen.



## ■ Using the AquaQuake water draining function

Water in the speaker grill may muffle the sound coming from the speaker. The AquaQuake Water Draining function removes water from the speaker grill by vibrating the speaker.

1. Push [MENU].
  - The "MENU" screen is displayed.
2. Rotate [CH/ENT] to select "AquaQuake," then push [ENT].
3. Hold down [Aqua Quake]  until all water is removed from the speaker grill.



- A low frequency vibration beep sounds to drain the water, regardless of the volume level setting.
  - ① This function is activated for a maximum of 10 seconds, even if you continue to hold down the Software Key.
4. Push [MENU] to return to the Main screen.

# 6

## SCAN OPERATION (Except for the Dutch version)

### ■ Scan types

Except for the Dutch version, you can find ongoing calls by scanning the Favorite channels without rotating [CH/ENT].

The IC-M605 and IC-M605EURO have two scan types.

- Priority scan
- Normal scan

#### Before you start a scan:

- Set the channels you want to scan as Favorite channels. (Scans only Favorite channels.) (p. 23)
- Set the scan type to "Normal" or "Priority." (p. 88)

#### PRIORITY SCAN

A Priority scan sequentially scans all Favorite channels while monitoring Channel 16.

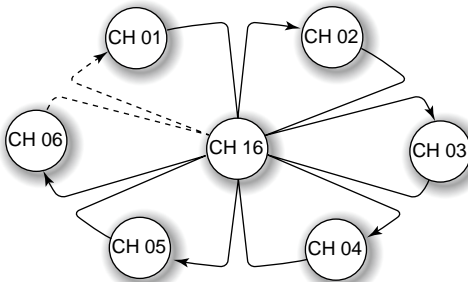

#### When a signal is received:

- **On Channel 16**  
The scan pauses until the signal on Channel 16 disappears.
- **On a channel other than Channel 16:**  
The scan switches to Dualwatch, until the signal disappears.

#### NORMAL SCAN

A Normal scan sequentially scans all Favorite channels. However, the scan does not check Channel 16 unless it is set as a Favorite channel.

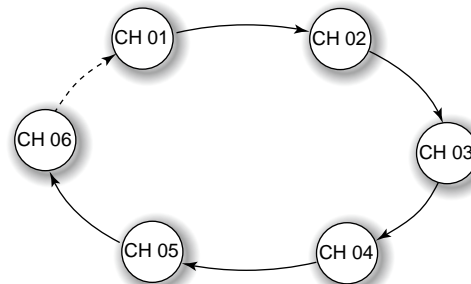



## Favorite channels

You can quickly recall often-used channels by setting them as Favorite channels.

All channels are set as Favorite channels by default.

### ◇ Setting

1. Rotate [CH/ENT] to select a channel.
2. Push [Favorite]  to set the channel as a Favorite channel.
  - “★” is displayed.

### ◇ Selecting

- Push [▲] or [▼] on the microphone.
  - Non-Favorite channels are skipped and not displayed.
  - When the “FAV on MIC” item is set to “OFF,” you can select all channels. (p. 90)



**TIP:** You can select all channels by rotating [CH/ENT] or pushing [▲] or [▼] on the transceiver. (p. 14)

### ◇ Clearing

1. Select a Favorite channel to clear.
2. Push [Favorite]  to clear the channel as the Favorite channel.
  - “★” disappears.

**TIP:** You can clear all Favorite channels in the Menu screen. (p. 90)

## Starting a scan

1. Push [Scan]  to start a scan.
  - During a Priority scan, “SCAN 16” is displayed.
  - During a Normal scan, “SCAN” is displayed.
2. Push [Scan]  again to cancel the scan.
  - “SCAN 16” or “SCAN” disappears.

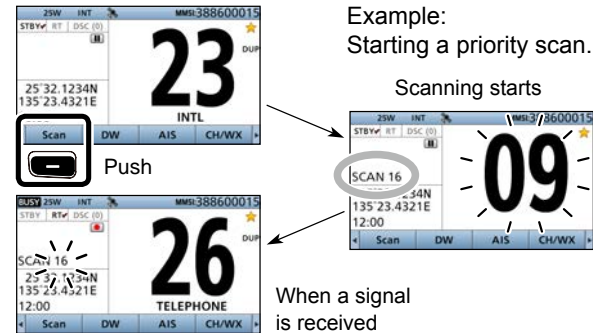

### NOTE:

- When a signal is received, the scan pauses until the signal disappears, or resumes after pausing for 5 seconds, depending on the “Scan Timer” setting. (p. 88)
- You can check the scanning channel, change the scan direction, or manually resume the scan by pushing [▲] or [▼] on either the transceiver or the microphone.
- A beep tone sounds and “16” blinks when a signal is received on Channel 16 during a Priority scan.
- In order to properly receive signals, you must adjust the squelch to the proper level. (p. 18)

## ■ Description

Dualwatch and Tri-watch are convenient for monitoring Channel 16 while you are listening on another channel.

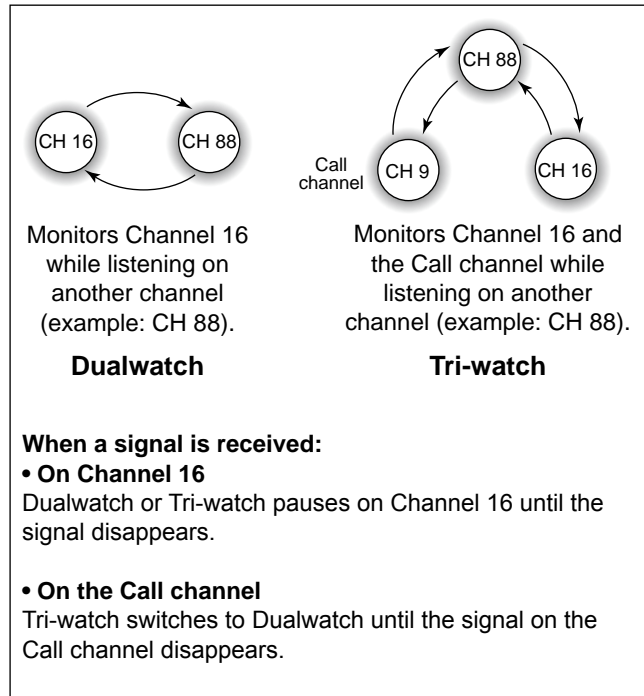

## ■ Operation

1. Select Dualwatch or Tri-watch in the Menu screen. (p. 89)
2. Select a channel. (p. 14)
3. Push [DW] or [TW] to start Dualwatch or Tri-watch.
  - During Dualwatch, "DUAL 16" is displayed.
  - During Tri-watch, "TRI 16" is displayed.
  - A beep tone sounds and "16" starts to blink when a signal is received on Channel 16.
4. Push [DW] or [TW] again to cancel Dualwatch or Tri-watch.

Example: Operating Dualwatch on Channel 07.



## ■ DSC address ID

You can enter a total of 100 DSC address IDs (Individual ID: 75, Group ID: 25), and assign a name of up to 10 characters to each ID.

### ◇ Entering an Individual ID

1. Push [MENU].
2. Select "Individual ID," then push [ENT].  
(DSC Settings > Individual ID)
3. Push [Add] .

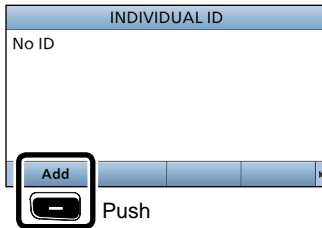

4. Enter a 9 digit Individual ID.

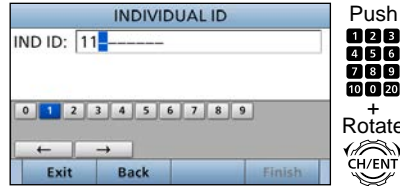

**TIP:** You must set the first digit for the Individual ID to between '1' and '9.'

- A '0' in the first digit is used for a Group ID.
- A '0' in the first two digits is used for any Coast station ID.

5. After entering all 9 digits, push [Finish] .
6. Enter the ID name.

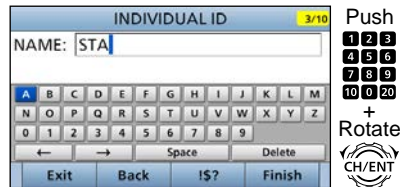

① See page 20 for text entry details.

7. After entering, push [ENT].

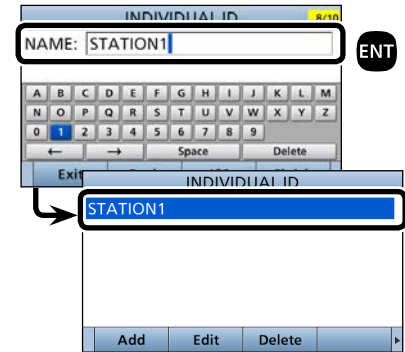

- The entered Individual ID and name are added to the ID list.
8. Push [MENU] to return to the Main screen.

7  
8

# 8 DSC OPERATION

## ◇ Entering the Group ID

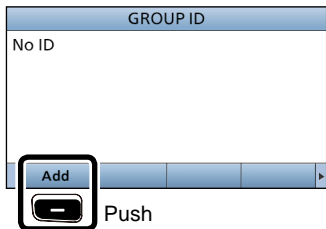

1. Push [MENU].
2. Select “Group ID,” then push [ENT].  
(DSC Settings > **Group ID**)
3. Push [Add] .



Push

4. Enter a 9 digit Group ID.



Push  
  
 +  
 Rotate  

**TIP:** You must set the first digit for a Group ID to '0.'

- The first digit must be set to between '1' and '9' for an Individual ID.
- A '0' in the first two digits is used for any Coast station ID.

5. After entering all 9 digits, push [Finish] .
6. Enter the ID name.



Push  
  
 +  
 Rotate  

① See page 20 for text entry details.

7. After entering, push [Finish] .

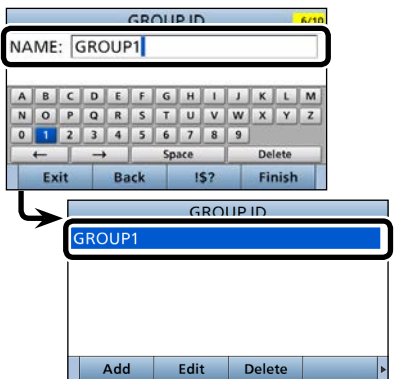

• The entered Group ID and name are added to the ID list.

8. Push [MENU] to return to the Main screen.

## ◇ Deleting an entered ID

1. Push [MENU].
2. Select “Individual ID” or “Group ID,” then push [ENT].  
(DSC Settings > **Individual ID**)  
(DSC Settings > **Group ID**)
3. Rotate [CH/ENT] to select the ID to delete.

4. Push [Delete] .

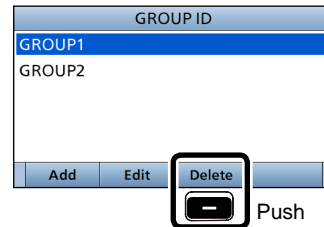

Push

• The exit confirmation dialog is displayed.

5. Push [OK] .
6. Push [MENU] to return to the Main screen.

## ■ Entering the position and time

A Distress call should include the ship's position and time.

When a GPS receiver compatible with the NMEA 0183 format is connected, position and UTC time are automatically included.

If no GPS data is received, you should manually enter your position (latitude and longitude) and Universal Time Coordinated (UTC) time.

- Manual entry is disabled when a valid GPS data is received.
- Manually entered position and time are valid for only 23.5 hours.

1. Push [MENU].
2. Select "Position Input," then push [ENT].  
(DSC Settings > **Position Input**)

3. Enter your position's latitude.

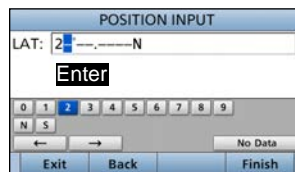

Push  
1 2 3  
4 5 6  
7 8 9  
10 0 20

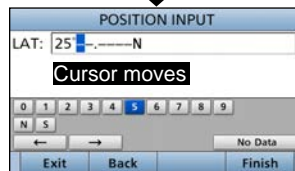

Rotate  
CH/ENT

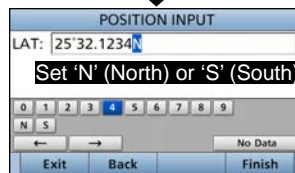

Push  
1 2 3  
4 5 6  
7 8 9  
10 0 20  
(any key)

To select 'N' (North latitude) or 'S' (South latitude), push any keypad key when the cursor is on the 'N' or 'S' position.

4. After entering, push [Finish]

5. Enter your position's longitude.

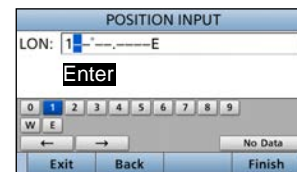

Push  
1 2 3  
4 5 6  
7 8 9  
10 0 20

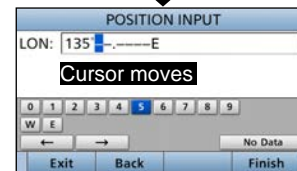

Rotate  
CH/ENT

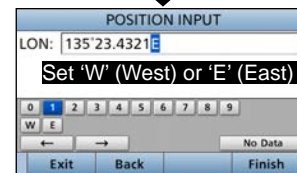

Push  
1 2 3  
4 5 6  
7 8 9  
10 0 20  
(any key)

① To select W (West longitude) or E (East longitude), push any keypad key when the cursor is on the 'W' or 'E' position.

6. After entering, push [Finish]

## 8 DSC OPERATION

### ■ Entering the position and time (Continued)

7. Enter your UTC time.

Push  
 1 2 3  
 4 5 6  
 7 8 9  
 10 0 20

Rotate  
 CH/ENT

Push  
 1 2 3  
 4 5 6  
 7 8 9  
 10 0 20  
 (any key)

8. After entering, push [Finish] .
  - The DSC SETTINGS screen is displayed.
9. Push [MENU] to return to the Main screen.

When position and time data are set, Latitude, Longitude and UTC time are displayed.



- Latitude: 25°32.1234N
- Longitude: 135°23.4321E
- UTC time: 12:00

When no position and time data are set, "No Position" and "No Time" are displayed.

#### NOTE:

##### While entering:

- To move the cursor:  
Rotate [CH/ENT].
- To correct the entry:  
Move the cursor to the character, then enter the correct character.
- To clear the entry:  
Push [▲], [▼], [◀], or [▶] to select "No Data," then push [ENT].  
When the following screen is displayed, push [ENT].

- To return to the Main screen:  
Push [Exit] .
- To go back to the previous screen:  
Push [Back] .

## ■ DSC Task mode (Single)

After sending or receiving a DSC call, the transceiver enters the DSC Task mode.

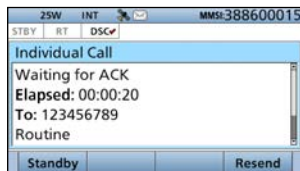

(Example: After transmitting an Individual call) In the Task mode, you can resend the call, or send an acknowledgement to the caller station, and so on.

**NOTE:** The Task mode has a Time-out Timer (TOT) function. When you push no key for a preset period of time, the transceiver automatically exits the Task mode. A count down alarm sounds 10 seconds before the TOT activates. No count down alarm sounds before Radio Telephone TOT activates. You can set the TOT function in the INACTIVITY TIMER menu. (p. 86)

**The default settings of the TOT function:**

- Distress call: OFF
- Non-Distress call: 15 minutes

### ◇ Software key functions

When entering the Task mode, the following functions are displayed first.

FUNCTION	DESCRIPTION
Standby	Push to delete the task and returns to the Main screen.
Resend	Push to resend the call.



The following functions may be displayed, depending on the call type.

FUNCTION	DESCRIPTION
Cancel	Push to send a Cancel call.
Pause	Push to pause the 'Call repeat' mode, or pause the countdown.
Resume	Push to resume the countdown.
Finish	Push to exit the Distress cancel statement screen.
History	Push to display the Distress call history screen.
ACK/ACK (able)	Push to send an acknowledgment without any changes.
ACK (Unable)	Push to send an acknowledgment, but you cannot make a communication.
ACK (New CH)	Send an acknowledgment. You can specify the Voice Communication channel.

### ◇ Unread List

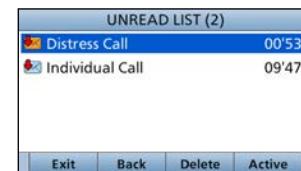
If the transceiver has unread DSC calls, you can enter the UNREAD LIST menu by pushing [Unread List] .



- ① Push [Active]  to enter the task mode.
- ① Push [Info]  to display the detail of selected task.

## ■ DSC Task mode (Multiple)

(For only the USA version, depending on the presetting.)

If the Multiple task is enabled, the transceiver can hold up to 7 tasks. Therefore, you can make more than 2 DSC calls in parallel. The number of task is displayed in the Task area.



(Example: After transmitting a Group call)

To use the Multiple task mode, select "Multiple" in the PROCEDURE menu (p. 64).

**NOTE:** The Task mode has a Time-out Timer (TOT) function. When you push no key for a preset period of time, the transceiver automatically exits the Task mode.

A count down alarm sounds 10 seconds before the TOT activates.

No count down alarm sounds before Radio Telephone TOT activates. You can set the TOT function in the INACTIVITY TIMER menu. (p. 86)

**The default settings of the TOT function:**

- Distress call: OFF
- Non-Distress call: 15 minutes

### ◇ Software key functions

When entering the Task mode, the following functions are displayed first.

FUNCTION	DESCRIPTION
Standby	Push to hold the task and returns to the Main screen.
Delete	Push to delete the task and display the Task list.
Hold	Push to hold the task and display the Task list.
Task List	Push to display the Task list.
Resend	Push to resend the call.

The following functions may be displayed, depending on the call type.

FUNCTION	DESCRIPTION
Cancel	Push to send a Cancel call.
Pause	Push to pause the 'Call repeat' mode, or pause the countdown.
Resume	Push to resume the countdown.
Finish	Push to exit the Distress cancel statement screen.
History	Push to display the Distress call history screen.

FUNCTION	DESCRIPTION
ACK/ ACK (Able)	Push to send an acknowledgment without any changes.
ACK (Unable)	Push to send an acknowledgment, but you cannot make a communication.
ACK (New CH)	Send an acknowledgment. You can specify the Voice Communication channel.

### ◇ Task List

When the number of task is displayed in the standby mode, you can enter the task mode by pushing [Task List] .

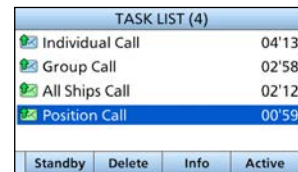

① Push [Info]  to display the details of selected task.



## ■ Sending a Distress call

**NEVER MAKE A DISTRESS CALL IF YOUR SHIP OR A PERSON IS NOT IN AN EMERGENCY. A DISTRESS CALL SHOULD BE MADE ONLY WHEN IMMEDIATE HELP IS NEEDED.**

You should send a Distress call if, in the opinion of the Master, the ship or a person is in distress and requires immediate assistance.

① Emergency channel (Channel 70) is automatically selected to send a Distress call.

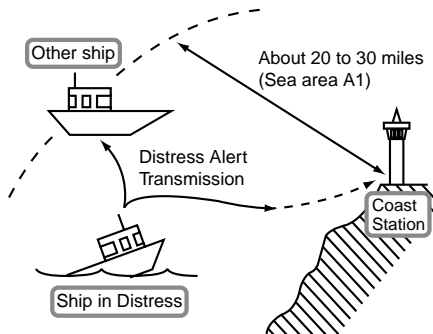

See **NOTE** on page 33 for a Distress call.

**TIP:** If you want to compose a Distress call, see 'Regular call.' (p. 32)

### ◇ Simple call

1. Confirm no Distress call is being received.
2. Lift up the key cover, then hold down [DISTRESS] until "Transmitting" is displayed to send the Distress call.
  - While holding down [DISTRESS], count down beeps sound and both the key and display backlighting blink.

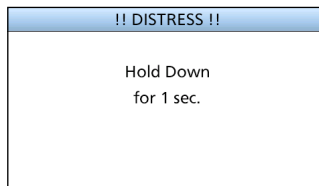

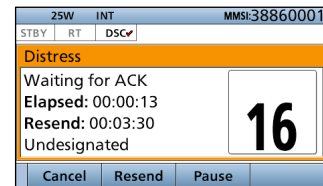

3. After sending, the following screen is displayed.

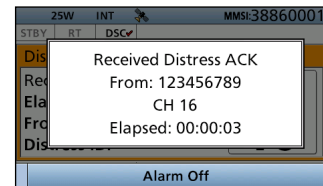

- Channel 16 is automatically selected.
4. When receiving the acknowledgement:
    - Alarm sounds.
    - The following screen is displayed.



5. Push any [Alarm Off] .
6. Push any [Close Call RCVD Window] .
7. Hold down [PTT] to announce your situation.
8. Push [Standby]  to return to the Main screen.

# 8 DSC OPERATION

## ■ Sending a Distress call (Continued)

### ◇ Regular call

You can compose a Distress call.

#### Step 1. Display the COMPOSE DISTRESS screen

1. Push [Compose Distress] 



- ① To display the screen from the Menu screen:  
([MENU] > **Compose Distress**)

#### Step 2. Setting "Nature of Distress"

1. Push [ENT].

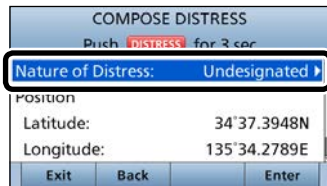

Push 

2. Select the option, then push [ENT].  
(Example: Fire,Explosion)

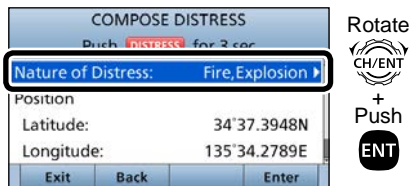

#### Options:

Undesignated, Fire,Explosion, Flooding, Collision, Grounding, Capsizing, Sinking, Adrift, Abandoning Ship, Piracy, and Man Overboard.

- ① The transceiver stores this setting for 30 seconds.

You can skip Step 3 below if your position and time data are valid. In that case, go to Step 4.

#### Step 3. Entering "Position"

1. Select "Position," then push [ENT].
  - The position entry screen is displayed.
2. Enter your position and time data.
  - ① See page 27 for entering details.
3. After entering, push [ENT].

#### Step 4. Sending

1. Lift up the key cover, then hold down [DISTRESS] until "Transmitting" is displayed to send the Distress call.
  - While holding down [DISTRESS], count down beeps sound and both the key and display backlighting blink.

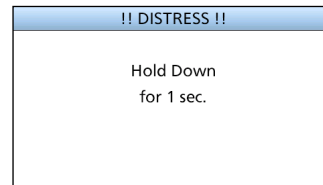

2. After sending, the following screen is displayed.





- Channel 16 is automatically selected.
- ① See page 29 or page 30 for details of the Task mode's software key functions.

### Step 5. Replying

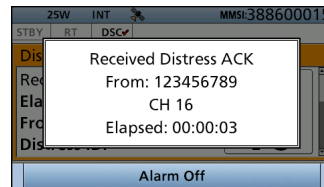
1. When the acknowledgement is received:
  - Alarm sounds.
  - The following screen is displayed.





2. Push any [Alarm Off] .
3. Push any [Close Call RCVD Window] .
4. Hold down [PTT] to announce your situation.
5. Push [Standby]  to return to the Main screen.

### NOTE:

#### Transmitting:

- A distress alert default contains:
  - Nature of distress: Undesignated distress (Simple call) Selected in Step 2 (Regular call)
  - Position information: The latest GPS or manual input position is held for 23.5 hours, or until the power is turned OFF.

#### Waiting for an acknowledgement:

- The transceiver automatically sends a Distress call every 3.5 to 4.5 minutes, until receiving an acknowledgement ('Call repeat' mode), or sending a DSC Cancel call. (p. 35)
- To manually send a Distress Repeat call: Push [Resend] .
- To view the call contents: Rotate [CH/ENT].
- To pause the 'Call repeat' mode: Push [Pause] . To resume it: Push [Resume Countdown] .

## 8 DSC OPERATION

### ■ Sending a Distress call (Continued)

#### ◇ Resending a Distress call

While waiting for an acknowledgement, you can resend the call. (Repeat call)

1. When “Waiting for ACK” is displayed, push [Resend] .

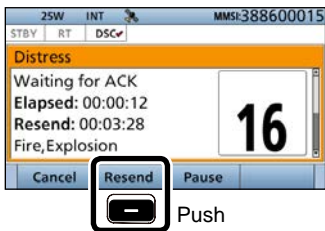



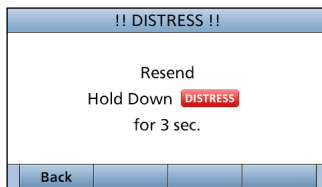

- ① See page 29 or page 30 for details of the Task mode's software key functions.

2. Lift up the key cover, then hold down [DISTRESS] until “Retransmitting” is displayed to resend the call.
  - While holding down [DISTRESS], count down beeps sound, and both the key and display backlighting blink.

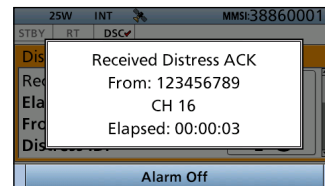

3. When the acknowledgement is received:
  - Alarm sounds.
  - The following screen is displayed.



4. Push any [Alarm Off] .
5. Push any [Close Call RCVD Window] .
6. Hold down [PTT] to announce your situation.
7. Push [Standby]  to return to the Main screen.

### ◇ Sending a Distress Cancel call

While waiting for an acknowledgement, you can send a Distress Cancel call.

1. When “Waiting for ACK” is displayed, push [Cancel] .

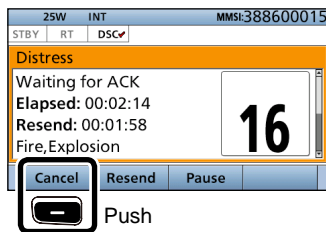

- ① See page 33 for details of the Task mode's Software key functions.

2. Push [Continue]  to send a Distress Cancel call.

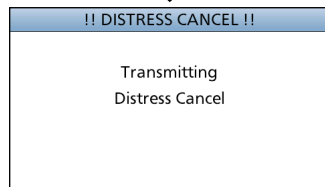
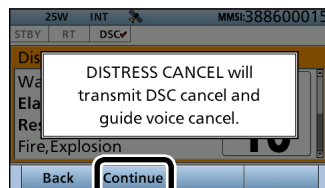

3. After sending, the following screen is displayed.

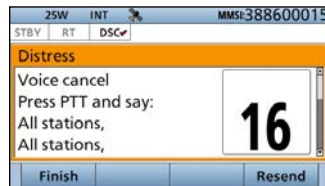

4. Hold down [PTT] to announce your cancel statement.

① Rotate [CH/ENT] to view the cancel statement of the Distress Cancel call.

5. Select the action.  
[Finish]: Finishes the Distress Cancel procedures.  
[Resend]: Sends a Distress Cancel call again.
6. Push [Standby]  to return to the Main screen.

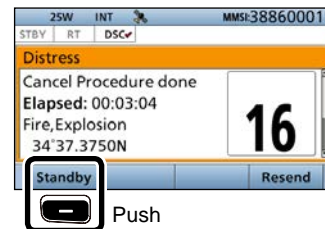

## 8 DSC OPERATION



### ■ Sending a Distress call (Continued)

#### ◇ Sending a Distress Relay acknowledgement

You can send the Distress Relay acknowledgment only when a Distress Relay call is received.

1. When a Distress Relay call is received:
  - Alarm sounds.
  - The following screen is displayed.



2. Push any [Alarm Off] .
3. Push [Accept] .
4. Push  to scroll the software key functions.

5. Push [ACK] .

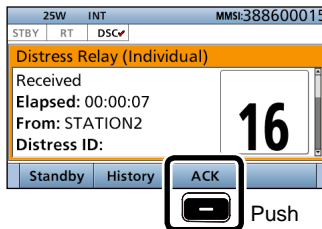

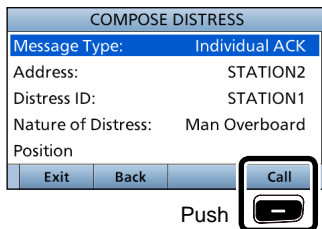

- The call contents screen is displayed.
- ① Rotate [CH/ENT] to view the call contents.

6. Push [Call]  to send the Distress Relay acknowledgement.



7. Hold down [PTT] to communicate.
8. Push [Standby]  to return to the Main screen.

**TIP:** When you push [Pause]  in step 3, the countdown will be paused. Push [Resume]  to resume the countdown.

## ■ Sending a Non-Distress call

To ensure correct operation of the DSC function, confirm you correctly set the Channel 70 squelch level. (p. 63)

**NOTE:**

- Emergency channel (Channel 70) is automatically selected for calling.
- If Channel 70 is busy, the transceiver stands by until the channel becomes clear.

1. Push [Compose Other]  to display the COMPOSE NON-DISTRESS screen.

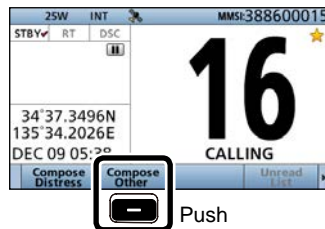

- ① To display the screen from the Menu screen:  
([MENU] > **Compose Non-Distress**)

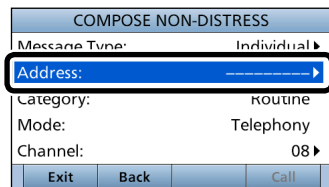

2. Push [ENT].

3. Select the individual address, or "Manual Input," then push [ENT]. (Example: STATION1)

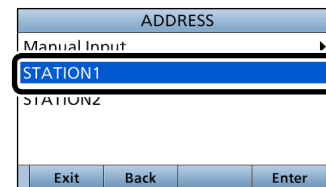

When you select "Manual Input" in step 3, push the keypad to manually enter the Individual ID that you want to call. (p. 25)



### ◇ Sending an Individual call

The Individual call function enables you to transmit a DSC call to only a specific coast station or to a ship. After transmission, wait for an acknowledgement from the receiving station.

You can communicate by voice after receiving the acknowledgement 'ACK (Able).'

# 8 DSC OPERATION

## ■ Sending a Non-Distress call (Continued)

When you select a coast station in step 3, the voice channel is automatically specified by the coast station. Therefore, skip steps 4 and 5, and go to step 6.

4. Select "Channel," then push [ENT].
5. Select the voice channel, then push [ENT].

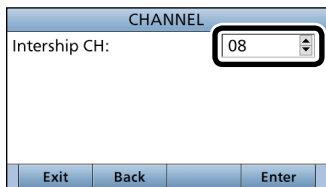

Rotate  
  
 +  
 Push  

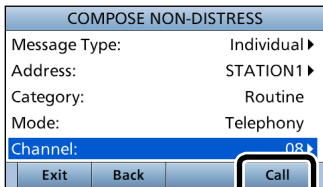

6. Push [Call]  to send the Individual call.



Push



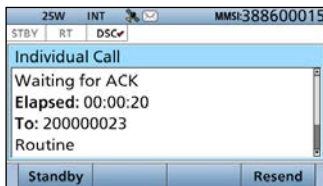

7. After sending, the following screen is displayed.

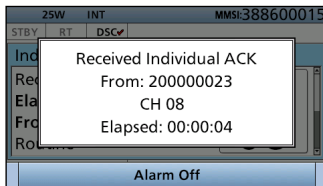

① See page 29 or page 30 for details of the Task mode's Software key functions.

8. When the acknowledgement is received:
  - Alarm sounds.
  - The following screen is displayed. (Example: ACK (Able))



9. Push any [Alarm Off] .

10. Push any [Close Call RCVD Window] .

When you receive "ACK (Unable)" in step 8, skip step 11, and go to step 12.

11. Hold down [PTT] to communicate.
12. Push [Standby]  to return to the Main screen.

### NOTE:

#### After receiving the acknowledgement:

- The voice channel specified in step 5 is selected.
- A different voice channel is selected if the station you called cannot use the channel.





### ◇ Sending an Individual acknowledgement

When receiving an Individual call, you can send an acknowledgement ('Able,' 'Unable,' or 'New CH') by using the on-screen prompts.

1. When an Individual call is received:
  - Alarm sounds.
  - The following screen is displayed.



2. Push any [Alarm Off] .
3. Push [Accept] .

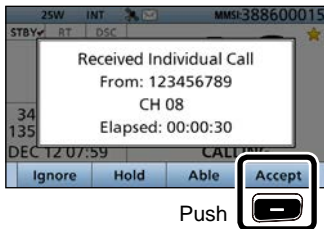

- Enters the DSC Task mode.

4. Select your action.

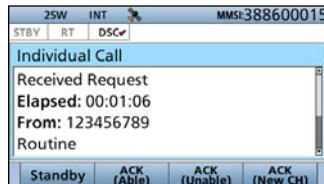

[ACK (Able)]:  
Sends an acknowledgment without any changes.

[ACK (Unable)]:  
Sends an acknowledgment, but you cannot make a communication.

[ACK (New CH)]:  
Sends an acknowledgment. You can specify the Voice Communication channel.

5. Push [Call]  to send the Individual acknowledgement.

When you push [ACK (Unable)] in step 5, skip step 7, and go to step 8.

6. Hold down [PTT] to communicate.
7. Push [Standby]  to return to the Main screen.

## 8 DSC OPERATION

### ■ Sending a Non-Distress call (Continued)

#### ◇ Sending an All Ships call

All ships, that have DSC transceiver, use Channel 70 as their 'listening channel.' When you want to announce a message to these ships, if they are within range, use the 'All Ships Call' function.

1. Push [Compose Other]  to display the COMPOSE NON-DISTRESS screen.  
① To display the screen from the Menu screen:  
([MENU] > **Compose Non-Distress**)
2. Select "Message Type," then push [ENT].

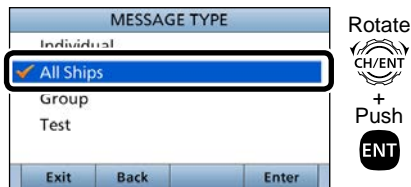

3. Select "All Ships," then push [ENT].
4. Select "Category," then push [ENT].

5. Select the option, then push [ENT].  
(Example: Safety)



6. Select "Channel," then push [ENT].
7. Select the voice channel, then push [ENT].

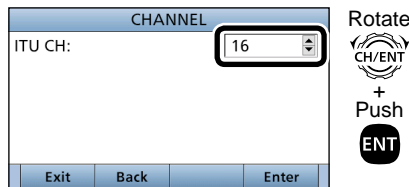

8. Push [Call]  to send the All ships call.

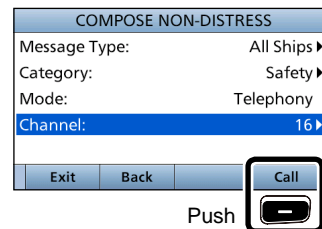

9. After sending, the following screen is displayed.

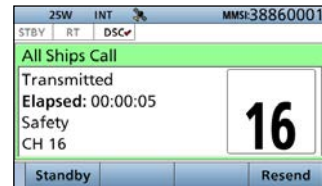

- ① See page 29 or page 30 for details of the Task mode's software key functions.
10. Hold down [PTT] to announce your message.
11. Push [Standby]  to return to the Main screen.

### ◇ Sending a Group call

The Group call function allows you to transmit a DSC call to only a specific group.

1. Push [Compose Other]  to display the COMPOSE NON-DISTRESS screen.
  - ① To display the screen from the Menu screen:  
([MENU] > **Compose Non-Distress**)
2. Select "Message Type," then push [ENT].
3. Select "Group," then push [ENT].

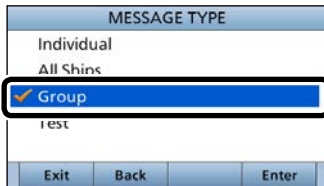

Rotate  
CH/ENT  
+ Push  
ENT

4. Select "Address," then push [ENT].
5. Select the Group address or "Manual Input," then push [ENT].  
(Example: GROUP1)

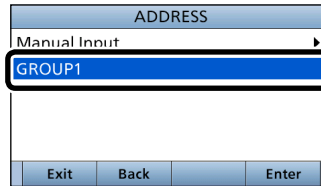

Rotate  
CH/ENT  
+ Push  
ENT

When you select "Manual Input" in step 5, push the keypad to manually enter the Group ID. (p. 26)



6. Select "Channel," then push [ENT].
7. Select the voice channel, then push [ENT].

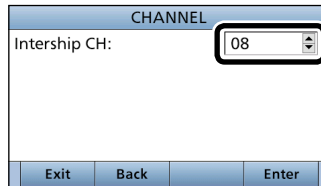

Rotate  
CH/ENT  
+ Push  
ENT

8. Push [Call]  to send the Group call.

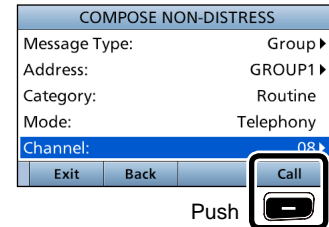

Push

9. After sending, the following screen is displayed.



- ① See page 29 or page 30 for details of the Task mode's software key functions.
10. Hold down [PTT] to announce the message.
11. Push [Standby]  to return to the Main screen.

## 8 DSC OPERATION

### ■ Sending a Non-Distress call (Continued)

#### ◇ Sending a Position Request call/Polling Request call (For only the USA version)

- Send a Position Request call when you want to know a specific ship's current position, and so on.
- Send a Polling Request call when you want to know if a specific vessel is in the communication area, or not.

4. Select "Address," then push [ENT].
5. Select an Individual address, or "Manual Input."  
(Example: STATION1)

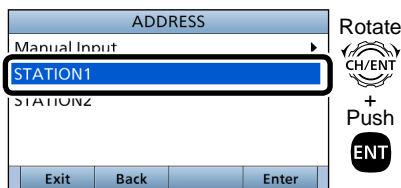

**Example:** Sending a Position Request call

1. Push [Compose Other] to display the COMPOSE NON-DISTRESS screen.
  - ① To display the screen from the Menu screen:  
([MENU] > **Compose Non-Distress**)
2. Select "Message Type," then push [ENT].
3. Select the call to send, then push [ENT].



6. Push [Call] to send the call.

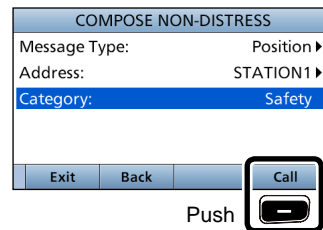

7. After sending, the following screen is displayed.

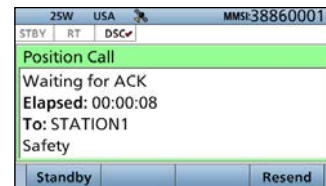

When you select "Manual Input" in step 5, push the keypad to manually enter the Individual ID that you want to call.



- ① See page 29 or page 30 for details of the Task mode's software key functions.

8. When the Reply call is received:
  - Alarm sounds.
  - The following screen is displayed.



9. Push any [Alarm Off] .
10. Push any [Close Call RCVD Window] .
  - The call contents screen is displayed.

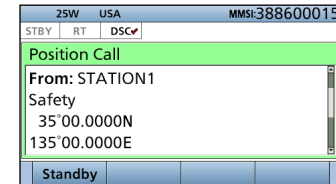



11. Push [Standby]  to return to the Main screen.

### ◇ Sending a Position Request acknowledgement

When a Position Request call is received, you can send an acknowledgement.

1. When a Position Request call is received:
  - Alarm sounds.
  - The following screen is displayed.



2. Push any [Alarm Off] .
3. Push [Accept] .
  - Enters the DSC Task mode.

4. Select your action.

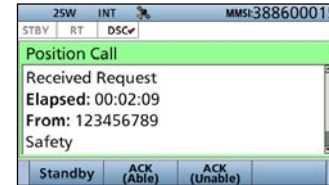

[ACK (Able)]:

Sends an acknowledgment with position and time data.



[ACK (Unable)]:

Sends an acknowledgment with no position and time data.

① The call contents screen is displayed.

① Rotate [CH/ENT] to view the call contents.

- Change your position data, if the displayed data is invalid. (p. 27)

5. Push [Call]  to send the acknowledgement.
  - When [ACK (Able)] is selected in step 5, your position and time data are transmitted.
6. Push [Standby]  to return to the Main screen.



**TIP:** When “Position ACK” is set to Auto, the transceiver automatically sends the acknowledgement. (p. 60)

## 8 DSC OPERATION

### ■ Sending a Non-Distress call (Continued)

#### ◇ Sending a Polling Reply call (For only the USA version)

Send a Polling Reply call when a Polling Request call is received.

1. When a Polling Request call is received:
  - Alarm sounds.
2. Push any [Alarm Off] .
3. Push [Accept] .



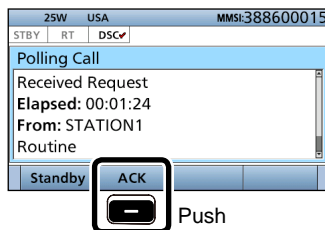

- Enters the DSC Task mode.

4. Push [ACK] .



- The call contents screen is displayed.  
① Rotate [CH/ENT] to view the call contents.

5. Push [Call]  to send the Reply call.
6. Push [Standby]  to return to the Main screen.

**TIP:** When “Polling ACK” is set to “Auto,” the transceiver automatically sends the call.

#### ◇ Sending a Test call

Testing on the exclusive DSC distress and safety calling channels should be avoided as much as possible by using other methods.

Normally the Test call would require no further communications between the two stations involved.

1. Push [Compose Other]  to display the COMPOSE NON-DISTRESS screen.  
① To display the screen from the Menu screen:  
([MENU] > **Compose Non-Distress**)
2. Select “Message Type,” then push [ENT].
3. Select “Test.”

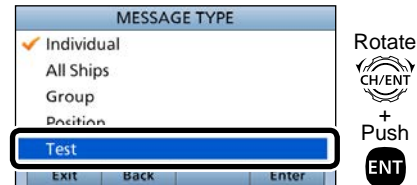

4. Select “Address,” then push [ENT].

5. Select the Individual address, or "Manual Input."  
(Example: STATION1)

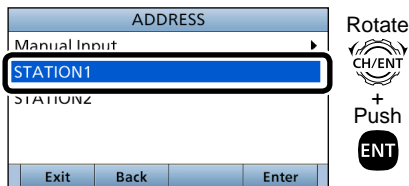

When you select "Manual Input" in step 5, push the keypad to manually enter the Individual ID. (p. 25)



6. Push [Call] to send the Test call.

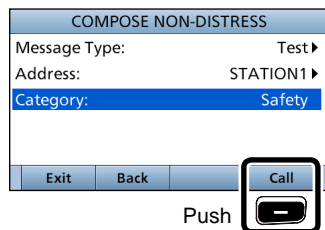

7. After sending, the following screen is displayed.

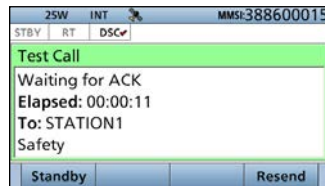

① See page 29 or page 30 for details of the Task mode's Software key functions.

8. When the acknowledgement is received:
  - Alarm sounds.
  - The following screen is displayed.

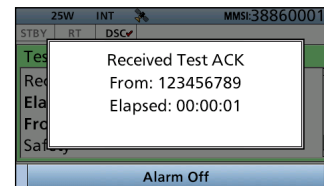



9. Push any [Alarm Off] .
10. Push any [Close Call RCVD Window] .
  - Enters the DSC Task mode.
11. Rotate [CH/ENT] to view the received message log.
12. Push [Standby] to return to the Main screen.

## 8 DSC OPERATION

### ■ Sending a Non-Distress call (Continued)

#### ◇ Sending a Test call acknowledgement

When a Test call is received, you can send an acknowledgement.

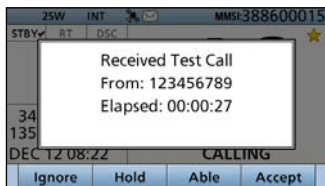

1. When a Test call is received:
  - Alarm sounds.
2. Push any [Alarm Off] .
3. Push [Accept] .



- Enters the DSC Task mode.

4. Push [ACK] .



- The call contents screen is displayed.
- ① Rotate [CH/ENT] to view the call contents.
  5. Push [Call]  to send the acknowledgement.
  6. Push [Standby]  to return to the Main screen.

**TIP:** When “Test ACK” is set to “Auto,” the transceiver automatically sends the acknowledgement. (p. 60)



## ■ Receiving DSC calls

### NOTE: After receiving a DSC call

“✉” continuously blinks when the transceiver has DSC call, or an unread DSC message in the Received Call Log. (p. 58)

### ◇ Receiving a Distress Call

#### IMPORTANT!

Distress call reception should stop after one sequence because the coast station should send back an ‘acknowledgement’ to the ship. If the distress call continues, even after the coast station sends back an ‘acknowledgement,’ the ship in distress may not receive the acknowledgement.

1. When a Distress call is received:
  - Alarm sounds.
  - The following screen is displayed and the backlight blinks.
  - “✉” blinks.

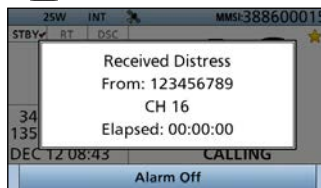

2. Push any [Alarm Off] .
3. Select your action.





[Ignore]\*: Ignores the Call and returns to the Main screen.

\* Displayed only when “Single” is selected in the PROCEDURE menu. (p. 64)

[Hold]: Holds the RX call task, and returns to the Main screen.

[Pause]: Pauses the countdown.
 

- To restart the countdown, push [Resume] .

[Accept]: Enters the DSC Task mode. To send the acknowledgement, push [Accept] .



#### DSC Task mode (pp. 29, 30)

- Automatically selects Channel 16, and then you should monitor it, because a coast station may require assistance.
- Rotate [CH/ENT] to view the call contents.



## 8 DSC OPERATION

### ■ Receiving DSC calls (Continued)

#### ◇ Receiving a Distress acknowledgement

- When a Distress acknowledgement sent to another ship is received:
  - Alarm sounds.
  - The following screen is displayed and the backlight blinks.
  - “✉” blinks.



- Push any [Alarm Off] .
- Push any [Close Call RCVD Window] .

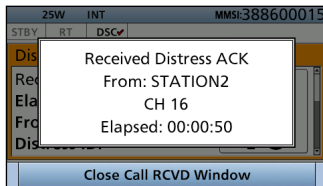

- Enters the DSC Task mode.

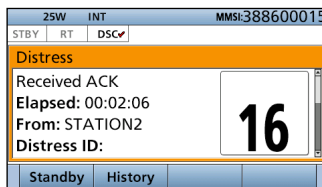



#### DSC Task mode (pp. 29, 30)

- Automatically selects Channel 16, and then monitor it, because a coast station may require assistance.
  - Rotate [CH/ENT] to view the call contents.
- Push [Standby]  to return to the Main screen.

#### ◇ Receiving a Distress Cancel call

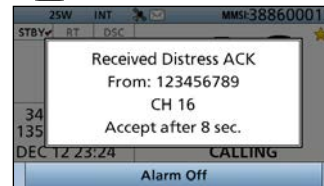
- When a Distress Cancel call is received:
  - Alarm sounds.
  - The following screen is displayed and the backlight blinks.
  - “✉” blinks.



- Push any [Alarm Off] .
- Select your action.

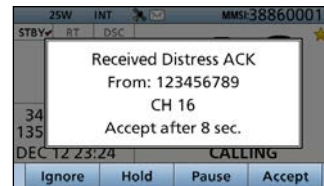

[Ignore]\*: Ignores the Call and returns to the Main screen.

\* Displayed only when “Single” is selected in the PROCEDURE menu. (p. 64)

[Hold]: Holds the RX call task, and returns to the Main screen.

[Pause]: Pauses the countdown.  
• To restart the countdown, push [Resume] .

[Accept]: Enters the DSC Task mode.



**DSC Task mode (pp. 29, 30)**

- Automatically selects Channel 16, and then you should monitor it, because a coast station may require assistance.
  - Rotate [CH/ENT] to view the call contents.
4. Push [Standby]  to return to the Main screen.

**◇ Receiving a Distress Relay call**

1. When a Distress Relay call is received:
  - Alarm sounds.
  - The following screen is displayed and the backlight blinks.
  - “” blinks.



2. Push any [Alarm Off] .
3. Select the action.



[Ignore]\*: Ignores the Call and returns to the Main screen.

\* Displayed only when “Single” is selected in the PROCEDURE menu. (p. 64)

[Hold]: Holds the RX call task, and returns to the Main screen.

[Pause]: Pauses the countdown.  
• To restart the countdown, push [Resume] .

[Accept]: Enters the DSC Task mode. To send the acknowledgement, push [Accept] .

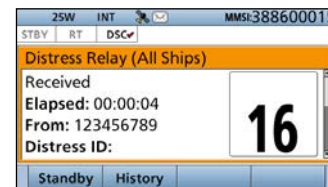

**DSC Task mode (pp. 29, 30)**

- Automatically selects Channel 16, and then monitor it, because a coast station may require assistance.
  - Rotate [CH/ENT] to view the call contents.
4. Push [Standby]  to return to the Main screen.

**TIP:** See page 36 for details of sending acknowledgement.



## 8 DSC OPERATION

### ■ Receiving DSC calls (Continued)

#### ◇ Receiving a Distress Relay acknowledgement

1. When a Distress Relay acknowledgement is received:
  - Alarm sounds.
  - “✉” blinks.
  - The following screen is displayed and the backlight blinks.



2. Push any [Alarm Off] .
3. Push any [Close Call RCVD Window] .

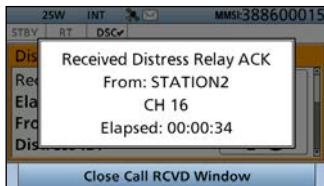

- Enters the DSC Task mode.

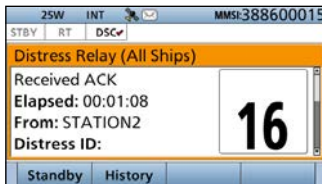

#### DSC Task mode (pp. 29, 30)

- Automatically selects Channel 16, and then you should monitor it, because a coast station may require assistance.
  - [PTT] is activated for voice communication via Channel 16.
  - Rotate [CH/ENT] to view the call contents.
4. Push [Standby]  to return to the Main screen.

### ◇ Receiving an Individual call

**NOTE:** When the “Individual ACK” item is set to “Auto,” the transceiver automatically sends an acknowledgement. Both the TX and RX calls are stored in the Transmitted and Received Call Logs. (pp. 58, 59)

1. When an Individual call is received:
  - Alarm sounds.
  - The following screen is displayed and the backlight blinks.
  - “✉” blinks.



2. Push any [Alarm Off] .
3. Select your action.



[Ignore]\*: Ignores the Call and returns to the Main screen.

\* Displayed only when “Single” is selected in the PROCEDURE menu. (p. 64)

[Hold]: Holds the RX call task, and returns to the Main screen.

[Able]: Sends an acknowledgment without any changes.

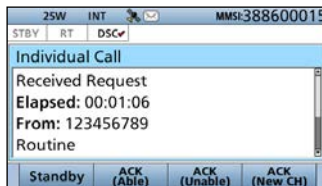

[Accept]: Enters the DSC Task mode.



#### DSC Task mode (pp. 29, 30)

- Rotate [CH/ENT] to view the call contents.

When you select [Accept]  in step 3, you can send an acknowledgement in the DSC Task mode. To send the acknowledgement, go to step 4. If you return to the Main screen without sending the acknowledgement, go to step 7.

4. Push the key to select an acknowledgement option.
5. Push [Call]  to send the Individual acknowledgement.
6. Depending on the option selected in step 5, hold down [PTT] to communicate.
7. Push [Standby]  to return to the Main screen.

**TIP:** When you send the acknowledgement, select one of three options, depending on your situation. See page 39 for details of the Individual acknowledgement procedures.

## 8 DSC OPERATION

### ■ Receiving DSC calls (Continued)

#### ◇ Receiving an Individual acknowledgement

##### When receiving “ACK (Able)”:

You can make voice communication on the channel that you specified when you sent the call.

1. When an Individual acknowledgement “ACK (Able)” is received:
  - Alarm sounds.
  - The following screen is displayed and the backlight blinks.
  - “✉” blinks.

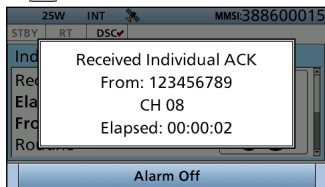

2. Push any [Alarm Off] .

3. Push any [Close Call RCVD Window] .

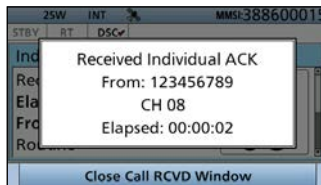

- Enters the DSC Task mode.



##### DSC Task mode (pp. 29, 30)

- Automatically selects the channel that you specified when you sent the call for voice communication.
- Rotate [CH/ENT] to view the call contents.

4. Hold down [PTT] to communicate.
5. Push [Standby]  to return to the Main screen.

**When receiving “ACK (Unable)”:**

You cannot make the voice communication.

- When an Individual acknowledgement “ACK (Unable)” is received:
  - Alarm sounds.
  - The following screen is displayed and the backlight blinks.
  - “✉” blinks.

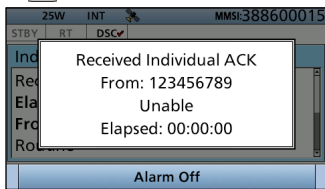

- Push any [Alarm Off] .

- Push any [Close Call RCVD Window] .

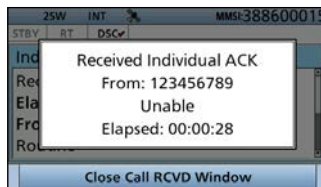

- Enters the DSC Task mode.

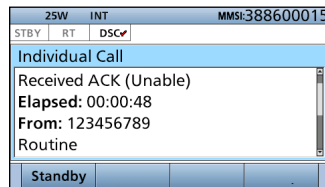

**DSC Task mode (pp. 29, 30)**

- Rotate [CH/ENT] to view the call contents.
- Push [Standby]  to return to the Main screen.

**When receiving “ACK (New CH)”:**

You can make voice communication on the channel that is proposed by the called station.

- When an Individual acknowledgement “ACK (New CH)” is received:
  - Alarm sounds.
  - The following screen is displayed and the backlight blinks.
  - “✉” blinks.

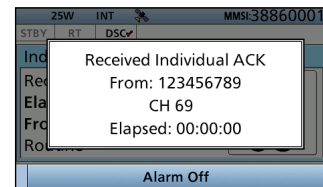

- Push any [Alarm Off] .

## 8 DSC OPERATION

### ■ Receiving DSC calls (Continued)

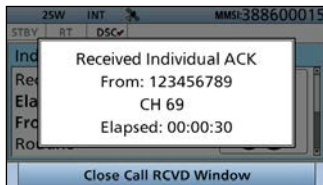

3. Push any [Close Call RCVD Window] .



- Enter the DSC Task mode



#### DSC Task mode (pp. 29, 30)

- Automatically selects the channel that is proposed by the called station for voice communication.
  - Rotate [CH/ENT] to view the call contents.
4. Hold down [PTT]  to communicate.
  5. Push [Standby]  to return to the Main screen.

### ◇ Receiving an All Ships call

1. When an All Ships call is received:

- Alarm sounds.
- The following screen is displayed and the backlight blinks.
- “” blinks.

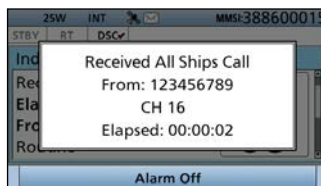



2. Push any [Alarm Off] .
3. Select your action.



[Ignore]\*: Ignores the Call and returns to the Main screen.

\* Displayed only when “Single” is selected in the PROCEDURE menu. (p. 64)

[Hold]: Holds the RX call task, and returns to the Main screen.

- [Pause]: Push [Pause]  to pause the countdown.
- To restart the countdown, push [Resume] .
- [Accept]: Push [Accept]  to enter the DSC Task mode.

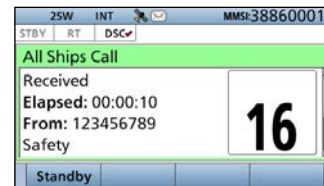

#### DSC Task mode (pp. 29, 30)

- Monitor the channel specified by the calling station for an announcement from the calling station. (Example: Channel 16)
  - Rotate [CH/ENT] to view the call contents.
4. Push [Standby]  to return to the Main screen.



◇ Receiving a Group call

1. When a Group call is received:
  - Alarm sounds.
  - The following screen is displayed and the backlight blinks.
  - “✉” blinks.



2. Push any [Alarm Off] .
3. Select your action.



[Ignore]\*: Ignores the Call and returns to the Main screen.

\* Displayed only when “Single” is selected in the PROCEDURE menu. (p. 64)

[Hold]: Holds the RX call task, and returns to the Main screen.

[Pause]: Pauses the countdown.
 

- To restart the countdown, push [Resume] .

[Accept]: Enters the DSC Task mode.



**DSC Task mode (pp. 29, 30)**

- Monitor the channel specified by the calling station for an announcement from the calling station. (Example: Channel 08)
  - Rotate [CH/ENT] to view the call contents.
4. Push [Standby]  to return to the Main screen.

## 8 DSC OPERATION

### ■ Receiving DSC calls (Continued)

#### ◇ Receiving a Position Request call

**NOTE:** When “Position ACK” is set to “Auto,” the transceiver automatically replies to the call. Both the TX and RX calls are stored in the Transmitted and Received Call Logs. (Default: Manual)

1. When a Position Request call is received:
  - Alarm sounds.
  - The following screen is displayed and the backlight blinks.



2. Push any [Alarm Off] .
3. Select your action.



[Ignore]\*:

Ignores the Call and returns to the Main screen.

\* Displayed only when “Single” is selected in the PROCEDURE menu. (p. 64)

[Hold]:

Holds the RX call task, and returns to the Main screen.

[ACK (Unable)]:

Sends an acknowledgment with no position and time data.

[ACK (Able)]:

Sends an acknowledgment with position and time data.

[Accept]:

Enters the DSC Task mode.

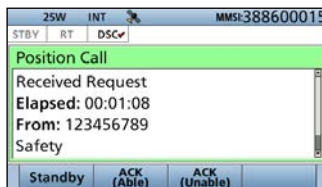

#### DSC Task mode (pp. 29, 30)

- Rotate [CH/ENT] to view the call contents.
4. Push [Standby]  to return to the Main screen.



**TIP:** See page 43 for details of sending an acknowledgement.

#### ◇ Receiving a Test call /Polling Request call\*

\*For only the USA version.

**NOTE:** When “Test ACK” or “Polling ACK” is set to “Auto,” the transceiver automatically replies to the call. Both the TX and RX calls are stored in the Transmitted and Received Call Logs.

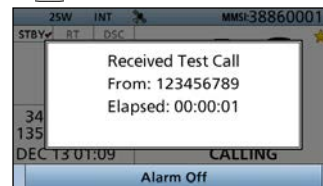
**Example:** Receiving a Test call

1. When a call is received:
  - Alarm sounds.
  - The following screen is displayed and the backlight blinks.
  - “

2. Push any [Alarm Off] .
3. Select your action.



[Ignore]\*: Ignores the Call and returns to the Main screen.

\* Displayed only when "Single" is selected in the PROCEDURE menu. (p. 64)

[Hold]: Holds the RX call task, and returns to the Main screen.

[ACK]: Sends an acknowledgment.

[Accept]: Enters the DSC Task mode.

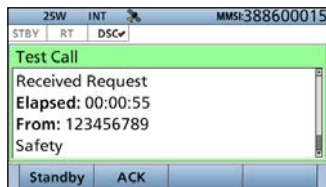

**DSC Task mode (pp. 29, 30)**

- Rotate [CH/ENT] to view the call contents.

4. Push [Standby]  to return to the Main screen.

**TIP:** See page 46 for details of sending a Test acknowledgement.

◇ **Receiving a Test acknowledgement/Position Reply call\* /Polling Reply call\*** \*For only the USA version.

**Example:** Receiving a Test acknowledgement

1. When a call is received:
  - Alarm sounds.
  - The following screen is displayed and the backlight blinks.
  - "✉" blinks.

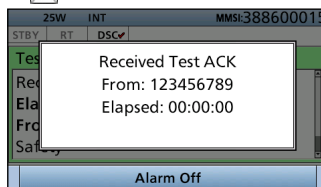

2. Push any [Alarm Off] .

3. Push any [Close Call RCVD Window] .

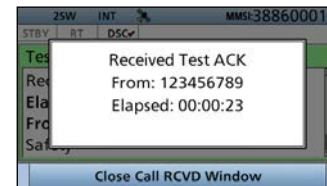

- Enters the DSC Task mode.

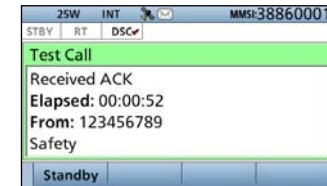

**DSC Task mode (pp. 29, 30)**

- Rotate [CH/ENT] to view the call contents.

4. Push [Standby]  to return to the Main screen.

## ■ Received Call log

The transceiver automatically stores up to 50 distress messages and 50 other messages, and they can be used as a supplement to your logbook.

- When there is an unread DSC message, “✉” blinks on the information area of the LCD.
- “✉” is displayed when there are unread DSC messages.
- “✉” is displayed when there are no unread DSC messages.
- No icon is displayed when there are no DSC messages.
- Distress messages are stored in “Distress.”

### Software key functions in the RECEIVED CALL LOG screen:

- [Exit]: Push to return to the Main screen.  
 [Back]: Push to return to the previous screen.  
 [Delete]: Push to delete the selected message.  
 [Enter]: Push to go to the next screen.

### ◇ Distress message

1. Push [DSC Log]  to display the RECEIVED CALL LOG screen.
  - To display the screen from the Menu screen:  
 ([MENU] > DSC Log > **Received Call Log**)
2. Select “Distress,” then push [ENT].
3. Select the message, then push [ENT].



4. Rotate [CH/ENT] to view the contents.
  - To view another message, push [CLR] to return to the previous screen. Then select the message.
5. Push [Exit]  to return to the Main screen.

### ◇ Other messages

1. Push [DSC Log]  to display the RCVD CALL LOG screen.
  - To display the screen from the Menu screen:  
 ([MENU] > DSC Log > **Received Call Log**)
2. Select “Others,” then push [ENT].
3. Select the message, then push [ENT].

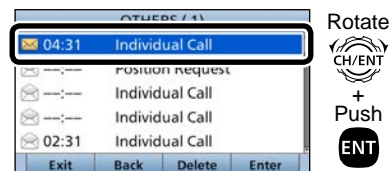

4. Rotate [CH/ENT] to view the contents.
  - To view another message, push [CLR] to return to the previous screen. Then select the message.
5. Push [Exit]  to return to the Main screen.

## ■ Transmitted Call log

The transceiver automatically stores up to 50 transmitted calls, and the logs can be used as a supplement to your logbook.

### Software key functions in the TRANSMITTED CALL LOG screen:

[Exit]: Push to return to the Main screen.

[Back]: Push to return to the previous screen.

[Delete]: Push to delete the selected message.

[Enter]: Push to go to the next screen.

1. Push [MENU].
2. Select "Transmitted Call Log."  
(DSC Log > **Transmitted Call Log**)

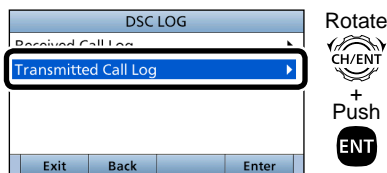

3. Select the message, then push [ENT].

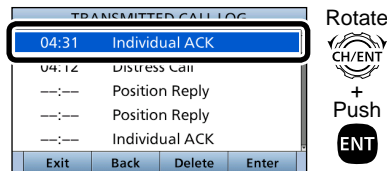

4. Rotate [CH/ENT] to view the contents.
  - To view another message, push [CLR] to return to the previous screen. Then select the message.
5. Push [Exit]  to return to the Main screen.

## ■ DSC Settings

- ◇ Position Input (See page 27)
- ◇ Individual ID (See page 25)
- ◇ Group ID (See page 26)

### ◇ Automatic

#### Acknowledgement

You can set the Automatic Acknowledgment function to acknowledge DSC calls.

When you receive an Individual call, Position Request call, Polling Request call or Test call, the transceiver automatically sends each acknowledgement, if “Auto” is set.

When you set the “Individual ACK” item to “Auto (Unable),” and receive the Individual call, the transceiver automatically sends the acknowledgment, including “ACK (Unable)” (No Reason Given).

1. Push [MENU].
2. Select “Auto ACK.”  
(DSC Settings > **Auto ACK**)
3. Select the item.  
(DSC Settings > Auto ACK > **Individual ACK**)  
(DSC Settings > Auto ACK > **Position ACK**)  
(DSC Settings > Auto ACK > **Polling ACK**)  
(DSC Settings > Auto ACK > **Test ACK**)
4. Select the option, then push [ENT].

#### Individual ACK

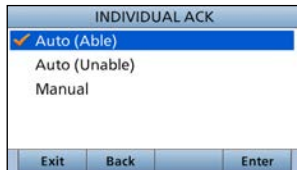

(Default: Auto (Able))

#### Position ACK

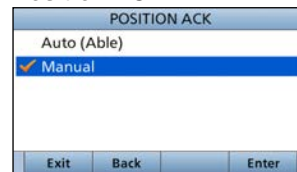

(Default: Manual)

#### Polling ACK

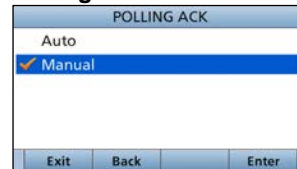

(Default: Manual)

#### Test ACK

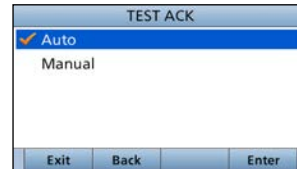

(Default: Auto)

5. Push [MENU] to return to the Main screen.

### ◇ Channel Auto Switch

By regulation, after receiving a DSC call, the transceiver changes the operating channel to the channel assigned by the received DSC call. However, when this setting is set to “OFF,” the function enables the transceiver to remain on the operating channel, even after receiving a Distress call.

1. Push [MENU].
2. Select “CH Auto Switch:,” then push [ENT].  
(DSC Settings > CH Auto Switch:)

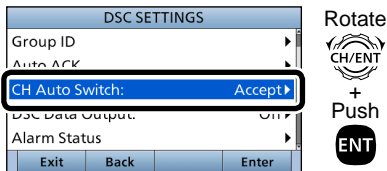

3. Select the option, then push [ENT].

### Accept after 10 sec.

After receiving a DSC call, the transceiver remains on the current operating channel for 10 seconds. After that, the transceiver automatically switches to the channel that assigned by the received DSC call.

### Ignore after 10 sec.\*1

After receiving a DSC call, the transceiver remains on the current operating channel for 10 seconds. After that, the transceiver automatically returns to the Main screen.

### Hold after 10 sec.\*2

After receiving a DSC call, the transceiver remains on the current operating channel for 10 seconds. After that, the transceiver automatically holds the received DSC call and returns to the Main screen.

### Manual

The user need to select whether or not to accept the received DSC call.

\*1 Displayed only when “Single” is selected in the PROCEDURE menu.  
(p. 64)

\*2 Displayed only when “Multiple” is selected in the PROCEDURE menu.  
(p. 64)

4. Push [Exit]  to return to the Main screen.

## 8 DSC OPERATION

### ■ DSC Settings (Continued)

#### ◇ DSC data output

When receiving a DSC call, this function makes the transceiver send the DSC data from its NMEA Output port to an external device.

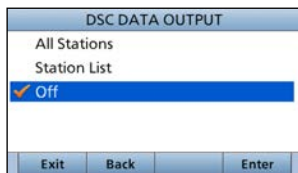

**All Stations:** Outputs the call from any vessel from the NMEA Output port.

**Station List:** Outputs the call from any vessels listed on the Individual ID screen.

**OFF:** Does not output any call to an external device (Default).

#### ◇ Setting the Alarm Status

##### • Safety

##### • Routine

Select whether or not to sound an alarm when receiving a Safety or Routine DSC call.

1. Push [MENU].
2. Select the item, then push [ENT].  
(DSC Settings > Alarm Status > **Safety**)  
(DSC Settings > Alarm Status > **Routine**)

(Example: Safety)

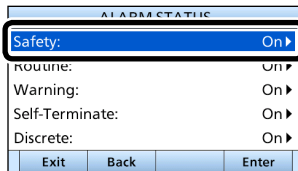

3. Select the option, then push [ENT].
  - On: Alarm sounds. (Default)
  - Off: Alarm does not sound.
4. Push [MENU] to return to the Main screen.

##### • Warning

Select whether or not to sound an alarm:

- When no MMSI code is entered.
- When the position data has not been updated for 10 minutes.
- When the position data has not been manually updated for 4 hours.
- After the invalid GPS position data or manually entered position data has not been updated for 23.5 hours.

1. Push [MENU].
2. Select “Warning,” then push [ENT].  
(DSC Settings > Alarm Status > **Warning**)

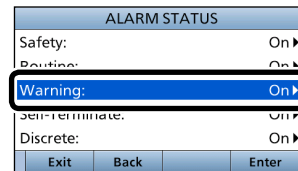

3. Select the option, then push [ENT].
  - On: Alarm sounds. (Default)
  - Off: Alarm does not sound.
4. Push [MENU] to return to the Main screen.



• **Self-Terminate**

Select whether or not to sound an alarm when receiving the same Distress call.

1. Push [MENU].
2. Select “Self-Terminate,” then push [ENT].  
(DSC Settings > Alarm Status > **Self-Terminate**)

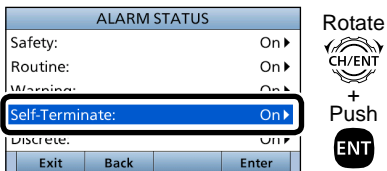

3. Select the option, then push [ENT].
  - On: Alarm sounds. (Default)
  - Off: Alarm does not sound.
4. Push [MENU] to return to the Main screen.

• **Discrete**

Select whether or not to sound an alarm when receiving a DSC call while in the Radio Telephone (RT) mode or DSC Task mode.

1. Push [MENU].
2. Select “Discrete,” then push [ENT].  
(DSC Settings > Alarm Status > **Discrete**)

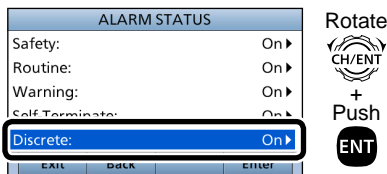

3. Select the option, then push [ENT].
  - On: Alarm sounds. (Default)
  - Off: Alarm does not sound.
4. Push [MENU] to return to the Main screen.

◇ **Setting the Channel 70 Squelch level**

Set the squelch level on Channel 70. The transceiver has 11 squelch levels between 1 (loose squelch), 10 (tight squelch) and ‘Open’ (squelch is completely open).

1. Push [MENU].
2. Select “CH 70 SQL Level,” then push [ENT].
3. (DSC Settings > **CH 70 SQL Level**):

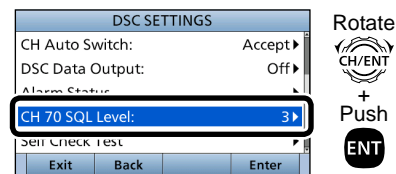

4. Adjust the squelch level until the noise just disappears.

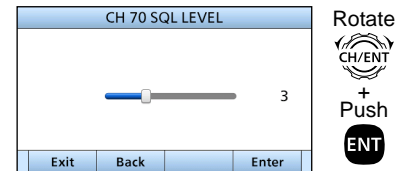

5. Push [MENU] to return to the Main screen.

## 8 DSC OPERATION

### ◇ Self Check Test

The Self Check test function sends transmit DSC signals to the receive AF circuit to compare and check the TX and RX signals at the AF level.

1. Push [MENU].
2. Select "Self Check test," then push [ENT].  
(DSC Settings > **Self Check Test**)

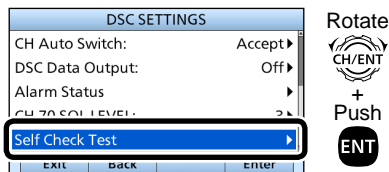

3. Push [ENT] to start the DSC loop test.

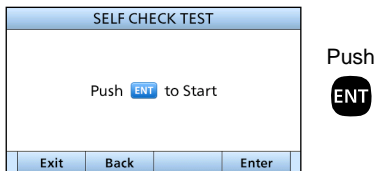

- If the transmit DSC and receive DSC signals match, "OK" is displayed.
4. Push [MENU] to return to the Main screen.

### ◇ Selecting the DSC procedure

(For only the USA version.)

Select weather or not to enable the transceiver handling more than 2 tasks at same time.

See page 29 and page 30 for the Single task and Multiple task details.

1. Push [MENU].
2. Select "Procedure:," then push [ENT].  
(DSC Settings > **Procedure:**)

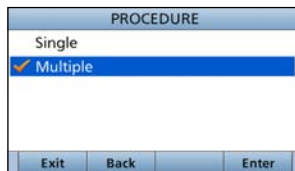

3. Select the option, then push [ENT].
  - Single: The transceiver handles a single task (Default).
  - Multiple: The transceiver can handle up to 7 tasks at same time .
4. Push [MENU] to return to the Main screen.

## ■ Making an Individual call to a particular AIS target

You can transmit an Individual DSC call to a selected AIS target, without entering the target's MMSI code. In this case, the call type is automatically set to Routine.

**NOTE:** To ensure correct operation of the DSC function, make sure you correctly set the CH70 SQL Level. (p. 63)

### The transceiver with a built-in AIS receiver:

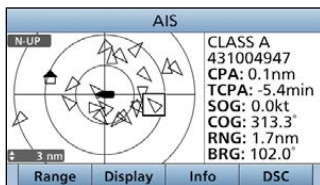

You can select an AIS target on the Target List screen or Danger list screen.

1. Display the AIS plotter screen (p. 74), or the Target List screen (p. 75).



TARGET LIST (93)		
MMSI/Name	RNG	BRG
431004947	3.3	154
431004948	3.4	147
431004949	3.4	249
431004950	3.9	259

Buttons: Display INFO DSC

2. Select a target, and then push [DSC]  to display the Voice channel selection screen.
3. Select a Voice channel, and then push [DSC]  to transmit an Individual call.
  - If Channel 70 is busy, the transceiver stands by until the channel becomes clear.
  - If the transceiver cannot make the call, the transponder will display "DSC Transmission FAILED."

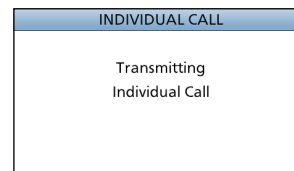

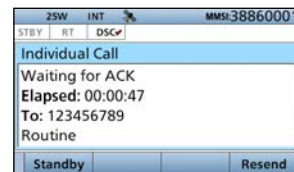

4. The transceiver stands by on Channel 70 until an acknowledgement is received.



---

## 8 DSC OPERATION

### ■ Making an Individual call using an AIS transponder (Continued)

5. When the acknowledgement is received, alarm sounds.
  - If the acknowledgement 'Able to comply' is received, push [ALARM OFF]  to stop the alarm, and then select the Intership channel specified in step 2.
    - A different Intership channel will be selected if the station you called cannot use the channel.
    - To reply, push [PTT] and speak at a normal voice level.
    - You can check the MMSI code or the name, if entered, of the AIS target on the display.
  - If the acknowledgement 'Unable to comply' is received, push [ALARM OFF]  to stop the alarm, then "INDIVIDUAL CALL FAILED" is displayed.
6. After the communication is finished, push [Standby]  to return to the normal operating mode.

### **The transceiver without built-in AIS receiver:**

If you are using the transceiver without a built-in AIS receiver, select an AIS target using an optional MA-500TR class B AIS transponder.

See the instruction manual boxed with the transponder for details.

## ■ Using the Intercom

The optional Intercom function enables you to talk between the deck and the cabin. The optional RC-M600 COMMAND HEAD, HM-195 COMMANDMICIV™\*, or HM-229 COMMANDMICV™ is required for Intercom operation.

- ① Connect the RC-M600 as described on page 96.
- ① Connect the HM-195\* or HM-229 as described on page 100.
- \*Not usable for the IC-M605EURO.
- Transmitting is disabled while using the intercom.
- The received call audio is muted while using the intercom.

1. Push [MENU].
2. Select “Intercom,” then push [ENT].
3. Select the unit, then push [ENT].
  - Enters the Intercom mode.
4. Hold down [Call]  to sound the intercom beeps.
  - The transceiver and the command head or command microphone sound beeps while holding down [Call].
  - “Call” is displayed.

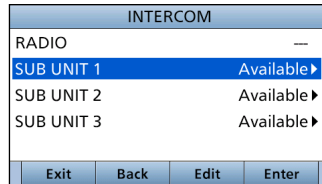

5. After releasing [Call], hold down [PTT] and speak into the microphone at your normal voice level.
  - “Talk” is displayed.
  - ① To adjust the transceiver or command head’s intercom volume level, rotate [VOL/SQL].
  - ① To adjust the command microphone’s intercom volume level, rotate [VOL/SQL] (Dial) on the command microphone.
6. After releasing [PTT], you can hear the response through the speaker.





7. Push [EXIT]  to return to the Main screen.

**NOTE:** While in the Intercom mode, the transmit and receive functions are disabled. When the transceiver is transmitting, the Intercom function is disabled.

## 9 OTHER FUNCTIONS

### ■ Using the RX Hailer



The RX Hailer function enables you to hear the received audio on the deck or bridge through a Hailer speaker. Connect an external hailer speaker as described on page 94.

1. Push [◀] or [▶] until [RX Hailer] is displayed in the Software Key area.
2. Push [RX Hailer]  to enter the RX Hailer mode.
  - The "RX"  icon is displayed.



- ① Push [VOL/SQL] to open the volume adjustment screen.



3. To exit the RX hailer mode, push [RX Hailer] .
  - The "RX"  icon disappears.

### ■ Using the Hailer

You can talk without leaving the bridge by using the 2 way hailer function.

Connect an external hailer speaker as described on page 94.

- You cannot transmit while using the hailer.

1. Push [MENU].
2. Select "Hailer," then push [ENT].
  - Hailer screen is displayed.
3. Hold down [PTT] and speak at your normal voice level.
4. While holding down [PTT], the screen shown to the right is displayed.

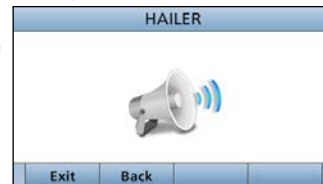

- ① Push [VOL/SQL] to open the volume adjustment screen.

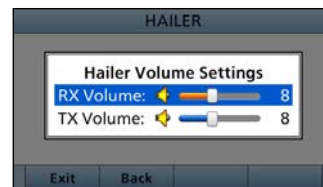



**NOTE:** While in the hailer mode, the transmit and receive functions are disabled. When the transceiver is transmitting, the hailer function is disabled.

## ■ Using the Horn

### ◇ Using the Automatic Foghorn

The Automatic Foghorn function sounds a horn repeatedly until the function is turned OFF.

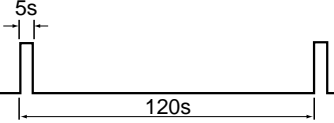
The foghorn outputs from the hailer speaker. To use this function, the hailer speaker must be connected to the transceiver. See page 94 for connection details.

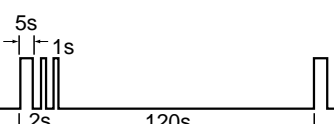
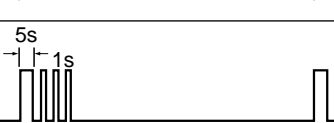
TYPE	PATTERN	USAGE
<b>UNDERWAY</b>	One 5-second blasts every 120 seconds. 	Motor vessel underway and making way.
<b>STOP</b>	Two 5-second blasts (separated by 2 seconds) every 120 seconds. 	Motor vessel underway but stopped (not making way).
<b>SAIL</b>	One 5-second blast followed by two 1-second blasts (each separated by 2 seconds) every 120 seconds. 	Sailing vessel underway, fishing vessel (underway or anchored), vessel not under command, a vessel restricted in her ability to maneuver (underway or at anchor), or a vessel towing or pushing another ahead.
<b>TOW</b>	One 5-second blast followed by three 1-second blasts (each separated by 2-seconds) every 120 seconds. 	Vessel under tow (manned).

## 9 OTHER FUNCTIONS

### ■ Using the horn

#### ◇ Using the Automatic foghorn function (Continued)

1. Push [MENU].
2. Select “Auto Foghorn:” and then push [ENT].  
(Horn > **Auto Foghorn:**)
3. Select the foghorn pattern, then push [ENT].



4. Rotate [CH/ENT] to adjust the foghorn level.



5. Push [Exit] to return to the Main screen.
  - The “” icon is displayed.

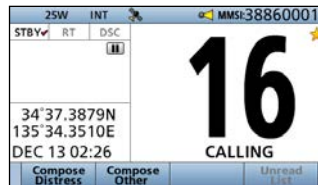

- ① To turn OFF the Auto Foghorn, select “Off” in the “Auto Foghorn:” menu.



### ◇ Manual Horn function

1. Push [MENU].
2. Select “Manual Horn” then push [ENT].  
(Horn > **Manual Horn:**)
3. Hold down [Horn] to sound a horn.
  - While holding down [Horn], the horn sounds, and the screen shown to the right is displayed.
  - To adjust the horn volume level, rotate dial.

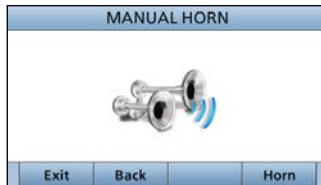

4. Push [EXIT] to return to the Main screen.

**NOTE:** While in the Horn mode, the transmit and receive functions are disabled. When the transceiver is transmitting, the Horn function is disabled.

## ■ Using the Voice Scrambler

The Voice Scrambler provides private communications. In order to receive or send scrambled transmissions, you must activate the scrambler function. You also need to set the scrambler code in the Menu screen. (p. 90)

The scrambler function automatically turns OFF when Channel 16 or 70 is selected.

1. Select an operating channel other than Channel 16, 70 or the weather channels.
2. Push [◀] or [▶] until [SCBL] is displayed in the Software Key area.
3. Push [SCBL]  to turn the Voice Scrambler ON or OFF.
  - The “SBL” icon is displayed when the voice scrambler is ON.



### ◇ Setting scrambler codes

Set the code to between 1 and 32 in the Menu screen. In order to understand each other, all transceivers in your group must use the same scramble code.

## 9 OTHER FUNCTIONS

### ■ Using the Voice Recorder

The transceiver has an automatic recording function that can record the last 120 seconds of the receiving audio. You can playback the audio that you could not hear clearly.

- Starts recording automatically when the signal is received.
- The “” icon is displayed while recording.
- Stops recording 3 seconds after the signal disappears.
- Stops recording when the channel is changed.
- The recorded voice data is erased when the transceiver is turned OFF.



### ◇ Playback the recorded voice

- Push [RX Play] to playback the recorded voice.
  - The “” icon is displayed while playing.
- Push [Stop] to stop playing back the recorded voice.



## ■ About AIS

The Automatic Identification System (AIS) is primarily used for collision-risk management and navigation safety. It automatically transmits and receives vessel information, such as the vessel name, MMSI code, vessel type, position data, speed, course, destination and more. Information is exchanged among the vessels and/or base stations on the VHF maritime mobile band. The information helps to identify other nearby vessels or stations by displaying the received data on a plotter or a radar screen.

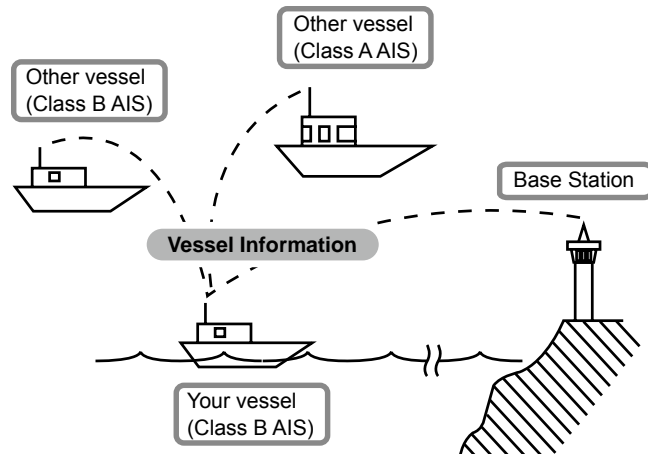

## ■ AIS Classes

There are 7 types of AIS stations, vessels, base stations, Search and Rescue (SAR), Aids to Navigation (AtoN), Search and Rescue Transmitter (AIS-SART), Man OverBoard (MOB), and Emergency Position Indicating Radio Beacon-AIS (EPIRB-AIS).

There are 2 classes of AIS units, which are installed on vessels, Class A and Class B.

Under the Safety Of Life At Sea (SOLAS) convention, all SOLAS vessels, as described below, are required to install a Class A AIS transponder:

- Upwards of 300 gross tonnage engaged on international voyages.
- Passenger vessels, irrespective of size, engaged on international voyages.
- Upwards of 500 gross tonnage not engaged on international voyages.

A Class B AIS transponder is designed to be interoperability with Class A units, but not to impact the Class A network. Many commercial vessels, and some leisure craft, not classified as requiring a Class A unit, choose to install a Class B unit to avoid accidents at sea.

## 10 AIS RECEIVER

### ■ Function display

There are 3 types of function displays, plotter, target list and danger list. Select the display type using the [Display] key.

1. Push [MENU].
2. Select "AIS" then push [ENT].
  - The Plotter screen is displayed.

#### ◇ Plotter screen

If the GPS is connected and it receives signals from a satellite, the plotter screen shows the display range and the icons of the AIS targets.

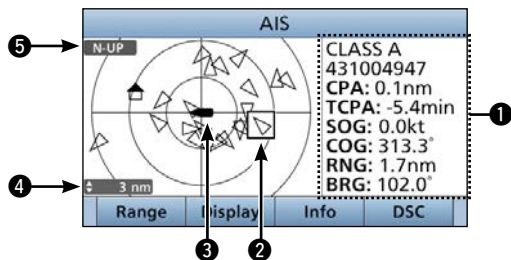

#### ① INFORMATION

Displays the selected target's information.

#### ② TARGET BOX

Displays the selected AIS target.

- ① When a target box is displayed, push [ENT] to display the detail screen of the selected AIS target.

#### ③ YOUR VESSEL ICON

Displayed in the center of the screen.

- ① When "N-UP" is displayed, the vessel icon automatically points in the direction you are heading, in 45 degrees steps.
- ① When "COG-UP" is displayed, the vessel icon constantly points to the top of the plotter screen.
- ① When your vessel moves less than 2 knots, the "●" icon is displayed.

#### ④ DISPLAY RANGE

Displays the selected display range.

Push [Range] to select display range.







- ① 0.125, 0.25, 0.5, 0.75, 1.5, 3, 6, 12, 24 nm (nautical miles) are selectable.

#### ⑤ DISPLAY TYPE

Displays the selected display type. You can select the display type from the menu screen (p. 80).

- ① When "N-UP" is displayed, the top of the plotter screen represents North.
- ① When "COG-UP" is displayed, the top of the plotter screen represents the direction your course is heading.

• Description of the icons

Icon	Description
	AIS target: Vessel The tip of the target triangle automatically points in the direction it's heading. The icon blinks when the AIS target is closer than your CPA and TCPA settings. (Dangerous target)
	AIS target: Lost target* The target triangle is marked with a diagonal line.
	AIS target: Base Station
	AIS target: Search and Rescue (SAR)
	AIS target: Aids to Navigation (AtoN)
	AIS target: AIS-SART, MOB and EPIRB-AIS

\*A vessel is regarded as a "Lost target" after a specified period of time has passed since the vessel last transmitted data.  
The "Lost target" icon disappears from the plotter screen 6 minutes and 40 seconds after the vessel was regarded as a "Lost target."  
Ask your dealer for details.

◇ Target list screen

In the plotter screen, push [Display]  to enter the target list screen, which shows all AIS targets being detected by the transponder.

The AIS target data is sorted by the distance from your vessel, and the closest target is located at the top of the list.

- ① Rotate [CH/ENT] to select an AIS target.
- ② Push [INFO] to display the detail screen of the selected AIS target. (p. 76)
- ③ Push [DSC] to transmit DSC call to selected AIS target.

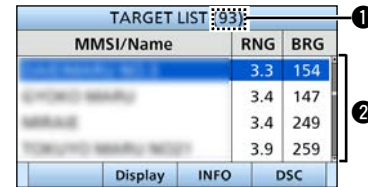

① THE NUMBER OF TARGETS

Displays the number of AIS targets which are being detected by the transceiver.

② TARGET INFORMATION

Displays the following AIS target information:

- MMSI code or name.
- Range (RNG) from your vessel to the target (unit: nautical mile).
- Bearing (BRG) from your vessel to the target (unit: degree).

## 10 AIS RECEIVER

### ◇ Danger list screen

In the target list display, push [Display]  to switch to the danger list screen, which helps you to find any dangerous target whose CPA is within 6 nm (nautical miles) and TCPA is within 60 minutes of your vessel.

- Rotate [CH/ENT] to select an AIS target.
- Push [INFO] to display the detail screen of the selected AIS target.
- Push [DSC] to transmit DSC call to selected AIS target.

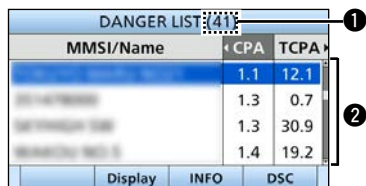

MMSI/Name	CPA	TCPA
	1.1	12.1
	1.3	0.7
	1.3	30.9
	1.4	19.2

#### ① THE NUMBER OF DANGEROUS TARGETS

Displays the number of AIS targets which are being detected by the transceiver.

#### ② DANGER TARGET INFORMATION

Displays the following dangerous target information:

- MMSI code or name.
- CPA: Closest Point of Approach (unit: nautical mile).
- TCPA: Time to CPA (unit: minute).

### ■ About the detail screen

The detail screen displays the information about the selected AIS target. The contents differ, depending on the AIS class.

1. Select an AIS target in the target list screen, danger list screen, or plotter screen then push [INFO] or [ENT].
  - The detail screen is displayed.
  - Rotate [CH/ENT] to scroll the page.

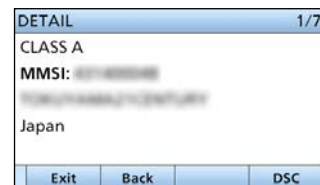

DETAIL 1/7		
CLASS A		
MMSI: 676010000		
Japan		
Exit	Back	DSC

### ◇ Content lists of Class A vessels' DETAIL screens

- AIS Class
- MMSI Code
- Ship Name
- Country Name
- Call Sign
- IMO Number
- CPA (Closest Point of Approach)
- TCPA (Time to CPA)
- Position (Latitude, Longitude)
- Speed Over Ground
- Course Over Ground
- Heading
- Position Accuracy (H: High, L: Low)
- Range
- Bearing
- Rate Of Turn
- Bow to Antenna length
- Stern to Antenna length
- Port side to Antenna length
- Starboard side to Antenna length
- Length
- Beam
- Draught
- Type of Ship
- Navigation Status
- Destination
- Date
- Time

### ◇ Content lists of Class B vessels' DETAIL screens

- AIS Class
- MMSI Code
- Ship Name
- Country Name
- Call Sign
- Vendor ID
- CPA (Closest Point of Approach)
- TCPA (Time to CPA)
- Position (Latitude, Longitude)
- Speed Over Ground
- Course Over Ground
- Heading
- Position Accuracy (H: High, L: Low)
- Range
- Bearing
- Bow to Antenna length
- Stern to Antenna length
- Port side to Antenna length
- Starboard side to Antenna length
- Length
- Beam
- Type of Ship

### ◇ Content lists of Base Station targets' DETAIL screens

- AIS Class
- MMSI Code
- Position (Latitude, Longitude)
- Position Accuracy (H: High, L: Low)
- Range
- Bearing

---

## 10 AIS RECEIVER

### ◇ Content lists of SAR targets' DETAIL screens

- AIS Class
- MMSI Code
- Position (Latitude, Longitude)
- Speed Over Ground
- Course Over Ground
- Position Accuracy (H: High, L: Low)
- Range
- Bearing
- Altitude

### ◇ Content lists of AtoN targets' DETAIL screens

- AIS Class (AtoN existence (REAL, VIRTUAL))
- MMSI Code
- Target Name
- CPA (Closest Point of Approach)
- TCPA (Time to CPA)
- Position (Latitude, Longitude)
- Position Accuracy (H: High, L: Low)
- Range
- Bearing
- Bow to Antenna length
- Stern to Antenna length
- Port side to Antenna length
- Starboard side to Antenna length
- Length
- Beam
- Position Indicator (ON POS : ON Position, OFF POS : OFF Position)
- Type of AtoN

### ◇ Content lists of AIS-SART targets' DETAIL screens

- Type of AIS Target
- MMSI Code
- Call Sign
- IMO Number
- Closest Point of Approach
- TCPA (Time to CPA)
- Position (Latitude, Longitude)
- Speed Over Ground
- Course Over Ground
- Heading
- Position Accuracy (H: High, L: Low)
- Range
- Bearing
- Rate Of Turn
- Bow to Antenna length
- Stern to Antenna length
- Port side to Antenna length
- Starboard side to Antenna length
- Length
- Beam
- Draught
- Type of Ship
- Navigation Status
- Destination
- Date
- Time



### ◇ Content lists of MOB targets' DETAIL screens

- Type of AIS Target
- MMSI Code
- Call Sign
- IMO Number
- Closest Point of Approach
- TCPA (Time to CPA)
- Position (Latitude, Longitude)
- Speed Over Ground
- Course Over Ground
- Heading
- Position Accuracy (H: High, L: Low)
- Range
- Bearing
- Rate Of Turn
- Bow to Antenna length
- Stern to Antenna length
- Port side to Antenna length
- Starboard side to Antenna length
- Length
- Beam
- Draught
- Type of Ship
- Navigation Status
- Destination
- Date
- Time

### ◇ Content lists of EPIRB-AIS targets' DETAIL screens

- Type of AIS Target
- MMSI Code
- Call Sign
- IMO Number
- Closest Point of Approach
- TCPA (Time to CPA)
- Position (Latitude, Longitude)
- Speed Over Ground
- Course Over Ground
- Heading
- Position Accuracy (H: High, L: Low)
- Range
- Bearing
- Rate Of Turn
- Bow to Antenna length
- Stern to Antenna length
- Port side to Antenna length
- Starboard side to Antenna length
- Length
- Beam
- Draught
- Type of Ship
- Navigation Status
- Destination
- Date
- Time

# 10 AIS RECEIVER

## ◇ AIS combo screen

You can display the AIS plotter during basic operation.

- Push [AIS] to display the AIS plotter on the left side of the screen.
- Rotate [CH/ENT] to select an operating channel.
- Push [◀/▶] to select a vessel.
- Push [Range]  to select display range.
- Push [CLR] to exit the AIS combo screen.

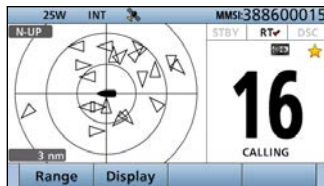

## ■ AIS Settings

AIS settings can be customized from “AIS Settings” on the menu screen.

1. Push [MENU].
2. Select “AIS SET,” then push [ENT].

### ◇ North up/COG UP:

Select the display type for the AIS plotter.

- ① When “N-UP” is displayed, the top of the plotter display represents North.
- ① When “COG-UP” is displayed, the top of the plotter display represents the direction your course is heading.
- Push [EXIT] to return to the Main screen.
- Push [BACK] to return to the previous screen.

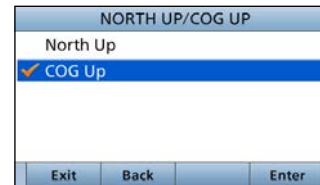

## ◇ CPA/TCPA

In this menu, you can edit alarm settings for the AIS receiver.

CPA/TCPA	
Alarm:	On ▶
Slow Warn:	1.0 kt ▶
CPA:	1.5 nm ▶
TCPA:	20 min ▶
<div style="display: flex; justify-content: space-between; width: 100%;"> <span>Exit</span> <span>Back</span> <span>Enter</span> </div>	

## • Alarm

You can turn the collision alarm function ON or OFF.

ALARM	
<input checked="" type="checkbox"/> On	
<input type="checkbox"/> Off	
<div style="display: flex; justify-content: space-between; width: 100%;"> <span>Exit</span> <span>Back</span> <span>Enter</span> </div>	

## • Slow Warn

The GPS receiver calculated COG data of a vessel that is at anchor or drifting is unreliable, and therefore the CPA and TCPA data may not be calculated correctly. If a vessel is anchored in your alarm zone, the unreliable data can cause the collision alarm to sound many times, even if there is no real danger. To prevent this, when the anchored vessel's SOG is less than this set value, the Slow Warn function assumes that vessel's COG is fixed towards your vessel and an alarm will sound.

- Rotate [CH/ENT] or push [▲]/[▼] to set the value between 0.1 and 4.9 kt (in 0.1 kt steps), or select OFF. (default: 1.0 kt)

SLOW WARN	
Slow Warn:	1.0 kt ▾
<div style="display: flex; justify-content: space-between; width: 100%;"> <span>Exit</span> <span>Back</span> <span>Enter</span> </div>	

**NOTE:** If other vessels at anchor or drifting come into your alarm zone, the Slow Warn alarm will sound again. Only if the previous vessel disappears from the Danger List (p. 76), and then re-enters the list, can a new Slow Warn or regular alarm sound, depending on the vessels SOG, or CPA and TCPA. The Slow Warn function operates in the same way if your vessel is at anchor and other vessels enter your alarm zone area.

# 10 AIS RECEIVER

## ◇ CPA/TCPA (Continued)

### • CPA, TCPA

Enter Closest Point of Approach (CPA) and Time to CPA (TCPA) values.

These settings help you find a dangerous target to avoid a collision. The icon blinks on the plotter display and/or the alarm buzzer sounds, when the AIS target is closer than your CPA and TCPA settings.

- Rotate [CH/ENT] or push [▲]/[▼] to set the value.
  - CPA: Set between 0.1 and 6.0 nm (in 0.1 nm steps) (default: 1.5 nm)
  - TCPA: Set between 1 and 60 minutes (in 1 minute steps) (default: 20 min)

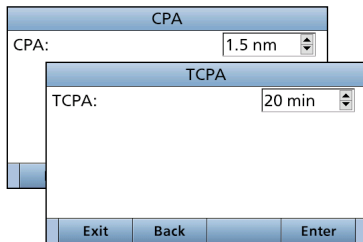

## ◇ ID BLOCKING

The transceiver blocks AIS transponders that are entered into the ID blocking list. Enter your vessel's transponder ID or other vessel's transponder IDs if necessary to prevent the transceiver from detecting them as dangerous targets. You can enter maximum of 10 transponder IDs.

### • Entering an ID

1. Push [MENU].
2. Select "ID Blocking," then push [ENT]. (AIS Settings > **ID Blocking**)
  - The blocked AIS transponder's ID is displayed.
  - "No ID" is displayed if there are no blocked AIS transponders.

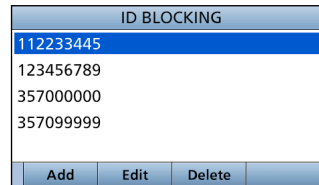



3. Push [Add] to start the ID entry.



4. Push [Finish]  to enter the ID.

**• Editing an ID**

1. Push [MENU].
2. Select "ID Blocking," then push [ENT].  
(AIS Settings > **ID Blocking**)
3. Select the ID to edit, then push [Edit] .
4. After editing, push [Finish]  to set it.

**• Deleting an ID**

1. Push [MENU].
2. Select "ID Blocking," then push [ENT].  
(AIS Settings > **ID Blocking**)
3. Select the ID to delete, then push [Delete] .

# 11 MENU ITEMS

## ■ Menu items

The Menu screen is constructed in a tree structure. (p. 11)

The following items are described in each section.  
Refer to the specified pages for details.

### ◇ Compose Distress (p. 31)

### ◇ Compose Non-Distress

- Individual call (p. 37)
- All Ships (p. 40)
- Group (p. 41)
- Test (p. 44)

### ◇ DSC Log (pp. 58, 59)

### ◇ DSC Settings (p. 60)

### ◇ AIS Settings (p. 80)

### ◇ GPS Information (p. 85)

### ◇ Configuration

item	Ref.	item	Ref.
Key Beep	p. 85	Speaker	p. 87
Key Assignment	p. 85	Noise Cancel	p. 87
UTC Offset	p. 86	Power SW from Sub Unit	p. 88
Inactivity Timer	p. 86		

### ◇ Radio Settings

item	Ref.	item	Ref.
Scan Type* <sup>1</sup>	p. 88	Voice Scrambler* <sup>3</sup>	p. 90
Scan Timer* <sup>1</sup>	p. 88	Voice Record	p. 90
Dual/Tri-Watch* <sup>1</sup>	p. 89	FAV Settings	p. 90
Channel Group	p. 89	FAV on MIC	p. 90
Call Channel	p. 89	Channel Display	p. 90
WX Alert* <sup>2</sup>	p. 89		

\*<sup>1</sup>Except for the Dutch version.

\*<sup>2</sup>For only the USA version.

\*<sup>3</sup>Displayed only when the voice scrambler unit is installed.

### ◇ NMEA Settings

item	Ref.	item	Ref.
NMEA 0183	p. 91	NMEA 2000	p. 91

### ◇ Radio Information (p. 93)

## ■ GPS Information

Displays the data received by the connected GPS receiver.

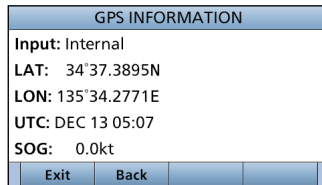

## ■ Configuration

### ◇ Key Beep

(Configuration > **Key Beep**.)

Turn the Key Beep function ON or OFF.

- On: Sounds a beep when pushing a key. (Default)
- Off: Does not sound a beep when pushing a key, for silent operation.



### ◇ Key Assignment

(Configuration > **Key Assignment**)

Assign functions to Software keys. The assigned function can be used when its key icon is displayed.

See page 4 for details of the assignable key functions.

1. Select the Software key, then push [ENT].

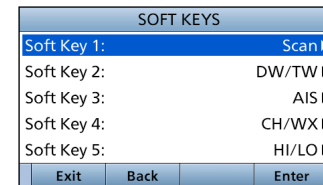

2. Select the function to assign, then push [ENT].



# 11 MENU ITEMS

## ◇ UTC Offset

(Configuration > **UTC Offset**;)

Set the offset time between Universal Time Coordinated (UTC) and your local time to between -14:00 and +14:00 (in 1 minute steps). (Default: 00:00)

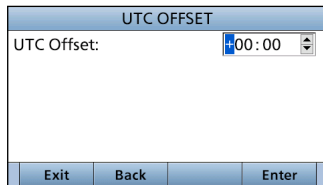

## ◇ Inactivity Timer

(Configuration > **Inactivity Timer**;)

The count down alarm sounds 10 seconds before the Inactivity Timer activates.

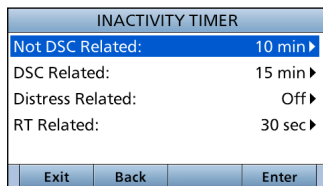

## • Not DSC Related

(Configuration > Inactivity Timer > **Not DSC Related**;)

The transceiver automatically returns to the Main screen if no key is pushed for this set period of time. (Default: 10 min)  
This setting is for when the LCD displays a screen that is not related to DSC screen other than the Main screen.

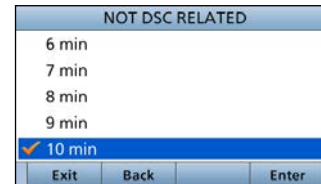

## • DSC Related

(Configuration > Inactivity Timer > **DSC Related**;)

The transceiver automatically returns to the Main screen if no key is pushed for this set period of time. (Default: 15 min)  
This setting is for when the LCD displays a screen that is related to DSC.

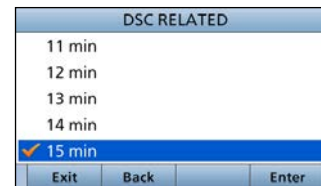



• **Distress Related**

(Configuration > Inactivity Timer > **Distress Related:**)

The transceiver automatically returns to the Main screen if no key is pushed for this set period of time. (Default: Off)  
This setting is for when the LCD displays a screen that is related to a Distress call.

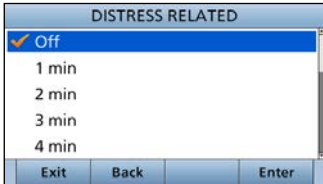

• **RT Related**

(Configuration > Inactivity Timer > **RT Related:**)

The transceiver automatically returns to the standby mode if you push no key for this set period of time. (Default: 30 sec)  
This setting is for when the transceiver is in the Radio Telephone mode.

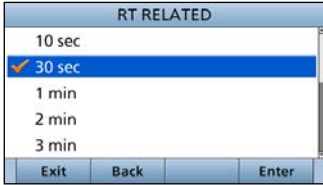

◇ **Speaker**

(Configuration > **Speaker:**)

Select the speaker to use. (Default: Internal)

Internal: The audio is heard from the internal speaker.  
Int. and ext.: The audio is heard from both the internal speaker and the external speaker.  
Confirm this item is selected, when you use the external speaker.

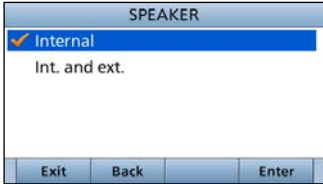

◇ **Noise Cancel**

(Configuration > **Noise Cancel**)

Set the Noise Cancel function for both receive and transmit.  
RX: The function reduces noise component in your receive audio for your smooth reception.  
TX: It is effective to turn ON the TX noise cancel function when you operate under a noisy surround area.

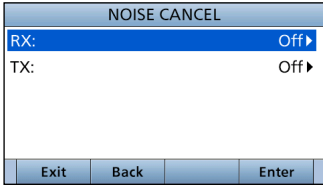

# 11 MENU ITEMS

## ◇ Power Switch from sub unit

(Configuration > **Power SW from Sub Unit:**)

Select weather or not to turn OFF the transceiver at same time that you turn OFF the command microphone or command head.

(Default: All Units)

- ① The optional HM-195 or HM-229 command microphone or RC-M600 COMMAND HEAD is required to use this function.

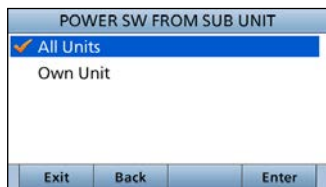

All Units: When you turn OFF the command microphone or command head, the transceiver is turned OFF at same time.

Own Unit: The transceiver is not turned OFF even if you turn OFF the command microphone or command head.

## ■ Radio Settings

### ◇ Scan Type (Except for the Dutch version)

(Radio Settings > **Scan Type**)

Select the Scan type to locate signals.

- Normal Scan: Sequentially searches all Favorite channels. (Default for the USA version.)
- Priority Scan: Sequentially searches all Favorite channels, while also monitoring Channel 16. (Default for the transceiver other than USA version.)

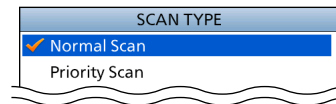

### ◇ Scan Timer (Except for the Dutch version)

(Radio Settings > **Scan Timer**)

Turn the Scan Resume timer ON or OFF.

- On: When a signal is detected on a channel, the scan pauses for 5 seconds, and then resumes. If the signal disappears in less than 5 seconds, the scan immediately resumes.
- Off: When a signal is detected on a channel, the scan pauses until the signal disappears, and then resumes. (Default)

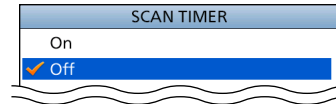

◇ **Dual/Tri-Watch**

(Except for the Dutch version)  
(Radio Settings > **Dual/Tri-Watch**)  
Select the watch type. (p. 24)

- Dualwatch: The transceiver monitors Channel 16, while listening or talking on another channel. (Default)
- Tri-watch: The transceiver monitors Channel 16 and the Call channel, while listening or talking on another channel.

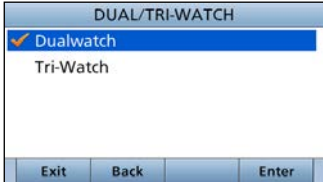

◇ **Channel Group**

(Radio Settings > **Channel Group**)  
Select a channel group suitable for your operating area. Selectable channel group and the default setting may differ depending on the transceiver version.

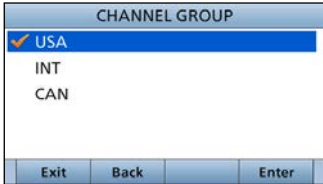

◇ **Call Channel**

(Radio Settings > **Call Channel**)  
You can set the Call channel with your most often-used channel for quick recall. (p. 14) (Default: Channel 16)

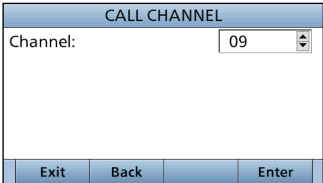

◇ **Weather Alert**

(For only the USA version.)  
(Radio Settings > **WX Alert**.)

A NOAA broadcast station transmits a weather alert tone before important weather information. After the transceiver detects the alert, "WX" blinks until the transceiver is operated.

① "WX"  displayed instead of "WX" when the function is set to "On."

(Default: "Off")

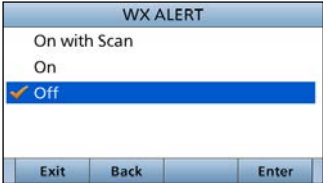

# 11 MENU ITEMS

## ◇ Voice Scrambler

(Displayed only when a Voice scrambler unit is installed.)

(Radio Settings > **Voice Scrambler**:)

Set the Voice Scrambler code to between 1 and 32.

In order to understand each other, all transceivers in your group must use the same scramble code, as well as the same scrambler unit.

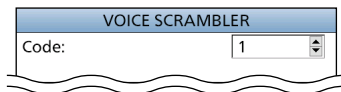

## ◇ Voice Record

(Radio Settings > **Voice Record**:)

You can disable the Voice recorder (p. 72) by selecting "Off."

(Default: Auto (Last 120 sec))

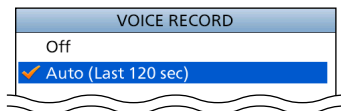

## ◇ FAV Settings

(Radio Settings > **FAV Settings**)

Set the Favorite channel settings.

- Set All Channels: Sets all channels as Favorite channels.
- Clear All Channels: Clears all Favorite channels.
- Set Default: Returns to the default setting.

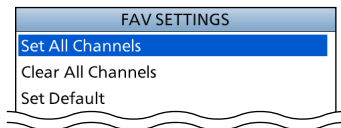

## ◇ FAV on MIC

(Radio Settings > **FAV on MIC**)

Turn the FAV on MIC function ON or OFF.

- On: Pushing [▲] or [▼] on the supplied microphone scrolls up and down through only the Favorite channels. (Default)
- Off: Pushing [▲] or [▼] on the supplied microphone scrolls up and down through all channels.



## ◇ Channel Display

You can select the number of digits to display the channel number. (Default: 4 digits)

- 3 digits: The channel number is displayed in 3 digits, such as "01A."
  - 4 digits: The channel number is displayed in 4 digits, such as "1001."
- ① This setting may not be usable, depending on the presetting.

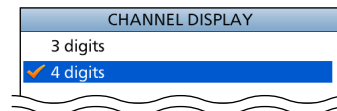

## ■ NMEA Settings

### ◇ NMEA 0183

(NMEA Settings > **NMEA 0183**)

Select the data transfer speed for each port to receive data from external devices.

- 4800 bps: Select to receive position data from an external GPS receiver.
- 38400 bps: Select to receive AIS data from an external AIS transponder.

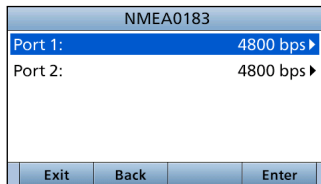

### ◇ NMEA 2000

(NMEA Settings > **NMEA 2000**)

NMEA 2000 is a communication standard used to connect various marine devices and display units in the vessel. The transceiver can easily connect to a NMEA 2000 network with its plug-and-play functionality, and display the information provided from the devices on the network. Select the sensors in NMEA 2000 network which sends data to the transceiver.

1. Push [MENU].
2. Select "NMEA 2000," then push [ENT].  
(NMEA Settings > **NMEA 2000**)
3. Select the type of data from the menu screen and push [ENT].

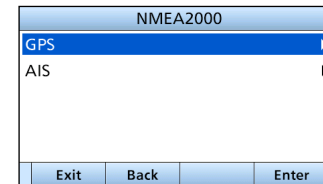

# 11 MENU ITEMS

## ■ NMEA Settings

### ◇ NMEA 2000 (Continued)

- The transceiver starts searching the devices connected to NMEA 2000 network.

① Push [Stop Searching] to stop searching devices and display the device list.

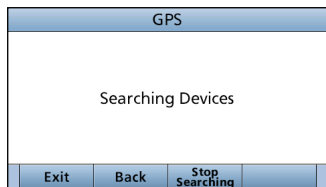

- The list of connected device is displayed.
- Select the device to send the data to the transceiver, and push [ENT].
  - Push [INFO] to display the detail of device.
  - If the transceiver is connected to both NMEA 0183 and NMEA 2000 devices, the NMEA 2000 device has priority. Select "Not Used" if you want to use NMEA 0183 devices.

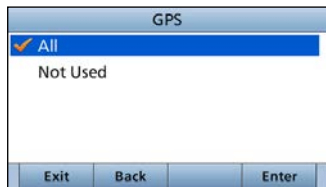

- Push [EXIT] to return to the Main screen.

## ◇ Compatible PGN list

Receive	
060160	ISO Transport Protocol, Data Transfer
060416	ISO Transport Protocol, Connection Management
065240	ISO Commanded Address
059392	ISO Acknowledgement
059904	ISO Request
060928	ISO Address Claim
126208	NMEA - Request/Command Group Function
126996	Product Information
129026	COG (Course Over Ground) and SOG (Speed Over Ground) - Rapid Update
129029	GNSS (Global Navigation Satellite System) Position Data
129038	AIS Class A Position Report
129039	AIS Class B Position Report
129040	AIS Class B Extended Position Report
129041	AIS Aids to Navigation (AtoN) Report
129793	AIS UTC and Date Report (Base Station)
129794	AIS Class A Static and Voyage Related Data
129798	AIS SAR Aircraft Position Report
129809	AIS Class B "CS" Static Data Report, Part A
129810	AIS Class B "CS" Static Data Report, Part B

## ■ Radio Information

Displays your transceiver's information as shown below.

Transmit	
060416	ISO Transport Protocol, Connection Management
059392	ISO Acknowledgement
059904	ISO Request
060928	ISO Address Claim
126208	NMEA - Acknowledge Group Function
126993	Heartbeat
126998	Configuration Information
129539	GNSS DOPs
129540	GNSS Sats in View
126464	PGN List
126996	Product Information
129026	COG (course over ground) and SOG (speed over ground) - Rapid Update
129029	GNSS (Global Navigation Satellite System) Position Data
129799	Radio Frequency/Mode/Power
129808	DSC Call Information
129038	AIS Class A Position Report
129039	AIS Class B Position Report
129040	AIS Class B Extended Position Report
129041	AIS Aids to Navigation (AtoN) Report
129793	AIS UTC and Date Report (Base Station)
129794	AIS Class A Static and Voyage Related Data
129798	AIS SAR Aircraft Position Report
129809	AIS Class B "CS" Static Data Report, Part A
129810	AIS Class B "CS" Static Data Report, Part B

RADIO INFORMATION			
MMSI: 388600015			
Serial No.:			
Main: 1.000			
Sub: 1.000			
NMEA2000: 1.000			
Exit	Back		

# 12 CONNECTIONS AND MAINTENANCE

## ■ Connections

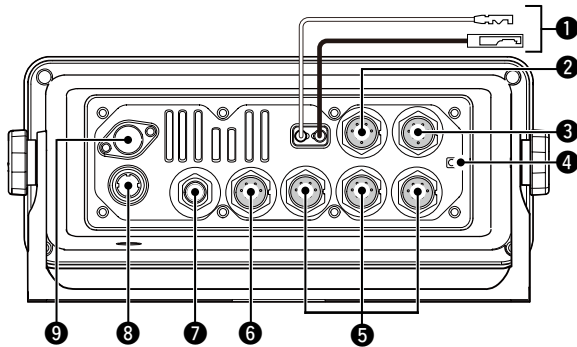

### 1 DC POWER CONNECTOR

Connects to a 13.8 V DC power source. (+: Red, -: Black)

**CAUTION:** After connecting the DC power cable, NMEA leads, external speaker leads and Hailer leads, cover the connector and leads with an adhesive tape, as shown below, to prevent water seeping into the connection.

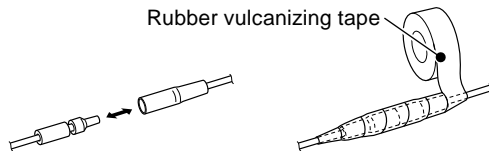

### 2 MICROPHONE CONNECTOR

Connects the supplied or optional HM-205 microphone.\*  
\*Not usable when the microphone is connected to the connector on the front panel.

### 3 EXTERNAL SPEAKER CONNECTOR

Connects the optional SP-37 HORN SPEAKER.



Transceiver's rear panel view

### 4 GROUND TERMINAL

Connects to a vessel ground to prevent electrical shocks and interference from other equipment occurring. Use a self tapping screw (3 x 6 mm: not supplied).

### 5 COMMAND MICROPHONE/ COMMAND HEAD CONNECTOR

Connects the optional command microphone\* or command head.

\*OPC-2384 CONVERSION CABLE is required.

### 6 NMEA 0183 CONNECTORS

- Connects to NMEA 0183 Out lines of a PC or NMEA 0183 sentence format DSC or DSE compatible navigation equipment, to receive position data from other ships.



- Connects to NMEA 0183 In lines of a GPS receiver for position data.
  - A GPS receiver compatible with NMEA 0183 format RMC, GGA, GNS, or GLL and VTG sentences is required. Ask your dealer about suitable GPS receivers.



Transceiver's rear panel view

**7 NMEA 2000 CONNECTOR**

Connects to the NMEA 2000 network.

**8 GPS ANTENNA CONNECTOR**

Connects the supplied GPS antenna.

**NOTE:** Be sure the GPS antenna is positioned where the GPS antenna has a clear view to receive signals from satellites.

**9 ANTENNA CONNECTOR**

Connects to a marine VHF antenna with a PL-259 connector.

**CAUTION: DO NOT** transmit without an antenna.

◇ **NMEA 0183 In/Out lines specifications**

PIN	SPECIFICATIONS
NMEA 0183 OUT (+)	Output level: 5 V/40 mA maximum (RS-422 balanced type)
NMEA 0183 OUT (-)	
NMEA 0183 IN (+)	Input level: Less than 2 mA (at 2 V applied)
NMEA 0183 IN (-)	

◇ **Connecting the MA-500TR**

For the transceiver without a built-in AIS receiver, connect the transceiver to the high density D-Sub 15-pin connector of the MA-500TR using the OPC-2014\* cable.

\* The OPC-2014 is supplied with the MA-500TR

- **NMEA 1 OUT (+) or NMEA 2 OUT(+):**  
Connects to lead 3 of the OPC-2014.
- **NMEA 1 OUT (-) or NMEA 2 OUT(-):**  
Connects to lead 2 of the OPC-2014.
- **NMEA 1 IN (+) or NMEA 2 IN (+):**  
Connects to lead 5 of the OPC-2014.
- **NMEA 1 IN (-) or NMEA 2 IN (-):**  
Connects to lead 4 of the OPC-2014.

## 12 CONNECTIONS AND MAINTENANCE

### ■ Connections (Continued)

#### ◇ Connecting the RC-M600

The RC-M600 COMMAND HEAD has the same front panel as the transceiver. Connect the RC-M600 using the OPC-2383 CONTROL CABLE. You can operate the transceiver from the distance.

1. Connect the OPC-2383's 12-pin connector to the transceiver's command microphone/command head connector.
2. Connect the other side of OPC-2383 to the RC-M600's 10-pin connector.
3. Connect to a 13.8 V DC power source using the DC power cable supplied with the command head.
4. Connect the external speaker through the supplied 2-pin connector.

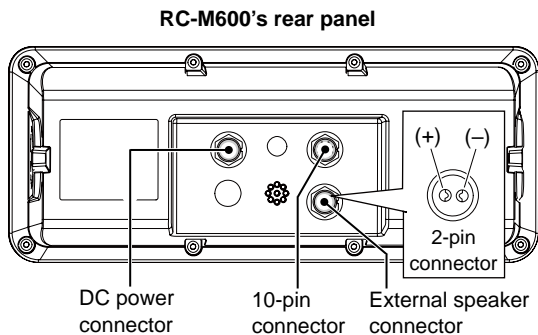

### ■ Antenna

A key element in the performance of any communication system is the antenna. Ask your dealer about antennas and the best place to mount them.

### ■ Fuse replacement

One fuse is installed in the supplied DC power cable. If the fuse blows, track down the source of the problem, repair it, and replace the damaged fuse with a new one of the proper rating.

Fuse rating: 10 A

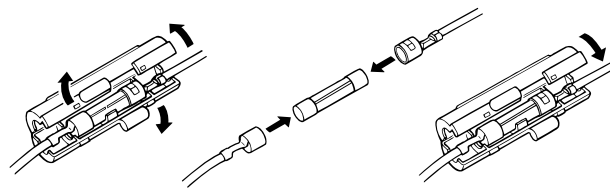

### ■ Cleaning

If the transceiver becomes dusty or dirty, wipe it clean with a soft, dry cloth.



**DO NOT** use harsh solvents such as Benzine or alcohol, as they will damage transceiver's surfaces.

# ■ Supplied accessories

Mounting bracket

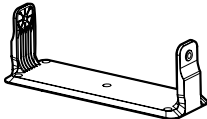

- For the mounting bracket
- |                       |                         |
|-----------------------|-------------------------|
| Knob bolts<br>        | Flat washers (M5)<br>   |
| Screws (M5x20 mm)<br> | Spring washers (M5)<br> |
| Screws (5x20 mm)<br>  | Nuts (M5)<br>           |

Microphone

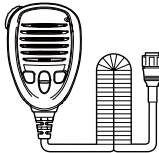

- |             |                                      |
|-------------|--------------------------------------|
| Sponges<br> | Accessory connectors<br>6-pin  8-pin |
|-------------|--------------------------------------|

Microphone hanger and screws (3x16 mm)



- |                                  |                       |
|----------------------------------|-----------------------|
| DC power cable (OPC-1174A)*1<br> | Warning sticker*2<br> |
|----------------------------------|-----------------------|

GPS antenna



- |                                   |
|-----------------------------------|
| Conversion cable (OPC-2384)*3<br> |
|-----------------------------------|

\*1 Used for the transceiver's operation check. (12 V DC only)  
 \*2 For only the USA version.  
 \*3 May not be supplied, depending on the transceiver version.

## ◇ Accessory connectors set up

The accessory connectors are used on the accessory cables.

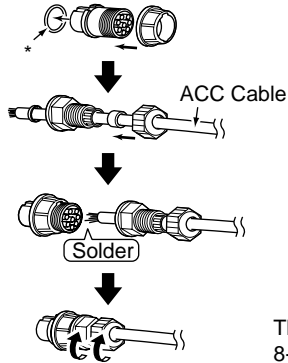

These illustrations are for the 8-pin connector.

\* Be sure to set this ring to keep the waterproof capability.

## 12 CONNECTIONS AND MAINTENANCE

### ■ Mounting the transceiver

The universal mounting bracket supplied with your transceiver enables overhead or flat mounting.

- Mount the transceiver securely with the 5 supplied (M5 × 20) screws to a surface that is more than 10 mm thick and can support more than 5 kg.
- Mount the transceiver so its face is at 90° to your line of sight when operating.

**CAUTION:** Keep the transceiver and microphone at least 1 meter (3.3 feet) away from your vessel's magnetic navigation compass.

**NOTE:**

- Check the installation angle. The function display may not be easy to read at some angles.
- When mounting the transceiver on the place that is prone to strong vibration, use the supplied sponges between the transceiver and mounting bracket to reduce the vibration.

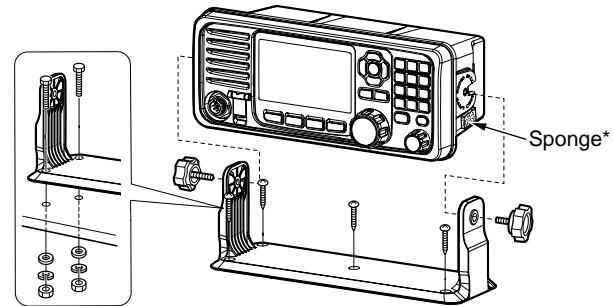

\*Sponges reduce the vibration effects.  
See NOTE shown to the left.

## ■ MB-132 installation

An optional MB-132 FLUSH MOUNT KIT is used to mount the transceiver to a flat surface such as an instrument panel.

**CAUTION:** Keep the transceiver and microphone at least 1 meter (3.3 feet) away from your vessel's magnetic navigation compass.

1. Using the template comes with the transceiver, carefully cut a hole in the instrument panel, or wherever you plan to mount the transceiver.
2. Slide the transceiver through the hole.

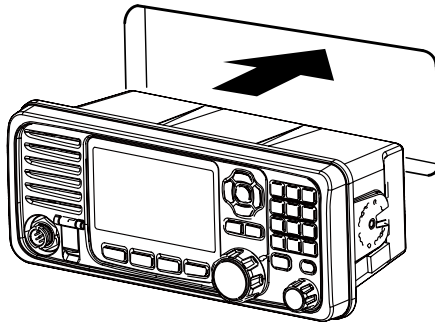

3. Attach clamps on both sides of the transceiver using 2 supplied (M5 × 8 mm) bolts.
  - ① Make sure that the clamps align parallel to the transceiver's body.

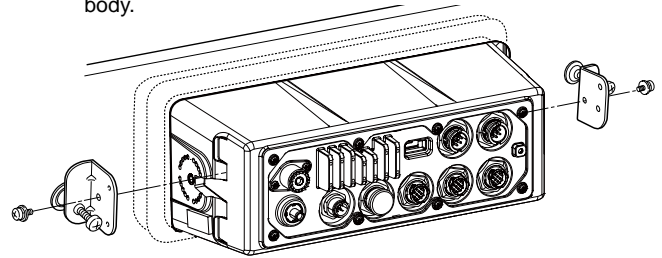

4. Tighten the end bolts on the clamps (rotate clockwise) so that they press firmly against the inside of the instrument control panel (4). (Torque: 0.6 N•m)
5. Tighten the locking nuts (rotate counterclockwise) so that the transceiver is securely mounted in position, as shown below (5).
6. Connect the antenna and power cable, then return the instrument control panel to its original place.

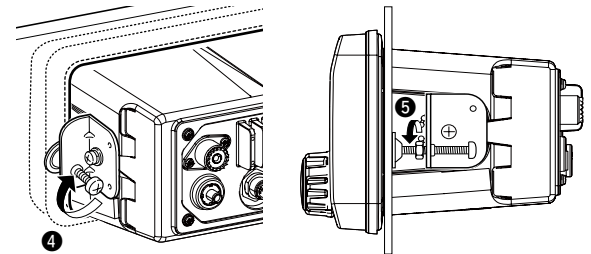

## 12 CONNECTIONS AND MAINTENANCE

### ■ Microphone installation

Connect the optional HM-195\*<sup>1</sup> or HM-229 to the transceiver using the supplied OPC-2384 CONVERSION CABLE\*<sup>2</sup> and the OPC-1540 CONNECTION CABLE that comes with the microphone.

\*<sup>1</sup> Not usable for the IC-M605EURO.

\*<sup>2</sup> May not be supplied, depending on the transceiver version.

① To operate from even longer distances, connect the optional 6 meter long OPC-1541 MICROPHONE EXTENSION CABLE between the OPC-2384 and the OPC-1540. Up to two OPC-1541 can be added.

You can also install the cable connector as a built-in plug on a cabinet or wall.

**NOTE:** The firmware of HM-195/HM-229 may be update when you connect them to the transceiver.

#### ◇ Installation

1. Connect the OPC-2384 and OPC-1540.
2. Connect the other side of the OPC-2384 to the command microphone connector, and tighten the nut.
3. To use the cable connector as a wall socket, install it as shown below.
4. Using the mounting base as a template, carefully mark the holes where the cable and 3 screws will be fastened.
5. Drill holes at these marks.
6. Install the mounting base using the supplied screws, as shown below.

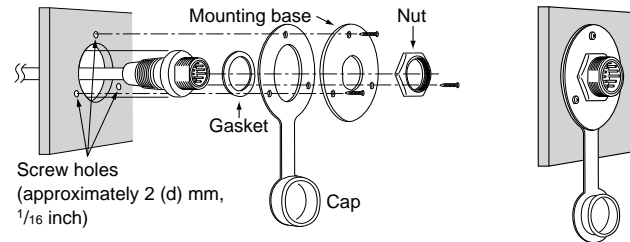

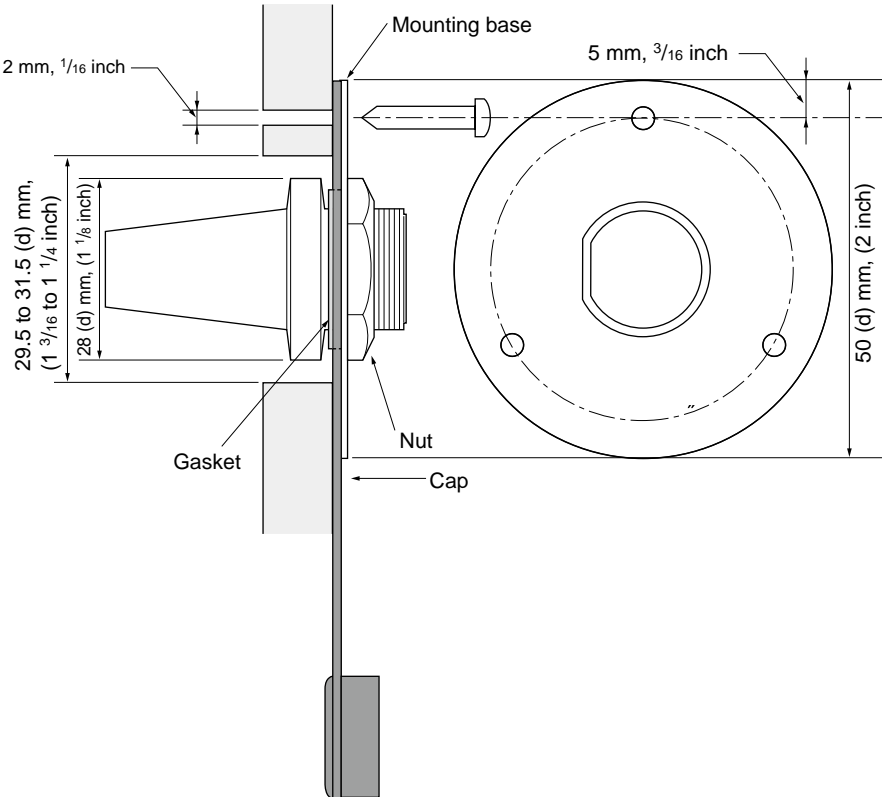

# 13 SPECIFICATIONS AND OPTIONS

## ■ Specifications

### IC-M605

#### ◇ General

- Frequency coverage: TX 156.025 ~ 161.600 MHz  
RX 156.050 ~ 163.275 MHz  
156.525 MHz (CH70/DSC)
- Mode: FM (16K0G3E), DSC (16K0G2B)
- Operating temperature range: -20°C ~ +60°C (-4°F ~ +140°F)
- Current drain: TX high (25 W) 6.0 A maximum  
RX Maximum audio 8.0 A\*
- Power supply requirement: 13.8 V DC nominal (negative ground)
- Frequency stability: ±5 ppm
- Antenna impedance: 50 Ω nominal
- Dimensions  
(projections not included): 274 (W) × 114 (H) × 121.5 (D) mm  
10.8 (W) × 4.5 (H) × 4.8 (D) inches
- Weight (approximately): 1.5 kg, 3.3 lb

\*When options (3 command microphones, hailer speaker, and external speaker) are connected.

#### ◇ Transmitter

- Output power: 25 W or 1 W
- Modulation system: Variable reactance frequency modulation
- Maximum frequency deviation: ±5 kHz
- Spurious emissions: Less than -70 dBc (High)  
Less than -56 dBc (Low)
- Adjacent channel power: More than 70 dB

- Audio harmonic distortion: Less than 10% (at 60% deviation)
- Residual modulation: More than 40 dB
- Audio frequency response: +1 ~ -3 dB of 6 dB/octave range from 300 Hz to 2500 Hz

#### ◇ Receiver

- Receive system: Double conversion superheterodyne
- Sensitivity:  
FM: -13 dBμ (typical) (12 dB SINAD)  
DSC (CH70): -3 dBμ emf (typical) (1% BER)
- Squelch sensitivity: Less than -7 dBμ
- Intermodulation:  
FM: More than 80 dB  
DSC (CH70): More than 73 dBμ emf (1% BER)
- Spurious response:  
FM: More than 77 dB  
DSC (CH70): More than 73 dBμ emf (1% BER)
- Adjacent channel selectivity:  
FM: More than 80 dB  
DSC (CH70): More than 80 dBμ emf (1% BER)
- Audio output power: More than 15 W at 10% distortion into a 4 Ω load
- Ham and noise: More than 40 dB
- Audio frequency response: +1 ~ -3 dB of -6 dB/octave range from 300 Hz to 3000 Hz

All stated specifications are subject to change without notice or obligation.



**IC-M605EURO****(According to EN301 025)****◇ General**

- Frequency coverage: TX 156.000 ~ 161.600 MHz  
RX 156.000 ~ 163.425 MHz  
156.525 MHz (CH70/DSC)
- Mode: FM (16K0G3E), DSC (16K0G2B)
- Operating temperature range:  $-20^{\circ}\text{C} \sim +60^{\circ}\text{C}$
- Current drain: TX high (25 W) 6.0 A maximum  
RX Maximum audio 8.0 A\*
- Power supply requirement: 13.8 V DC nominal (negative ground)
- Frequency error: Less than  $\pm 0.5$  kHz
- Antenna impedance: 50  $\Omega$  nominal
- Dimensions  
(projections not included): 274 (W)  $\times$  114 (H)  $\times$  121.5 (D) mm
- Weight (approximately): 1.5 kg

\*When options (3 command microphones, hailer speaker, and external speaker) are connected.

**◇ Transmitter**

- Output power: 25 W or 1 W
- Modulation system: Variable reactance frequency modulation
- Maximum frequency deviation:  $\pm 5$  kHz
- Spurious emissions: Less than 0.25  $\mu\text{W}$
- Adjacent channel power: More than 70 dB
- Audio harmonic distortion: Less than 10% (at 60% deviation)
- Residual modulation: More than 40 dB
- Audio frequency response:  $+1 \sim -3$  dB of 6 dB/octave range from 300 Hz to 3000 Hz

**◇ Receiver**

- Receive system: Double conversion superheterodyne
- Sensitivity: FM:  $-5$  dB $\mu$  emf (typical) (20 dB SINAD)  
DSC (CH70):  $-3$  dB $\mu$  emf (typical) (1% BER)
- Squelch sensitivity: Less than  $-2$  dB $\mu$  emf
- Intermodulation: FM: More than 75 dB  
DSC (CH70): More than 73 dB $\mu$  emf (1% BER)
- Spurious response: FM: More than 75 dB  
DSC (CH70): More than 73 dB $\mu$  emf (1% BER)
- Adjacent channel selectivity: FM: More than 75 dB  
DSC (CH70): More than 80 dB $\mu$  emf (1% BER)
- Audio output power: More than 15 W at 10% distortion into a 4  $\Omega$  load
- Hum and noise: More than 40 dB
- Audio frequency response:  $+1 \sim -3$  dB of  $-6$  dB/octave range from 300 Hz to 3000 Hz

# 13 SPECIFICATIONS AND OPTIONS

## ◇ Dimensions

Unit: mm (inch)

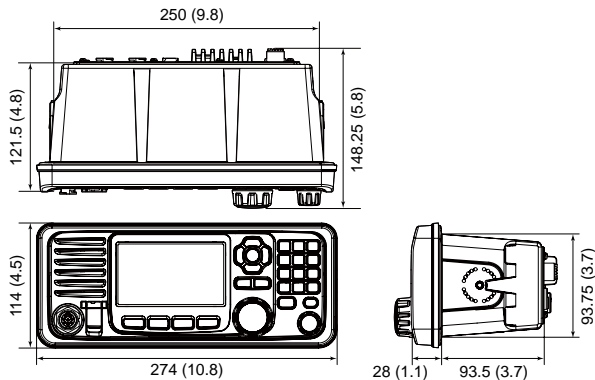

## ■ Options

### ◇ Command head and cables

#### • RC-M600 COMMAND HEAD

The command head with the same front panel as the transceiver. Mounting bracket, microphone, and a 10 meter (32.8 feet) connection cable included.

#### • OPC-2383 CONTROL CABLE\*

10 meter (32.8 feet) cable to connect the transceiver and RC-M600 COMMAND HEAD.

\*The same cable as the cable supplied with RC-M600.

#### • OPC-2377 EXTENSION CABLE

10 meter (32.8 feet) extension cable.

### ◇ Microphone and cables

#### • HM-195GB/HM-195GW COMMANDMICIV™\*

External microphone-type controller. Provides optional intercom operation. 6 meters (20 feet) microphone cable and mounting base included.

HM-195GB: Black

HM-195GW: White

\*Not usable for the IC-M605EURO.

#### • HM-229B/HM-229W COMMANDMICV™

External microphone-type controller without [DISTRESS] key.

HM-229B: Black

HM-229W: White

- **OPC-2384** CONVERSION CABLE

The cable to connect the transceiver and HM-195 or HM-229.

- **OPC-1541** MICROPHONE EXTENSION CABLE

6 meters (20 feet) microphone extension cable for optional HM-195 or HM-229. Up to two OPC-1541 can be connected. Usable length is 18 meters (60 feet) maximum.

- **HM-205RB** SPEAKER MICROPHONE

Equipped with [▲]/[▼] (channel up/down), [H/L], [16/C], and [PTT] keys, a speaker and microphone.

### ◇ Others

- **SP-37** HORN SPEAKER

The external horn speaker. Connect using the supplied 6 pin accessory connector that supplied with the transceiver.

- **MA-500TR** CLASS B AIS TRANSPONDER

To transmit individual DSC calls to a selected AIS targets.

- **MB-132/MB-75** FLUSH MOUNT KIT

To mount the transceiver to a panel.

- **UX-241** GNSS ANTENNA\*

To receive GPS signals.

\*The same GPS antenna as the antenna supplied with the transceiver.

- **UT-112** VOICE SCRAMBLER UNIT

Ensures private communications. 32 codes are selectable. Not available in some countries.

Ask your service center or technical dealer for installation details.

- **UX-251** AIS RECEIVER UNIT

The optional AIS unit for the version without AIS function. Ask your service center or technical dealer for installation details.

# 14 TROUBLESHOOTING

PROBLEM	POSSIBLE CAUSE	SOLUTION	REF.
The transceiver does not turn ON.	<ul style="list-style-type: none"> <li>• Bad connection to the power supply.</li> <li>• Blown fuse.</li> </ul>	<ul style="list-style-type: none"> <li>• Check the connection to the transceiver and power supply.</li> <li>• Repair the problem, and then replace the fuse.</li> </ul>	<p>p. 94</p> <p>p. 96</p>
Little or no sound comes from the speaker.	<ul style="list-style-type: none"> <li>• Squelch level is set too high.</li> <li>• Volume level is set too low.</li> <li>• The internal speaker is OFF.</li> </ul>	<ul style="list-style-type: none"> <li>• Set the squelch to the threshold point.</li> <li>• Set the volume to a suitable level.</li> <li>• Turn ON the internal speaker.</li> </ul>	<p>p. 18</p> <p>p. 18</p> <p>p. 87</p>
You cannot transmit, or cannot select high power.	<ul style="list-style-type: none"> <li>• Some channels are set for low power or receive only by regulations.</li> <li>• The output power is set to low.</li> </ul>	<ul style="list-style-type: none"> <li>• Change channels.</li> <li>• Push [HI/LO] to select high power.</li> </ul>	<p>pp.14,108</p> <p>p. 18</p>
Scan does not start.	<ul style="list-style-type: none"> <li>• More than 2 favorite channels are not set.</li> </ul>	<ul style="list-style-type: none"> <li>• Set the Favorite channels.</li> </ul>	<p>pp.23,90</p>
No beep sounds.	<ul style="list-style-type: none"> <li>• The Key Beep function is OFF.</li> </ul>	<ul style="list-style-type: none"> <li>• Turn ON the Key Beep function.</li> </ul>	<p>p. 85</p>
The Main screen is not displayed at power ON.	<ul style="list-style-type: none"> <li>• MMSI (DSC self ID) code is not set.</li> </ul>	<ul style="list-style-type: none"> <li>• Set the MMSI (DSC self ID) code.</li> </ul>	<p>p. 9</p>
Individual or Group ID cannot be set.	<ul style="list-style-type: none"> <li>• The entered ID code is incorrect. First digit must be set to between '1' and '9' for an Individual ID. First digit must be set to '0' for a Group ID.</li> </ul>	<ul style="list-style-type: none"> <li>• Enter a correct ID code.</li> </ul>	<p>pp.25,26</p>
"??" blinks instead of the position and time.	<ul style="list-style-type: none"> <li>• 4 hours have passed since you manually entered the position.</li> <li>• The GPS position is invalid.</li> </ul>	<ul style="list-style-type: none"> <li>• Enter the position.</li> </ul>	<p>p. 27</p>
"NO POSITION" and "NO TIME" are displayed instead of the position and time.	<ul style="list-style-type: none"> <li>• The GPS antenna is not correctly connected.</li> <li>• The position and time have not been manually entered.</li> </ul>	<ul style="list-style-type: none"> <li>• Check the GPS antenna connection.</li> <li>• Enter the position and time.</li> </ul>	<p>p. 94</p> <p>p. 27</p>

PROBLEM	POSSIBLE CAUSE	SOLUTION	REF.
Sensitivity is too low, and only strong signals can be heard.	<ul style="list-style-type: none"> <li>The antenna is defective or the coaxial cable connector is shorted or cut.</li> </ul>	<ul style="list-style-type: none"> <li>Repair the problem and then reconnect to the antenna connector.</li> </ul>	p. 94
Communication cannot be established.	<ul style="list-style-type: none"> <li>The antenna is defective or the coaxial cable connector is shorted or cut.</li> </ul>	<ul style="list-style-type: none"> <li>Repair the problem and then reconnect to the antenna connector.</li> </ul>	p. 94
The transceiver is locked up, and does not respond.	<ul style="list-style-type: none"> <li>A software error has occurred.</li> </ul>	<ul style="list-style-type: none"> <li>Turn OFF the transceiver, and then turn it ON again.</li> </ul>	—
The transceiver does not work.	<ul style="list-style-type: none"> <li>The transceiver's Phase Lock Loop is unlocked.</li> </ul>	<ul style="list-style-type: none"> <li>Contact your dealer.</li> </ul>	—

# 15 CHANNEL LIST

## ◇ For IC-M605

Channel Number		Frequency (MHz)		
USA	INT	CAN	Transmit	Receive
	01	01	156.050	160.650
1001	1001*6		156.050	156.050
	02	02	156.100	160.700
	03	03	156.150	160.750
1003*5			156.150	156.150
	04		156.200	160.800
		1004	156.200	156.200
	05		156.250	160.850
1005	1005*6	1005	156.250	156.250
06	06	06	156.300	156.300
	07		156.350	160.950
1007	1007*6	1007	156.350	156.350
08	08	08	156.400	156.400
09	09	09	156.450	156.450
10	10	10	156.500	156.500
11	11	11	156.550	156.550
12	12	12	156.600	156.600
13*1	13	13*2	156.650	156.650
14	14	14	156.700	156.700
15*4	15*3	15*2	156.750	156.750
16	16	16	156.800	156.800
17*2	17	17*2	156.850	156.850
	18		156.900	161.500
1018	1018*6	1018	156.900	156.900
	19		156.950	161.550
1019	1019	1019	156.950	156.950
	2019		161.550*7	161.550
20	20	20*2	157.000	161.600
1020	1020		157.000	157.000

Channel Number		Frequency (MHz)		
USA	INT	CAN	Transmit	Receive
	2020		161.600*7	161.600
	21	21*5	157.050	161.650
1021	1021*6	1021	157.050	157.050
		2021	RX only	161.650
	22		157.100	161.700
1022	1022*6	1022	157.100	157.100
	23	23	157.150	161.750
1023	1023*6		157.150	157.150
		2023*6	RX only	161.750
24	24*5	24	157.200	161.800
25	25*5	25	157.250	161.850
		2025	RX only	161.850
26	26*5	26	157.300	161.900
27	27	27	157.350	161.950
	1027*6		157.350	157.350
28	28	28	157.400	162.000
	1028*6		157.400	157.400
		2028	RX only	162.000
	60	60	156.025	160.625
	61		156.075	160.675
1061*5	1061		156.075	156.075
	62		156.125	160.725
		1062	156.125	156.125
	63		156.175	160.775
1063	1063*6	1063*6	156.175	156.175
	64	64	156.225	160.825
1064*5		1064	156.225	156.225
	65		156.275	160.875
1065	1065*6	1065*3	156.275	156.275

Channel Number		Frequency (MHz)		
USA	INT	CAN	Transmit	Receive
	66		156.325	160.925
1066	1066*6	1066*2	156.325	156.325
67*1	67	67	156.375	156.375
68	68	68	156.425	156.425
69	69	69	156.475	156.475
71	71	71	156.575	156.575
72	72	72	156.625	156.625
73	73	73	156.675	156.675
74	74	74	156.725	156.725
75*5	75*2	75*2	156.775	156.775
76*5	76*2	76*2	156.825	156.825
77*2	77	77*2	156.875	156.875
	78		156.925	161.525
1078	1078	1078	156.925	156.925
	2078		161.525*7	161.525
	79		156.975	161.575
1079	1079	1079	156.975	156.975
	2079		161.575*7	161.575
	80		157.025	161.625
1080	1080*6	1080	157.025	157.025
	81		157.075	161.675
1081	1081*6	1081	157.075	157.075
	82		157.125	161.725
1082	1082*6	1082	157.125	157.125
	83	83*5	157.175	161.775
1083	1083*6	1083	157.175	157.175
		2083	RX only	161.775
	84	84*5	157.225	161.825
1084*5			157.225	157.225

Channel Number		Frequency (MHz)		
USA	INT	CAN	Transmit	Receive
85	85*5	85	157.275	161.875
1085*5			157.275	157.275
86	86*5	86	157.325	161.925
1086*5			157.325	157.325
87	87	87	157.375	157.375
1087*5			157.375	157.375
88	88	88	157.425	157.425
1088*5			157.425	157.425

WX channel*6	Frequency (MHz)	
	Transmit	Receive
1	RX only	162.550
2	RX only	162.400
3	RX only	162.475
4	RX only	162.425
5	RX only	162.450
6	RX only	162.500
7	RX only	162.525
8	RX only	161.650
9	RX only	161.775
10	RX only	163.275

**NOTE:** Simplex channels, 1021, 1023, 1081, 1082 and 1083 **CANNOT** be lawfully used by the general public in USA waters.

\*1 Momentary high power. \*2 Low power only. \*3 Low power only for the USA version. \*4 RX only for the USA version, and Momentary high power for the CHN version.

\*5 For only the CHN version. \*6 For only the USA version. \*7 RX only for the USA version.

◇ For IC-M605EURO

• International channels

CH	Frequency (MHz)		CH	Frequency (MHz)		CH	Frequency (MHz)		CH	Frequency (MHz)		CH	Frequency (MHz)		CH	Frequency (MHz)				
	Transmit	Receive		Transmit	Receive		Transmit	Receive		Transmit	Receive		Transmit	Receive		Transmit	Receive			
01	156.050	160.650	11	156.550	156.550	2019	RX Only	161.550	27	157.350	161.950	66	156.325	160.925	77	156.875	156.875	83	157.175	161.775
02	156.100	160.700	12	156.600	156.600	20	157.000	161.600	28	157.400	162.000	67	156.375	156.375	78	156.925	161.525	84	157.225	161.825
03	156.150	160.750	13	156.650	156.650	1020	157.000	157.000	31 <sup>*1,3</sup>	157.550	162.150	68	156.425	156.425	1078	156.925	156.925	85	157.275	161.875
04	156.200	160.800	14	156.700	156.700	2020	RX Only	161.600	1037 <sup>*2</sup>	157.850	157.850	69	156.475	156.475	2078	RX Only	161.525	86	157.325	161.925
05	156.250	160.850	15 <sup>*1</sup>	156.750	156.750	21	157.050	161.650	60	156.025	160.625	71	156.575	156.575	79	156.975	161.575	87	157.375	157.375
06	156.300	156.300	16	156.800	156.800	22	157.100	161.700	61	156.075	160.675	72	156.625	156.625	1079	156.975	156.975	88	157.425	157.425
07	156.350	160.950	17 <sup>*1</sup>	156.850	156.850	23	157.150	161.750	62	156.125	160.725	73	156.675	156.675	2079	RX Only	161.575	P4 <sup>*4</sup>	161.425	161.425
08	156.400	156.400	18	156.900	161.500	24	157.200	161.800	63	156.175	160.775	74	156.725	156.725	80	157.025	161.625			
09	156.450	156.450	19	156.950	161.550	25	157.250	161.850	64	156.225	160.825	75 <sup>*1</sup>	156.775	156.775	81	157.075	161.675			
10	156.500	156.500	1019	156.950	156.950	26	157.300	161.900	65	156.275	160.875	76 <sup>*1</sup>	156.825	156.825	82	157.125	161.725			

\*1 Low power only.

\*2 For only the HOL and UK version (UK Marina Channel: M1=1037 (157.850 MHz) for UK version), and Low power only for the HOL version.

\*3 For only the HOL version.

\*4 UK Marina Channel: M2=P4 (161.425 MHz) for only the UK version.

# 15 CHANNEL LIST

## • USA channels (For only the UK version.)

CH	Frequency (MHz)		CH	Frequency (MHz)		CH	Frequency (MHz)		CH	Frequency (MHz)		CH	Frequency (MHz)	
	Transmit	Receive		Transmit	Receive		Transmit	Receive		Transmit	Receive		Transmit	Receive
1001	156.050	156.050	15	RX Only	156.750	25	157.250	161.850	71	156.575	156.575	84	157.225	161.825
1005	156.250	156.250	16	156.800	156.800	26	157.300	161.900	72	156.625	156.625	85	157.275	161.875
06	156.300	156.300	17* <sup>1</sup>	156.850	156.850	27	157.350	161.950	73	156.675	156.675	86	157.325	161.925
1007	156.350	156.350	1018	156.900	156.900	28	157.400	162.000	74	156.725	156.725	87	157.375	157.375
08	156.400	156.400	1019	156.950	156.950	1037	157.850	157.850	77* <sup>1</sup>	156.875	156.875	88	157.425	157.425
09	156.450	156.450	20	157.000	161.600	1063	156.175	156.175	1078	156.925	156.925	P4	161.425	161.425
10	156.500	156.500	1020	157.000	157.000	1065	156.275	156.275	1079	156.975	156.975			
11	156.550	156.550	1021	157.050	157.050	1066	156.325	156.325	1080	157.025	157.025			
12	156.600	156.600	1022	157.100	157.100	67* <sup>2</sup>	156.375	156.375	1081	157.075	157.075			
13* <sup>2</sup>	156.650	156.650	1023	157.150	157.150	68	156.425	156.425	1082	157.125	157.125			
14	156.700	156.700	24	157.200	161.800	69	156.475	156.475	1083	157.175	157.175			

\*<sup>1</sup> Low power only.

\*<sup>2</sup> Momentary high power.

**NOTE:** Simplex channels, 1021, 1023, 1081, 1082 and 1083 **CANNOT** be lawfully used by the general public in USA waters.



## ■ About CE and DOC

**C E** Hereby, Icom Inc. declares that the versions of IC-M605EURO which have the “CE” symbol on the product, comply with the essential requirements of the Radio Equipment Directive, 2014/53/EU, and the restriction of the use of certain hazardous substances in electrical and electronic equipment Directive, 2011/65/EU. The full text of the EU declaration of conformity is available at the following internet address:

<https://www.icomjapan.com/support/>

## ■ Disposal



The crossed-out wheeled-bin symbol on your product, literature, or packaging reminds you that in the European Union, all electrical and electronic products, batteries, and accumulators (rechargeable batteries) must be taken to designated collection locations at the end of their working life. Do not dispose of these products as unsorted municipal waste. Dispose of them according to the laws in your area.

# INDEX

<b>A</b>		Configuration		DSC Settings	60
Accessories		Inactivity Timer	86	Alarm Status	62
Accessory connectors set up	97	Internal Speaker	87	Automatic Acknowledgement	60
Speaker Microphone	6	Key Assignment	85	Channel 70 Squelch level	63
Supplied Accessories	97	Key Beep	85	Channel Auto Switch	61
AIS receiver		Noise Cancel	87	DSC data output	62
AIS Classes	73	Power Switch from sub unit	88	DSC procedure	64
Detail screen	76	Speaker	87	Group ID	60
Function display	74	UTC Offset	86	Individual ID	60
Alarm Status	62	Connections	94	Position Input	60
Antenna	96			Self check test	64
<b>B</b>				Group ID deleting	26
Backlight function	19	Dimensions	104	Group ID entering	26
Basic operation	14	Disposal	111	Individual acknowledgement	39
<b>C</b>		DSC operation	25	ACK (Able)	52
Call log		Address ID	25	ACK (New CH)	53
Received Call log	58	Distress call	31	ACK (Unable)	53
Transmitted Call log	59	Regular call	32	Individual ID deleting	26
Channel		Relay acknowledgement	36	Individual ID entering	25
Call channel selecting	14	Resending	34	Position and time entry	27
Call channel setting	17	Sending	31	Receiving	47
Channel 16 selecting	14	Simple call	31	All Ships call	54
Channel area	7			Distress acknowledgement	48
Channel list	108			Distress Call	47
Channel name entry	20			Distress Cancel call	48
Cleaning	96			Distress Relay acknowledgement	50
				Distress Relay call	49
				Group call	55
				Individual acknowledgement	52
				Individual call	51
				Polling Reply call	57
				Polling Request call	56
				Position Reply call	57

Position Request Call .....	56		
Test acknowledgement .....	57		
Test call .....	56		
<b>Sending</b>			
Distress call .....	31		
Distress Cancel call .....	35		
Distress Relay acknowledgement.....	36		
Non-Distress call.....	37		
All Ships call .....	40		
Group call .....	41		
Individual acknowledgement.....	39		
Individual call .....	37		
Polling Request call .....	42		
Position Request acknowledgement..	43		
Position Request call .....	42		
Test call .....	44		
Test call acknowledgement.....	46		
<b>Task mode</b>			
Multiple .....	30		
Single.....	29		
Dualwatch.....	24		
		<b>E</b>	
Emergency .....	ii		
Explicit definitions .....	i		
		<b>F</b>	
Favorite channels .....	23		
Front panel .....	2		
Function display.....	6		
Fuse replacement.....	96		
		<b>G</b>	
Group ID deleting .....	26		
Group ID entering.....	26		
		<b>H</b>	
Hailer .....	68		
Horn .....	69		
		<b>I</b>	
Icon description .....	viii		
InactivityTimer			
Distress Related .....	87		
DSC Related.....	86		
Not DSC Related .....	86		
RT Related.....	87		
Individual ID deleting .....	26		
Individual ID entering.....	25		
Intercom.....	67		
		<b>L</b>	
License			
Operator.....	1		
Ship station .....	1		
		<b>M</b>	
Maintenance			
Antenna .....	96		
Cleaning.....	96		
Fuse replacement.....	96		
Menu items .....	84		
AIS settings.....	80		
CPA/TCPA.....	81		
ID blocking.....	82		
North up/COG UP .....	80		
Compose Distress .....	84		
Compose Non-Distress.....	84		
Configuration .....	84, 85		
Inactivity Timer.....	86		
Key Assignment .....	85		
Key Beep .....	85		
Noise Cancel .....	87		
Power Switch from sub unit .....	88		
Speaker .....	87		
UTC Offset .....	86		
Construction.....	11		
DSC Log .....	84		
DSC Settings .....	84		
NMEA settings .....	91		
NMEA 0183.....	91		
NMEA 2000.....	91		
Radio Settings .....	84		
Call Channel .....	89		
Channel Display.....	90		
Dual/Tri-Watch .....	89		
FAV on MIC.....	90		
FAV Settings .....	90		
Scan Timer.....	88		
Scan Type .....	88		
Microphone Lock function.....	17		
MMSI code entry .....	9		
Mounting the transceiver .....	98		

---

## INDEX

<b>N</b>	
NMEA 0183 .....	91
NMEA 2000 .....	91
Compatible PGN list .....	92
Normal scan .....	22
<b>O</b>	
Operating rules .....	1
Options .....	104
Other messages .....	58
<b>P</b>	
Panel description .....	2
Position and time entry .....	27
Precautions .....	vi
Priority scan .....	22
<b>R</b>	
Radio Settings .....	88
Received Call log .....	58
Receiving .....	18
RX Hailer .....	68
<b>S</b>	
Scan	
Normal scan .....	22
Priority scan .....	22
Software key .....	5
Software key functions in the RCVD CALL LOG screen .....	58
Software key functions in the TX CALL LOG screen .....	59
Speaker Microphone .....	6
Specifications .....	102

<b>T</b>	
Time entry .....	27
Time-out Timer (TOT) function .....	18
Transmitted Call log .....	59
Transmitting .....	18
Tri-watch .....	24
Troubleshooting .....	106
<b>V</b>	
Voice Recorder .....	72
Voice Scrambler .....	71

---

---

---

---

---

---

---

---

---

---

---

---

---

---

---

---

---

---

---

---

---

---

---

---

---

---

---

---

---

---

---

---

---

---

---

---

---

---

---

---

---

---

---

---

---

---

---

**Count on us!**

A7343D-1EX-5a  
Printed in Japan  
© 2017–2021 Icom Inc.    May. 2021

**Icom Inc.**  
1-1-32 Kamiminami, Hirano-ku, Osaka 547-0003, Japan