



INSTRUCTION MANUAL

VHF MARINE TRANSCEIVER

IC-M506

This device complies with Part 15 of the FCC Rules. Operation is subject to the condition that this device does not cause harmful interference.



Icom Inc.

FOREWORD

Thank you for purchasing this Icom product. The IC-M506 VHF MARINE TRANSCEIVER is designed and built with Icom's state of the art technology and craftsmanship. With proper care, this product should provide you with years of trouble-free operation.

We appreciate you making the IC-M506 your radio of choice, and hope you agree with Icom's philosophy of "technology first." Many hours of research and development went into the design of your IC-M506.

◇ **FEATURES**

- *Integrated AIS Receiver* *
- *NMEA 2000™ Connectivity* *
- *2 minutes Last Call Voice Recording*
- *Superb Active Noise Cancelling*

*Depends on transceiver version.

CLEAN THE TRANSCEIVER AND MICROPHONE THOROUGHLY WITH FRESH WATER after exposure to water including salt, otherwise, the keys and switch may become inoperable due to salt crystallization.

IMPORTANT

READ ALL INSTRUCTIONS carefully and completely before using the transceiver.

SAVE THIS INSTRUCTION MANUAL — This instruction manual contains important operating instructions for the IC-M506.

EXPLICIT DEFINITIONS

WORD	DEFINITION
⚠ WARNING!	Personal injury, fire hazard or electric shock may occur.
CAUTION	Equipment damage may occur.
NOTE	If disregarded, inconvenience only. No risk of personal injury, fire or electric shock.

For Canada:

This device complies with RSS-310 of Industry Canada. Operation is subject to the condition that this device does not cause harmful interference.

Cet appareil est conforme au CNR-310 d'Industrie Canada. Son exploitation est autorisée sous réserve que l'appareil ne cause pas de brouillage préjudiciable.

IN CASE OF EMERGENCY

If your vessel requires assistance, contact other vessels and the Coast Guard by sending a Distress call on Channel 16.

USING CHANNEL 16

DISTRESS CALL PROCEDURE

1. "MAYDAY MAYDAY MAYDAY."
2. "THIS IS" (name of vessel).
3. Say your call sign or other description of the vessel (AND 9 digit DSC ID if you have one).
4. "LOCATED AT" (your position).
5. State the nature of the distress and assistance required.
6. Give any other information which might facilitate the rescue.

Or, transmit your Distress call using digital selective calling on Channel 70.

USING DIGITAL SELECTIVE CALLING (Ch 70)

DISTRESS CALL PROCEDURE

1. While lifting up the key cover, hold down [DISTRESS] for 3 seconds until you hear 3 short beeps and then one long beep.
2. Wait for an acknowledgment on Channel 70 from a coast station.
 - After the acknowledgement is received, Channel 16 is automatically selected.
3. Hold down [PTT], then transmit the appropriate information as listed to the left.

RADIO OPERATOR WARNING



Icom requires the radio operator to meet the FCC Requirements for Radio Frequency Exposure. An omnidirectional antenna with gain not greater than 9 dBi must be mounted a minimum of 5 meters (measured from the lowest point of the antenna) vertically above the main deck and all possible personnel. This is the minimum safe separation distance estimated to meet all RF exposure compliance requirements. This 5 meter distance is based on the FCC Safe Maximum Permissible Exposure (MPE) distance of 3 meters added to the height of an adult (2 meters) and is appropriate for all vessels.

For watercraft without suitable structures, the antenna must be mounted so as to maintain a minimum of 1 meter vertically between the antenna, (measured from the lowest point of the antenna), to the heads of all persons AND all persons must stay outside of the 3 meter MPE radius.

Do not transmit with radio and antenna when persons are within the MPE radius of the antenna, unless such persons (such as driver or radio operator) are shielded from antenna field by a grounded metallic barrier. The MPE Radius is the minimum distance from the antenna axis that person should maintain in order to avoid RF exposure higher than the allowable MPE level set by FCC.

FAILURE TO OBSERVE THESE LIMITS MAY ALLOW THOSE WITHIN THE MPE RADIUS TO EXPERIENCE RF RADIATION ABSORPTION WHICH EXCEEDS THE FCC MAXIMUM PERMISSIBLE EXPOSURE (MPE) LIMIT. IT IS THE RESPONSIBILITY OF THE RADIO OPERATOR TO ENSURE THAT THE MAXIMUM PERMISSIBLE EXPOSURE LIMITS ARE OBSERVED AT ALL TIMES DURING RADIO TRANSMISSION. THE RADIO OPERATOR IS TO ENSURE THAT NO BYSTANDERS COME WITHIN THE RADIUS OF THE MAXIMUM PERMISSIBLE EXPOSURE LIMITS.

Determining MPE Radius

THE MAXIMUM PERMISSIBLE EXPOSURE (MPE) RADIUS HAS BEEN ESTIMATED TO BE A RADIUS OF ABOUT 3M PER OET BULLETIN 65 OF THE FCC. THIS ESTIMATE IS MADE ASSUMING THE MAXIMUM POWER OF THE RADIO AND ANTENNAS WITH A MAXIMUM GAIN OF 9dBi ARE USED FOR A SHIP MOUNTED SYSTEM.

AVERTISSEMENT POUR LES OPÉRATEURS RADIO



AVERTISSEMENT

Icom exige que l'opérateur radio se conforme aux exigences de la FCC en matière d'exposition aux radiofréquences. Une antenne omnidirectionnelle dont le gain ne dépasse pas 9dBi doit être fixée à une distance minimale de 5 mètres (mesurée depuis le point le plus bas de l'antenne) verticalement au-dessus du pont principal et de tout le personnel qui peut s'y trouver. Il s'agit de la distance de sécurité minimale prévue pour satisfaire aux exigences de conformité en matière d'exposition aux RF. Cette distance de 5 mètres est établie en fonction de l'exposition maximale admissible sécuritaire de 3 mètres établie par la FCC, à laquelle on ajoute la hauteur d'un adulte (2 mètres); cette distance convient pour tous les navires.

Dans le cas des embarcations sans structure convenable, l'antenne doit être fixée de façon à maintenir une distance minimale de 1 mètre verticalement entre cette antenne (mesurée depuis son point le plus bas) et la tête de toute personne présente; toutes les personnes présentes doivent se tenir à l'extérieur d'un rayon d'exposition maximale admissible de 3 mètres.

Ne pas émettre à l'aide de la radio et de l'antenne lorsque des personnes se trouvent à l'intérieur du rayon d'exposition maximale admissible de cette antenne, à moins que ces personnes (comme le conducteur ou l'opérateur radio) ne soient protégées du champ de l'antenne par un écran métallique relié à la masse. Le rayon d'exposition maximale admissible équivaut à la distance minimale que cette personne doit maintenir entre elle et l'axe de l'antenne pour éviter une exposition aux RF supérieure au niveau d'exposition maximale admissible fixé par la FCC.

LE NON-RESPECT DE CES LIMITES PEUT CAUSER, POUR LES PERSONNES SITUÉES DANS LE RAYON D'EXPOSITION MAXIMALE ADMISSIBLE, UNE ABSORPTION DE RAYONNEMENT DE RF SUPÉRIEURE À L'EXPOSITION MAXIMALE ADMISSIBLE FIXÉE PAR LA FCC.

L'OPÉRATEUR RADIO EST RESPONSABLE D'ASSURER QUE LES LIMITES D'EXPOSITION MAXIMALE ADMISSIBLE SOIENT RESPECTÉES EN TOUT TEMPS PENDANT LA TRANSMISSION RADIO. L'OPÉRATEUR RADIO DOIT S'ASSURER QU'AUCUNE PERSONNE PRÉSENTE NE SE SITUE À L'INTÉRIEUR DU RAYON D'EXPOSITION MAXIMALE ADMISSIBLE.

Établir le rayon d'exposition maximale admissible

ON ESTIME QUE LE RAYON D'EXPOSITION MAXIMALE ADMISSIBLE EST D'ENVIRON 3 M, TEL QUE STIPULÉ DANS LE BULLETIN OET 65 DE LA FCC. CETTE DISTANCE ESTIMÉE TIEN COMPTE D'UN SYSTÈME INSTALLÉ SUR UN NAVIRE UTILISANT LA PUISSANCE MAXIMALE DE LA RADIO ET DES ANTENNES DONT LE GAIN MAXIMAL EST DE 9dBi.

FCC INFORMATION

• **FOR CLASS A UNINTENTIONAL RADIATORS:**

This equipment has been tested and found to comply with the limits for a Class A digital device, pursuant to part 15 of the FCC Rules. These limits are designed to provide reasonable protection against harmful interference when the equipment is operated in a commercial environment. This equipment generates, uses, and can radiate radio frequency energy and, if not installed and used in accordance with the instruction manual, may cause harmful interference to radio communications.

Operation of this equipment in a residential area is likely to cause harmful interference in which case the user will be required to correct the interference at his own expense.

NOTE

A WARNING STICKER is supplied with the U.S.A. version transceiver.

To comply with FCC regulations, this sticker must be affixed in such a location as to be readily seen from the operating controls of the radio as in the diagram below. Make sure the chosen location is clean and dry before applying the sticker.

EXAMPLE



PRECAUTIONS

⚠ WARNING! NEVER connect the transceiver to an AC outlet. This may pose a fire hazard or result in an electric shock.

⚠ WARNING! NEVER connect the transceiver to a power source of more than 16 V DC or use reverse polarity. This will ruin the transceiver.

⚠ WARNING! NEVER cut the DC power cable between the DC plug at the back of the transceiver and fuse holder. If an incorrect connection is made after cutting, the transceiver may be damaged.

CAUTION: NEVER place the transceiver where normal operation of the vessel may be hindered or where it could cause bodily injury.

KEEP the transceiver and microphone at least 1 m away from the vessel's magnetic navigation compass.

DO NOT use or place the transceiver in areas with temperatures below -20°C (-4°F) or above $+60^{\circ}\text{C}$ ($+140^{\circ}\text{F}$) or, in areas subject to direct sunlight, such as the dashboard.

DO NOT use harsh solvents such as benzine or alcohol to clean the transceiver, as they will damage the transceiver's surfaces. If the transceiver becomes dusty or dirty, wipe it clean with a soft, dry cloth.

DO NOT disassemble or modify the transceiver for any reason.

BE CAREFUL! The transceiver rear panel will become hot when operating continuously for long periods of time.

Place the transceiver in a secure place to avoid inadvertent use by children.

BE CAREFUL! The transceiver meet IPX8 requirements and the optional HM-195 COMMANDMICIV™ meet IPX7 requirements for waterproof protection. However, once the transceiver has been dropped, waterproof protection cannot be guaranteed because of possible damage to the transceiver's case or the waterproof seal.

* Except for the DC power connector, NMEA In/Out leads and AF Out leads.

For U.S.A. only

CAUTION: Changes or modifications to this device, not expressly approved by Icom Inc., could void your authority to operate this device under FCC regulations.

Icom, Icom Inc. and Icom logo are registered trademarks of Icom Incorporated (Japan) in Japan, the United States, the United Kingdom, Germany, France, Spain, Russia, Australia, New Zealand, and/or other countries.

COMMANDMIC is a registered trademark of Icom Incorporated (Japan) in Japan and the United States.

TABLE OF CONTENTS

FOREWORD	i	5 SCAN OPERATION.....	16–17
IMPORTANT	i	■ Scan types	16
EXPLICIT DEFINITIONS.....	i	■ Setting Favorite channels.....	17
IN CASE OF EMERGENCY	ii	■ Starting a scan.....	17
RADIO OPERATOR WARNING	iii	6 DUALWATCH/TRI-WATCH.....	18
AVERTISSEMENT POUR LES OPÉRATEURS RADIO.....	iv	■ Description	18
FCC INFORMATION	v	■ Operation	18
NOTE.....	v	7 DSC OPERATION	19–74
PRECAUTIONS.....	vi	■ DSC address ID	19
1 OPERATING RULES.....	1	■ Position and time programming.....	22
2 PANEL DESCRIPTION.....	2–7	■ Distress call.....	23
■ Front panel	2	■ Transmitting DSC calls.....	30
■ Function display	5	■ Receiving DSC calls	55
■ Speaker Microphone	7	■ Received Call log	67
■ Softkey function.....	7	■ Transmitted Call log.....	69
3 PREPARATION.....	8	■ DSC Settings	70
■ MMSI code programming.....	8	■ Making an Individual call using an AIS transponder ..	74
4 BASIC OPERATION.....	9–15	8 OTHER FUNCTIONS.....	76–80
■ Channel selection	9	■ Intercom operation	76
■ Receiving and transmitting.....	11	■ RX Hailer function	77
■ Call channel programming	13	■ Hailer operation.....	77
■ Channel name programming.....	13	■ Horn function.....	78
■ Microphone Lock function	14	■ Voice scrambler operation	80
■ Adjusting the Backlight level.....	15	■ Voice recorder function	80
■ AquaQuake water draining function	15		

9 AIS RECEIVER (Depending on versions).....	81–88
■ About AIS	81
■ AIS Classes	81
■ Function display	82
■ About the detail screen	85
■ AIS Settings	88
10 NMEA 2000 CONNECTION	
(Depending on versions).....	91–92
■ Description	91
11 MENU SCREEN OPERATION	93–104
■ Menu screen operation	93
■ Menu screen items.....	94
■ Configuration items	95
■ Radio Settings items	100
12 CONNECTIONS AND MAINTENANCE	105–112
■ Connections	105
■ Antenna.....	107
■ Fuse replacement	107
■ Cleaning.....	107
■ Supplied accessories.....	107
■ Mounting the transceiver.....	108
■ MB-75/MB-132 installation.....	109
■ Microphone installation	111

13 SPECIFICATIONS AND OPTIONS	113–114
■ Specifications	113
■ Options.....	114
14 CHANNEL LIST.....	115
15 TEMPLATE.....	116
16 TROUBLESHOOTING.....	118

◇ Priorities

- Read all rules and regulations pertaining to call priorities, and keep an up-to-date copy handy. Safety and distress calls take priority over all others.
- You must monitor Channel 16 when you are not operating on another channel.
- False or fraudulent distress calls are prohibited under law.

◇ Privacy

- Information overheard, but not intended for you, cannot lawfully be used in any way.
- Indecent or profane language is prohibited.

◇ Radio licenses

(1) SHIP STATION LICENSE

You may require a current radio station license before using the transceiver. It is unlawful to operate a ship station which is not licensed, but required to be.

If required, contact your dealer or the appropriate government agency for a Ship-Radiotelephone license application. This government-issued license states the call sign which is your craft's identification for radio purposes.

(2) OPERATOR'S LICENSE

A Restricted Radiotelephone Operator Permit is the license most often held by small vessel radio operators when a radio is not required for safety purposes.

If required, the Restricted Radiotelephone Operator Permit must be posted or kept with the operator. If required, only a licensed radio operator may operate a transceiver.

However, non-licensed individuals may talk over a transceiver if a licensed operator starts, supervises, ends the call and makes the necessary log entries.

A current copy of the applicable government rules and regulations is only required to be on hand for vessels in which a radio telephone is compulsory. However, even if you are not required to have these on hand it is your responsibility to be thoroughly acquainted with all pertinent rules and regulations.

NOTE: Even though the transceiver is capable of operation on VHF marine channels 3, 21, 23, 61, 64, 81, 82 and 83, according to FCC regulations these simplex channels cannot be lawfully used by the general population in USA waters.

■ Front panel

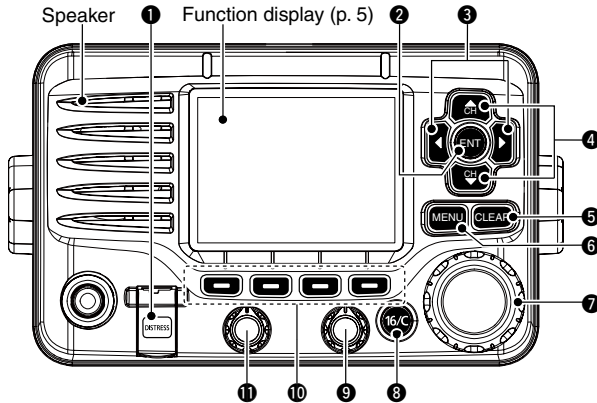

- 1 DISTRESS KEY [DISTRESS]** (pp. 23, 24)
Hold down for 3 seconds to transmit a Distress call.
- 2 ENTER KEY [ENT]**
Push to set the input data, selected item, and so on.
- 3 LEFT AND RIGHT KEYS [◀]/[▶]**
 - Push to switch to the previous or next key function that is assigned to the softkeys. (p. 7)
 - Push to select a desired character or number in the table while in the channel name, position, MMSI code programming mode, and so on. (pp. 8, 13, 22)

- 4 UP AND DOWN/CHANNEL SELECT KEYS [▲CH]/[▼CH]**
 - Push to select the operating channels, Menu items, Menu settings, and so on.
 - While scanning, push to check Favorite channels, change the scanning direction or manually resume a scan. (p. 17)
- 5 CLEAR KEY [CLEAR]**
Push to cancel the entered data, or to return to the previous screen.
- 6 MENU KEY [MENU]**
Push to enter or exit the Menu screen. (p. 93)

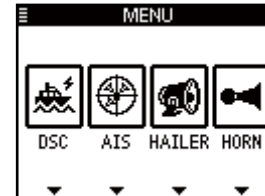

2 PANEL DESCRIPTION

■ Front panel (Continued)

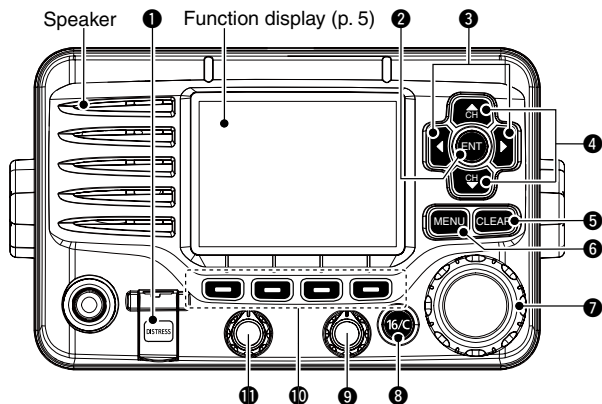

7 DIAL/POWER SWITCH [PWR]

- ➔ When the power is OFF, hold down for 1 second to turn ON power.
- ➔ Hold down for 1 second to turn OFF power.
- ➔ Rotate to select the operating channels, Menu items, Menu settings, and so on.
- ➔ Push to set the input data, selected item, and so on.

8 CHANNEL 16/CALL CHANNEL KEY [16/C]

- ➔ Push to select Channel 16. (p. 9)
- ➔ Hold down for 1 second to select the Call channel. (p. 9)
 - The “CALL” icon appears when the Call channel is selected.

9 SQUELCH DIAL

Rotate to adjust the squelch level.

10 SOFTKEYS

Desired functions as described below can be assigned in the Menu screen. (p. 96)

Distress Call [DTRS]

Push to enter “DISTRESS CALL” in the DSC menu to select the nature of the call, and then to make a call.

DSC [DSC]

Push to enter the DSC menu to compose a DSC call.

Scan [SCAN] (p. 17)

Push to start or stop a Normal or Priority scan.

Dualwatch/Tri-watch [DW] (p. 18)

- ➔ Push to start a Dualwatch or Tri-watch.
- ➔ Push to stop a Dualwatch or Tri-watch when either is activated.

AIS [AIS]* (p. 87)

Push to display the AIS plotter on the left side of the display.

*Some versions of IC-M506 do not have an AIS receiver.

Channel/Weather channel [CH/WX] (pp. 9, 11)

Push to select and toggles the regular channel and Weather channel.

High/Low [HW/LO] (p. 11)

Push to set the power to high or low.

- Some channels are set to only low power.

Voice Scrambler [SCL]* (p. 80)

Push to turn the Voice Scrambler ON or OFF.

- The “SBL” icon appears when the voice scrambler is ON.

*This key appears only when the voice scrambler unit is installed.

Voice Recorder [PLAY] (p. 80)

Push to playback recorded voice.

RX Hailer [RX/H] (p. 77)

Push to turn the RX Hailer mode ON or OFF.

LO/DX [LOW/DX] (p. 11)

Push to turn the Attenuator function ON or OFF.

- The “LOC” icon appears when the Attenuator function is ON.

Favorite channel [FV] (p. 17)

- ➔ Push to set or clear the displayed channel as a Favorite (Tag) channel.
- ➔ Hold down for 3 seconds to clear or set all Favorite channels in the selected channel group.

Name [NAME] (p. 13)

Push to enter the channel name programming mode.

Backlight [BLT] (p. 15)

Push to enter the LCD and key backlight brightness adjustment mode.

Log [LOG] (p. 67)

Push to enter “RCVD CALL LOG” in the DSC CALLS menu.

① VOLUME DIAL

Rotate to adjust the volume level.

2 PANEL DESCRIPTION

■ Function display

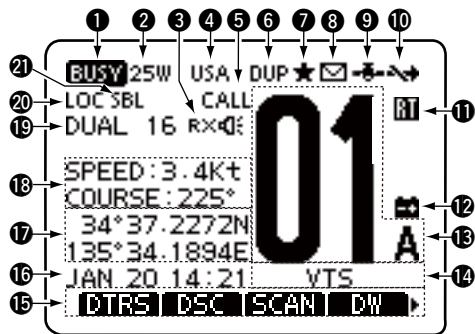

❶ BUSY/TRANSMIT ICON (pp. 11, 12)

- ➔ The “**BUSY**” icon appears when receiving a signal or when the squelch is open.
- ➔ The “**TX**” icon appears while transmitting.

❷ POWER ICON (p. 11)

- ➔ The “25W” icon appears when high power is selected.
- ➔ The “1W” icon appears when low power is selected.

❸ RX HAILER ICON (p. 77)

Appears while in the RX Hailer mode.

❹ CHANNEL GROUP ICON (p. 10)

- ➔ The selected channel group icon, USA “USA,” International “INT” or Canadian “CAN” appears.
- ➔ The “WX” icon appears when the weather channel is selected.

❺ CALL CHANNEL ICON (p. 9)

Appears when the Call channel is selected.

❻ DUPLEX ICON (p. 10)

Appears when a duplex channel is selected.

❼ FAVORITE CHANNEL ICON (p. 17)

Appears when a Favorite (Tag) channel is selected.

❽ MESSAGE ICON

Blinks when there is an unread DSC message.

❾ GPS ICON

- ➔ Stays ON when the GPS receiver is activated and valid position data is received.
- ➔ Blinks when invalid position data is being received.

❿ SWITCH ICON (p. 71)

Appears when the “CH 16 SWITCH” in DSC Settings is set to OFF.

⓫ RT (Radio Telephone) ICON

Displayed while in the Radio Telephone (RT) mode.

- Returns to the Standby mode if no operation occurs during the preset period of time.
- The icon is displayed if the “RT Indicator:” item in the RADIO SET menu is set to “ON.”

⓬ LOW BATTERY ICON

Blinks when the battery voltage drops to approximately 10.8 V DC or less.

⓭ CHANNEL NUMBER READOUT

Shows the selected operating channel number.

- When a simplex channel is selected, “A” or “B” appears.

14 CHANNEL NAME FIELD

The channel name appears, if programmed. (p. 13)

15 KEY ICON (p. 7)

Shows the programmed function of the softkeys on the front panel.

16 TIME ZONE INDICATOR

➤ Shows the current time when a GPS receiver is connected, or the time is manually programmed.

- When the GPS current time is invalid, “??” will blink every 2 seconds instead of the current time. After 23.5 hours has passed, “NO TIME” will appear.

- “??” will blink every 2 seconds instead of the current time, after 3 hours and 59 minutes have passed from when the time was manually programmed. The manually programmed time is held for only 23.5 hours, and after that, “NO TIME” will appear.

➤ “LOCAL” appears when the offset time is set.

➤ “MNL” appears when the time is manually programmed.

➤ “UTC” appears when the GGA, GLL or GNS GPS sentence formats are included in the GPS signal.

➤ The date information appears when the RMC GPS sentence formats are included in the GPS signal.

➤ “NO TIME” appears when no GPS receiver is connected, and no time is manually input.

17 POSITION INDICATOR

➤ Shows the current position when a GPS receiver is connected, or the position is manually programmed.

- When the GPS position is invalid, “??” may blink every 2 seconds instead of position. The last position is held for only 23.5 hours, and after that, “NO POSITION” will appear.

- “??” will blink every 2 seconds instead of position, after 3 hours and 59 minutes have passed from when the position is manually programmed. The manually programmed position is held for only 23.5 hours, and after that, “NO POSITION” will appear.

➤ “NO POSITION” appears when no GPS receiver is connected, and no position is manually input.

18 COURSE/SPEED INDICATOR

Shows the course and speed of your vessel if the GPS receiver is connected to the transceiver.

- Course and speed are displayed when the RMC GPS sentence format is included in the GPS signal.

Course and speed are also displayed when the VTG and either the GGA, GLL or GNS GPS sentence formats are included in the GPS signal.

19 SCAN INDICATOR

➤ “SCAN 16” appears during a Priority scan; “SCAN” appears during a Normal scan. (p. 17)

➤ “DUAL 16” appears during Dualwatch; “TRI 16” appears during Tri-watch. (p. 18)

20 LOCAL ICON (p. 11)

Appears when the Attenuator function is turned ON.

21 VOICE SCRAMBLER ICON* (p. 80)

Appears when the Voice Scrambler function is turned ON.

*Appears only when the voice scrambler unit is installed.

2 PANEL DESCRIPTION

■ Speaker Microphone

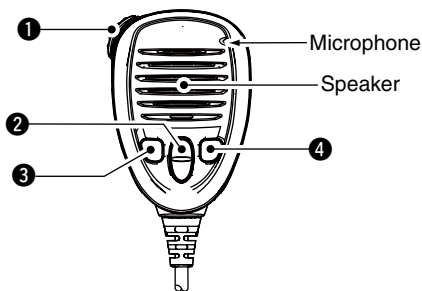

❶ PTT SWITCH [PTT]

Hold down to transmit, release to receive. (pp. 11, 12)

❷ CHANNEL UP/DOWN KEYS [▲]/[▼]

Push either key to check favorite channels, change scanning direction or manually resumes a scan. (pp. 11, 18)

- You can turn OFF the FAV on MIC setting (p. 100). After that, you can select all channels by these keys.

❸ TRANSMIT POWER KEY [H/L]

- ➔ Push to toggle the power high or low. (p. 11)
 - Some channels are set to only low power.
- ➔ While holding down [H/L], turn ON the power to turn the Microphone Lock function ON or OFF. (p. 14)

❹ CHANNEL 16/CALL CHANNEL KEY [16/C]

- ➔ Push to select Channel 16. (p. 9)
- ➔ Hold down for 1 second to select the Call channel. (p. 9)
 - The “CALL” icon appears when the Call channel is selected.

■ Softkey function

Various functions can be assigned to the softkeys. When a key function is assigned, the key icon is displayed above the softkey, as shown below.

◇ Softkey function selection

When “◀” or “▶” is displayed beside the key icon, pushing [◀]/[▶] to scroll key functions that is assigned to the softkey. The key movement is set to “Group” in default. 4 icons move by pushing [◀]/[▶] once. You can set the key movement of your choice in menu screen. (p. 96)

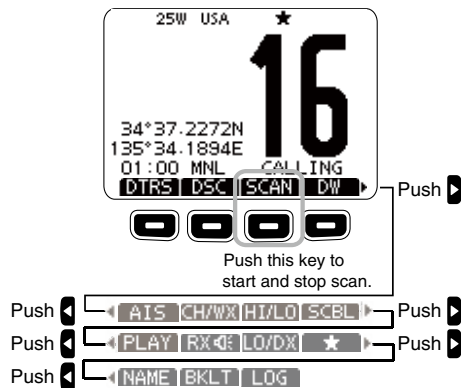

/// The order of the key icons may differ, depending on the transceiver version.

■ MMSI code programming

The 9 digit MMSI (Maritime Mobile Service Identity: DSC self ID) code can be programmed at power ON.

This initial code setting can be performed only once. After being set, it can be changed by only your dealer or distributor. If your MMSI code has already been programmed, this programming is not necessary.

- ① Hold down [PWR](Dial) to turn ON the power.
 - Three short beeps sound, and “NO DSC MMSI” is displayed.
- ② Push [ENT] to start the MMSI code programming.
 - Push [CLEAR] twice to cancel the programming, and go to the normal operating screen. In this case, the transceiver cannot make a DSC call. To program the MMSI code, turn OFF the power, then turn it ON again.
- ③ Enter your MMSI code in the following manner:
 - Select a desired number using [▲]/[▼]/[◀]/[▶].
 - Push [ENT] or dial to set it.
 - To move the cursor, rotate dial or select either arrow, “←” or “→,” then push [ENT] or dial.

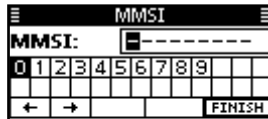

- ④ Repeat step ③ to enter all 9 digits.
- ⑤ After entering the 9 digit code, “FINISH” is automatically selected, and then push [ENT] or dial to set it.
- ⑥ The “MMSI CONFIRMATION” screen is displayed.

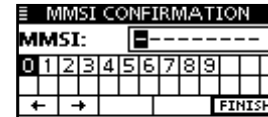

- ⑦ Enter your MMSI code again for confirmation.
 - Enter in the same manner as steps ③ through ⑤.
- ⑧ When your MMSI code programming is successfully completed, the screen as shown below is briefly displayed.
 - After that, the normal operating screen is displayed.



The programmed MMSI code can be checked in the MENU screen. (p. 94)

■ Channel selection

◇ Channel 16

Channel 16 is the distress and safety channel. It is used for establishing initial contact with a station and for emergency communications.

While standing by, you must monitor Channel 16. Channel 16 is automatically monitored during both Dualwatch and Tri-watch.

- Push [16/C] to select Channel 16.
- Push [CH/WX] to return to the screen displayed before you selected Channel 16, or rotate dial or push [▲](CH)/[▼](CH) to select an operating channel.



◇ Call channel

Each regular channel group has a separate leisure use Call channel. The Call channels can be programmed, and are used to store your most often used channel in each channel group, for quick recall.

The Call channel is monitored during Tri-watch. (p. 13)

- Hold down [16/C] for 1 second to select the Call channel of the selected channel group.
 - The “CALL” icon and the Call channel number appear.
 - Each channel group has an independent call channel after programming. (p. 13)
- Push [CH/WX] to return to the screen displayed before you selected Call channel, or rotate dial or push [▲](CH)/[▼](CH) to select an operating channel.

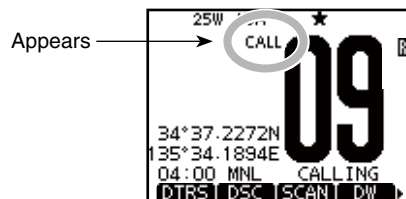

◇ Channel group selection

There are preprogrammed USA channels, International channels and Canadian channels. These channel groups may be specified for the operating area.

- ① Push [MENU].
- ② Rotate dial or push [◀]/[▶] to select the “RADIO SET” icon and then push the softkey below the icon.
 - RADIO SETTINGS menu is displayed.
- ③ Rotate dial or push [▲]/[▼] to select “CHAN Group,” and then push [ENT].



- ④ Rotate dial or push [▲]/[▼] to select the desired channel group, and then push [ENT].
 - USA (USA), International (INT) and Canadian (CAN) channel groups can be selected.
 - Push [BACK] to return to the previous screen.



- ⑤ Push [EXIT] to exit the Menu screen.
- ⑥ Rotate dial or push [▲](CH)/[▼](CH) to select a channel.
 - Pushing [▲]/[▼] on the microphone selects only Favorite channels.
 - You can turn OFF the FAV on MIC setting (p. 104). After that, you can select all channels by the microphone.
 - The “DUP” icon appears when a duplex channel is selected.
 - “A” appears when a simplex channel is selected.

Channel group icon appears

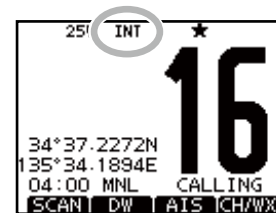

When the International channel group is selected.

4 BASIC OPERATION

◇ Weather channels

The transceiver has 10 weather channels. These are used for monitoring broadcasts from NOAA. (National Oceanographic and Atmospheric Administration)

The transceiver can automatically detect a weather alert tone on the selected weather channel or while scanning. (p. 16)

- ① Push [CH/WX] once or twice to select the weather channel.
 - When a weather channel is selected, the “WX” icon appears.
 - When the Weather Alert function is in turned ON, the “WX ” icon appears. (p. 101)
- ② Rotate dial or push [▲](CH)/[▼](CH) to select a channel.
 - Pushing [▲]/[▼] on the microphone also selects a channel.

When weather alert is OFF.

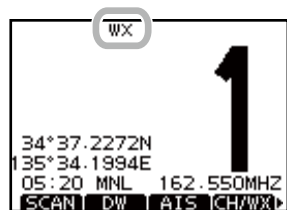

When weather alert is ON.

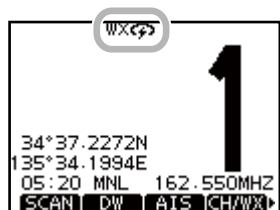

■ Receiving and transmitting

⚡ **CAUTION: DO NOT** transmit without an antenna.

- ① Hold down [PWR](Dial) to turn ON the power.
- ② Set the audio and squelch levels. (pp. 3, 4)
 - ➔ First, open the squelch. Then, adjust the audio output level. After that, adjust the squelch level until the noise just disappears.
- ③ Change the channel group. (p. 10)
- ④ Rotate dial or push [▲](CH)/[▼](CH) to select a channel. (pp. 9, 10)
 - Pushing [▲]/[▼] on the microphone selects only Favorite channels.
 - You can turn OFF the FAV on MIC setting (p. 104). After that, you can select all channels by the microphone.
 - When receiving a signal, the “**BUSY**” icon appears and audio is heard.
 - Further adjustment of the volume level may be necessary.
- ⑤ Push [LO/DX] to turn the receive Attenuator function ON or OFF, if necessary.
 - The “LOC” icon appears when the receive Attenuator function is ON.
- ⑥ Push [HI/LO] to select the output power, if necessary.
 - The “25W” icon appears when high power is selected, and the “1W” icon appears when low power is selected.
 - Choose low power for short range communications, choose high power for longer distance communications.
 - Some channels are for only low power.

- ⑦ Hold down [PTT] to transmit, then speak at your normal voice level.
 - The “**TX**” icon appears.
 - Channel 70 cannot be used for transmission other than DSC.
- ⑧ Release [PTT] to receive.

✓ Information

The Noise Cancel function reduces random noise components in the transmit and/or receive signal. See page 99 for details.

/// Simplex channels, 3, 21, 23, 61, 64, 81, 82 and 83 CANNOT be lawfully used by the general public in U.S.A. waters.

/// **IMPORTANT:** To maximize the readability of your transmitted signal, pause a few seconds after pushing [PTT], hold the microphone 5 to 10 cm (2 to 4 inches) from your mouth and speak at a normal voice level.

✓ NOTE for the TOT (Time-out Timer) function

The TOT function inhibits continuous transmission beyond a preset time period after the transmission starts.

10 seconds before transmission is cutoff, a beep sounds to indicate the transmission will be shut down and “TOT” appears in the channel name field. Transmission is not possible for 10 seconds after this shut down.

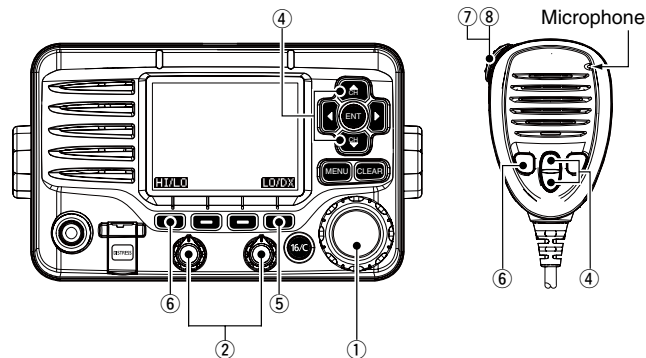

4 BASIC OPERATION

■ Call channel programming

You can program the Call channel with your most often-used channel in each channel group for quick recall.

- ① Select the desired channel group (INT, USA or CAN) to be programmed. (p. 10)
- ② Push [MENU].
- ③ Rotate dial or push [◀]/[▶] to select the “RADIO SET” icon and then push the softkey below the icon.
 - RADIO SETTINGS menu is displayed.
- ④ Rotate dial or push [▲]/[▼] to select “CALL CHAN,” and then push [ENT].
- ⑤ Rotate dial or push [▲](CH)/[▼](CH) to select a channel.

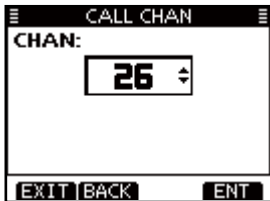

- ⑥ Push [ENT] to save the channel as the Call channel.
 - Push [BACK] to cancel and return to the previous screen.
- ⑦ Push [EXIT] to exit the Menu screen.

■ Channel name programming

Each channel can be assigned a unique alphanumeric ID of up to 10 characters.

Capital letters, 0 to 9, some symbols (! " # \$ % & ' () * + , - . / [\] ^ _ : ; < = > ?) and a space can be input.

- ① Rotate dial or push [▲](CH)/[▼](CH) to select a channel.
 - First, cancel the Dualwatch, Tri-watch or Scan function, if activated.
- ② Push [NAME] to open the channel name programming screen.
 - A cursor is displayed on the first character.
- ③ Enter the desired channel name in the following manner:
 - Select a desired character using [▲]/[▼]/[◀]/[▶].
 - Push [ENT] or dial to set it.
 - To move the cursor, rotate dial or select either arrow, “←” or “→,” then push [ENT] or dial.
 - Push [123], [!\$?] or [ABC] to select a character group.
 - Select “SPACE,” then push [ENT] to input a space.
 - Select “DELETE,” then push [ENT] to delete a character.
 - Push [CLEAR] to cancel and return to the previous screen.



④ Repeat step ③ to input all characters.



⑤ Push [◀]/[▶]/[▲]/[▼] to select “FINISH,” then push [ENT] to set the name and return to the previous screen.

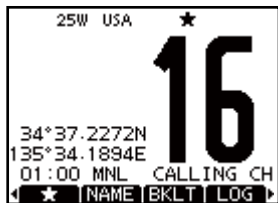

Microphone Lock function

The Microphone Lock function electrically locks [▲], [▼], [16/C] and the [H/L] keys on the supplied microphone. This prevents accidental channel changes and function access.

➤ While holding down [H/L] on the microphone, hold down [PWR](Dial) to turn ON the transceiver and turn the Microphone Lock function ON or OFF.

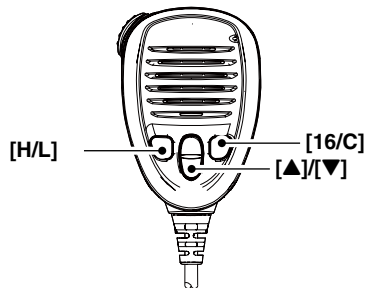

4 BASIC OPERATION

■ Adjusting the Backlight level

The function display and keys can be backlit for better visibility under low light conditions.

The backlight is adjustable in 7 levels and OFF.

Depending on the preprogramming, the adjustment method differs, as described below.

- Push [BKLT] to show the backlight adjustment screen. Rotate dial or push [▲]/[▼]/[◀]/[▶] to adjust the brightness of the LCD and key backlight, and then, push [ENT].
 - If no key operation is performed for about 5 seconds, the transceiver sets the selected backlight level, and returns to the normal mode.

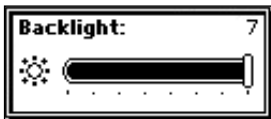

■ AquaQuake water draining function

The AquaQuake water draining function clears water away from the speaker grill. Without this function, water may muffle the sound coming from the speaker. A buzzing sound is heard when this function is activated.

- ① Push [MENU].
- ② Rotate dial or push [◀]/[▶] to select the “AQUA QUAKE,” icon and then push the softkey below the icon.
 - AQUAQUAKE screen is displayed.

- While holding down [AQUA], the AquaQuake function is activated to clear water away from the speaker grill.
 - While holding down [AQUA], a low buzzing sounds to drain water, regardless of the volume level setting.
 - The transceiver keys, except [DISTRESS], are disabled while the AquaQuake function is activated.



When the AquaQuake function is activated.

■ Scan types

Scanning is an efficient way to locate signals quickly over a wide frequency range. The transceiver has a Priority scan and a Normal scan.

When the Weather Alert function is turned ON, the weather channel is also checked while scanning. (p. 101)

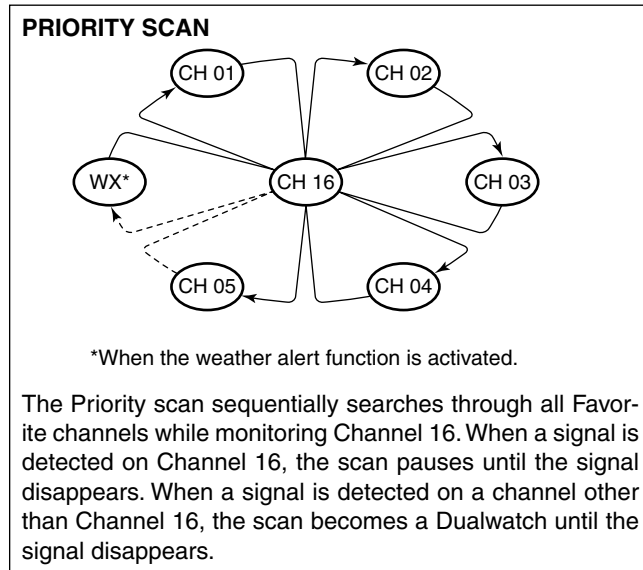

Set the Favorite channels (scanned channel) before scanning. Clear the Favorite channels which inconveniently stop scanning, such as those for digital communication use. (Refer to the next page for details.)

☞ Choose Priority or Normal scan in the Menu screen. (p. 100)

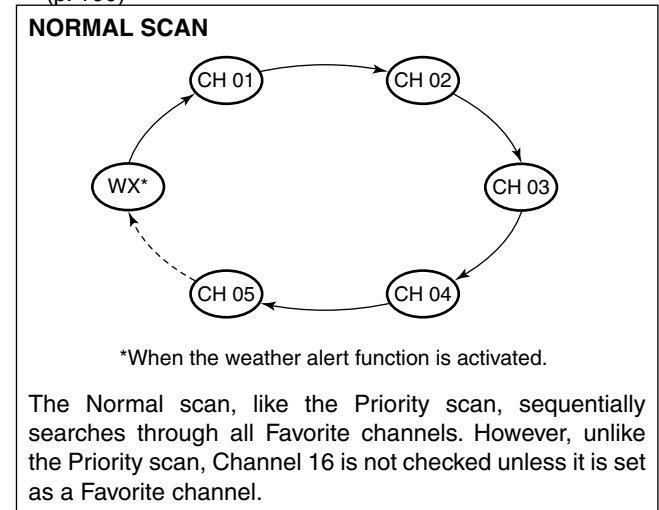

5 SCAN OPERATION

■ Setting Favorite channels

For more efficient scanning, add desired channels as Favorite channels, or clear the Favorite on unwanted channels. Channels that are not tagged will be skipped while scanning. Favorite channels can be independently assigned to each channel group (INT, USA, or CAN).

- ① Select the desired channel group. (p. 10)
- ② Select the desired channel to be set as a Favorite channel.
- ③ Push [★] to set the displayed channel as a Favorite channel.
 - The “★” icon appears on the display.
- ④ To cancel the Favorite channel setting, repeat step ③.
 - The “★” icon disappears.

✓ Clearing (or setting) all Favorite channels

Hold down [★] for 3 seconds (until a long beep changes to 2 short beeps) to clear all Favorite channel settings in the selected channel group.

- Repeat above procedure to set all channels as Favorite channels.

■ Starting a scan

First, set the scan type (Priority or Normal scan) and scan resume timer in the Menu screen. (p. 100)

- ① Select the desired channel group. (p. 10)
- ② Set the Favorite channels, as described to the left.
- ③ Make sure the squelch is closed to start a scan.
- ④ Push [SCAN] to start a Priority or Normal scan.
 - “SCAN 16” appears during a Priority scan; “SCAN” appears during a Normal scan.
 - When a signal is detected, the scan pauses until the signal disappears, or resumes after pausing 5 seconds, depending on the setting. (Channel 16 is still monitored during a Priority scan.)
 - Push [▲]/[▼] on either transceiver or microphone, to check the scanning Favorite channels, change the scanning direction or manually resume the scan.
 - A beep tone sounds and “16” blinks when a signal is received on Channel 16 during a Priority scan.
- ⑤ To stop the scan, push [CLEAR] or repeat step ④.

[Example]: Starting a Normal scan.

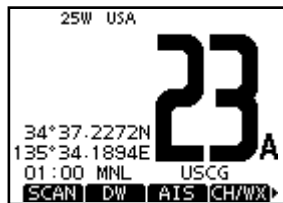

Push
[SCAN]

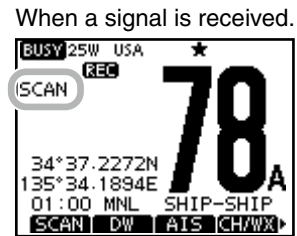
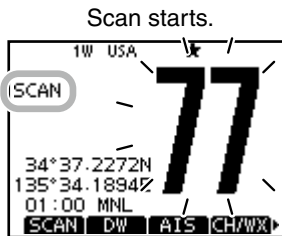

■ Description

Dualwatch monitors Channel 16 while you are receiving on another channel; Tri-watch monitors Channel 16 and the Call channel while receiving another channel. Dualwatch and Tri-watch are convenient for monitoring Channel 16 when you are operating on another channel.

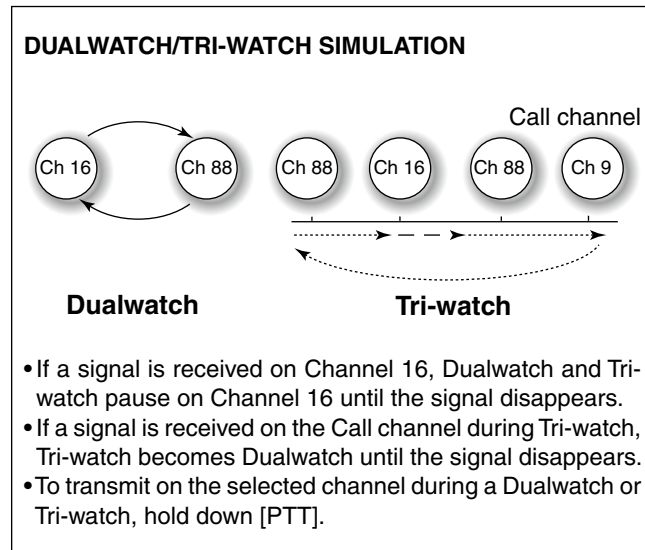

■ Operation

- ① Select Dualwatch or Tri-watch in the Menu screen. (p. 100)
- ② Rotate dial or push [▲](CH)/[▼](CH) to select the desired operating channel.
- ③ Push [DW] to start a Dualwatch or Tri-watch scan.
 - “DUAL 16” appears during Dualwatch; “TRI 16” appears during Tri-watch.
 - A beep tone sounds when a signal is received on Channel 16.
- ④ To cancel Dualwatch or Tri-watch, push [DW] again.

[Example]: Operating Tri-watch on USA Channel 25.

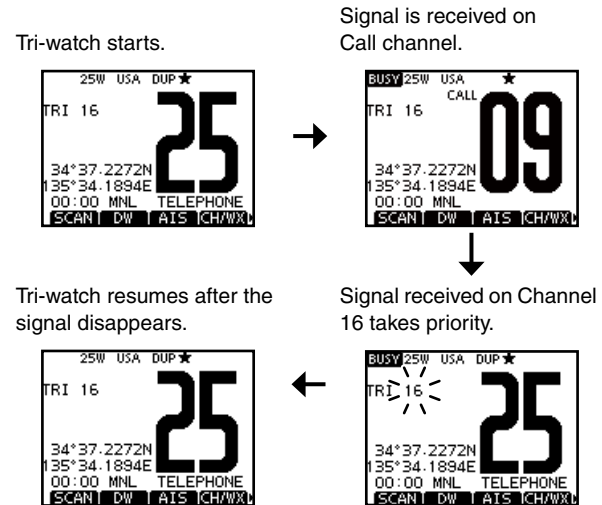

■ DSC address ID

◇ Programming Individual ID

A total of 100 DSC address IDs can be programmed and assigned a name of up to 10 characters.

- ① Enter “INDIVIDUAL ID” in the DSC SETTINGS menu.

<MENU> ⇄ <DSC SET> ⇄ <Individual ID>
 (Push [MENU]) (Select icon) (Rotate dial, then push [ENT].)

- ② Push [ADD].

• The “INDIVIDUAL ID” program screen is displayed.

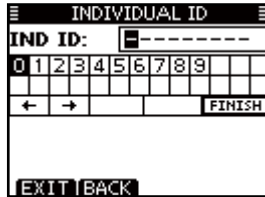

- ③ Enter a desired individual ID in the following way:

- Select a desired number using [▲]/[▼]/[◀]/[▶].
- Push [ENT] or dial to set it.
- To move the cursor, rotate dial or select either arrow, “←” or “→,” then push [ENT] or dial.
- Push [EXIT] to return to the normal operating mode.
- Push [BACK] to return to the previous screen.

▨ The first digit is specified as ‘0’ for a Group ID.

▨ The first two digits are ‘0’ for any Coast station ID.

- ④ Repeat step ③ to enter all 9 digits.

- ⑤ After entering the 9 digit code, push [ENT] or dial to set it.
- The ID name programming screen is displayed.



- ⑥ Enter a desired 10 digit ID name in the following way:

- Select a desired character using [▲]/[▼]/[◀]/[▶].
- Push [ENT] or dial to set it.
- To move the cursor, rotate dial or select either arrow, “←” or “→,” then push [ENT] or dial.
- Push [123], [!\$?] or [ABC] to select a character group.

- ⑦ After entering the ID name, select “FINISH” using [▲]/[▼]/[◀]/[▶], then push [ENT] to program it.

- The “INDIVIDUAL ID” list screen is displayed.



- ⑧ Push [MENU] to exit the MENU screen.

◆ Programming Group ID

- ① Enter “GROUP ID” in the DSC SETTINGS menu.

◀MENU▶ ⇄ ▶DSC SET▶ ⇄ ▶Group ID▶
 (Push [MENU]) (Select icon) (Rotate dial, then push [ENT].)

- ② Push [ADD].
 • The “GROUP ID” program screen is displayed.



- ③ Enter a desired group ID in the following way:
- Select a desired number using [▲]/[▼]/[◀]/[▶].
 - Push [ENT] or dial to set it.
 - To move the cursor, rotate dial or select either arrow, “←” or “→,” then push [ENT] or dial.
 - Push [EXIT] to return to the normal operating mode.
 - Push [BACK] to return to the previous screen.
- ▨ The first digit is fixed as ‘0’ for a Group ID.
 ▨ The first two digits are ‘0’ for any Coast station ID.
- ④ Repeat step ③ to input the specific 9 digits group code.

- ⑤ After entering the 9 digit code, push [ENT] or dial to set it.
 • The Group ID name programming screen is displayed.



- ⑥ Enter a desired 10 digit ID name in the following way:
- Select a desired character using [▲]/[▼]/[◀]/[▶].
 - Push [ENT] or dial to set it.
 - To move the cursor, rotate dial or select either arrow, “←” or “→,” then push [ENT] or dial.
 - Push [123], [!\$?] or [ABC] to select a character group.
- ⑦ After entering the ID name, select “FINISH” using [▲]/[▼]/[◀]/[▶], then push [ENT] or dial to program it.
 • The “GROUP ID” list screen is displayed.



- ⑧ Push [MENU] to exit the MENU screen.

7 DSC OPERATION

◇ Deleting Individual/Group ID

- ① Enter "INDIVIDUAL ID" or "GROUP ID" in the DSC SETTINGS menu.

◀MENU▶ ⇄ ▶DSC SET▶ ⇄ ▶Individual ID▶/◀Group ID▶
(Push [MENU]) (Select icon) (Rotate Dial, then push [ENT].)

• When no address ID is programmed, "No ID" is displayed. In this case, push [MENU] to exit the MENU screen.

- ② Rotate dial or push [▲]/[▼] to select a desired ID name, and then push [DEL].

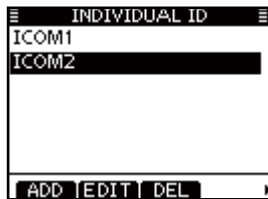

- ③ Push [OK] to delete the ID, and return to the "INDIVIDUAL ID" or "GROUP ID" list screen.
 - Push [CANCEL] to cancel it.



- ④ Push [MENU] to exit the MENU screen.

■ Position and time programming

A Distress call should include the ship's position and time. If no GPS is connected, your position and UTC (Universal Time Coordinated) time should be manually input. They are automatically included when a GPS receiver compatible with the NMEA 0183 (ver. 2.0 or later) or NMEA 2000* format is connected.

*Some versions of IC-M506 do not have a NMEA 2000 connector.

- Manual programming is disabled when a GPS receiver is connected.
- Manually programmed position and time will be held for only 23.5 hours.

① Enter "POSITION INPUT" in the DSC SETTINGS menu.

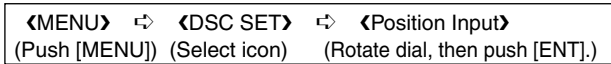

- ② Edit your latitude and longitude position using dial, and [▲]/[▼]/[◀]/[▶].
- Select a desired number using [▲]/[▼]/[◀]/[▶].
 - Push [ENT] or dial to set it.
 - To move the cursor, rotate dial or select either arrow, "←" or "→," then push [ENT] or dial.
 - Select N (North latitude) or S (South latitude) when the cursor is on the 'N' or 'S' position.
 - Select W (West longitude) or E (East longitude) when the cursor is on the 'W' or 'E' position.
 - Push [EXIT] to return to the normal operating mode.
 - Push [BACK] to return to the previous screen.

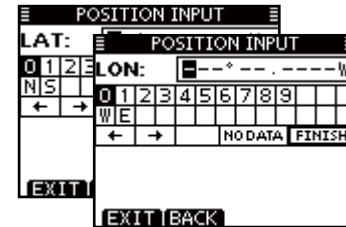

- ③ After entering the position, push [ENT] to program it.
- ④ The UTC time programming screen is displayed, enter the UTC time in the following way:
- Select a desired number using [▲]/[▼]/[◀]/[▶].
 - Push [ENT] or dial to set it.
 - To move the cursor, rotate dial or select either arrow, "←" or "→," then push [ENT] or dial.

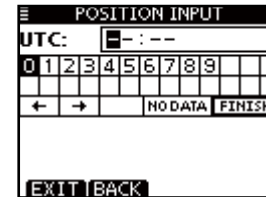

- ⑤ Push [ENT] or dial to program your position and time.
- Return to the "DSC SETTINGS" screen.

■ Distress call

A Distress call should be transmitted if, in the opinion of the Master, the ship or a person is in distress and requires immediate assistance.

NEVER MAKE A DISTRESS CALL IF YOUR SHIP OR A PERSON IS NOT IN AN EMERGENCY. A DISTRESS CALL SHOULD BE MADE ONLY WHEN IMMEDIATE HELP IS NEEDED.

◇ Simple call

- ① Confirm no Distress call is being received.
- ② While lifting up the key cover, hold down [DISTRESS] for 3 seconds to transmit the Distress call.
 - While holding down [DISTRESS], count down beeps sound and both the key and display backlighting blink.
 - DSC channel (Channel 70) is automatically selected and the Distress call is transmitted.



- ③ After transmitting the call, the transceiver waits for an acknowledgment call.
 - The Distress call is automatically transmitted every 3.5 to 4.5 minutes, until an acknowledgement is received ('Call repeat' mode), or DSC Cancel call is made. (p. 27)
 - Push [RESEND] to manually transmit the Distress repeat call.
 - Push [◀]/[▶] then push [INFO] to display the transmitted Distress call information.
 - Push [◀]/[▶] then push [PAUSE] to pause the 'Call repeat' mode, push [RESUME COUNTDOWN] to resume it.



- ④ After receiving the acknowledgment, push [ALARM OFF] then reply using the microphone.

➤ A distress alert default contains:

- Nature of distress: Undesignated distress
- Position information: The latest GPS or manual input position is held for 23.5 hours, or until the power is turned OFF.

◇ Regular call

The nature of the Distress call should be included in the Distress call.

- ① Push [DTRS] to enter "DISTRESS CALL" in the DSC menu.
- ② Select the nature of the distress using dial or [▲]/[▼], then push dial or [ENT].
 - 'Undesignated,' 'Fire,Explosion,' 'Flooding,' 'Collision,' 'Grounding,' 'Capsizing,' 'Sinking,' 'Adrift,' 'Abandoning ship,' 'Piracy' or 'Man Overboard' is selectable.
 - The nature of the distress is stored for 30 seconds after a selection is made.
 - Push [EXIT] to return to the normal operating mode.
 - Push [BACK] to return to the previous screen.

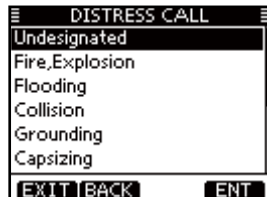

- ③ The Distress call confirmation screen is displayed.
 - Rotate dial or push [▲]/[▼] to see the hidden lines.



- ④ Hold down [DISTRESS] for 3 seconds to transmit the Distress call.
 - While holding down [DISTRESS], count down beeps sound and both the key and display backlighting blink.
 - The selected nature of the distress is stored for 30 seconds.

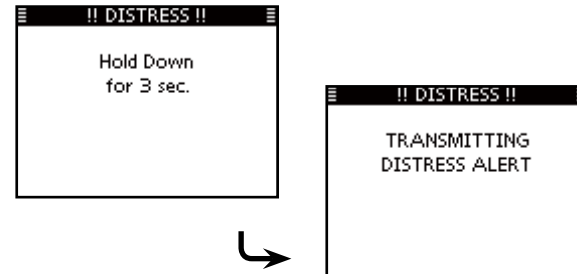

Continued on the next page.

7 DSC OPERATION

◇ Regular call (continued)

- ⑤ After transmitting the call, the transceiver waits for an acknowledgment call.
- The Distress call is automatically transmitted every 3.5 to 4.5 minutes, until an acknowledgement is received ('Call repeat mode'), or DSC cancel call is made. (p. 27)
 - Push [RESEND] to manually transmit the Distress repeat call.
 - Push [◀]/[▶] then push [INFO] to display the transmitted Distress call information.
 - Push [◀]/[▶] then push [PAUSE] to pause the 'Call repeat' mode, push [RESUME COUNTDOWN] to resume it.



- ⑥ After receiving an acknowledgment call, push [ALARM OFF] then reply using the microphone.



➔ A distress alert contains:

- Nature of distress: Selected in step ②.
- Position information: The latest GPS or manual input position is held for 23.5 hours, or until the power is turned OFF.

When no GPS receiver is connected, and both position and time have been manually programmed, the screen as shown below appears. Edit your latitude and longitude position and UTC time as follows:



- ➔ Push [CHG], then edit your latitude and longitude position and UTC time.
 - Select a desired number using [▲]/[▼]/[◀]/[▶].
 - Push [ENT] or dial to set it.
 - To move the cursor, rotate dial or select either arrow, “←” or “→,” then push [ENT] or Dial.
 - Select N (North latitude) or S (South latitude) when the cursor is on the ‘N’ or ‘S’ position.
 - Select W (West longitude) or E (East longitude) when the cursor is on the ‘W’ or ‘E’ position.

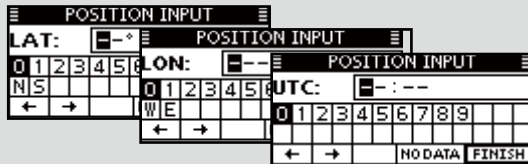

7 DSC OPERATION

◇ Distress cancel call

- ① While waiting for an acknowledgment call, push [CANCEL].



- ② Push [CONTINUE].

- Push [BACK] to return to waiting for an acknowledgement call.



- ③ Push [FINISH].

- Push [EXIT] to return to waiting for an acknowledgement call.

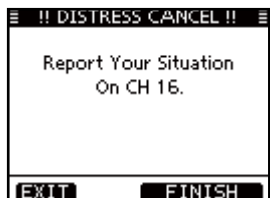

- ④ The Distress cancel call is transmitted.



- ⑤ Channel 16 is automatically selected.

- Report your situation using the microphone.
- After the report, push [EXIT] to return to the normal operating mode.*
- Push [RESEND] to resend the call.



Example: When transmitting an Individual call



*When you push [EXIT], the exit confirmation dialog is displayed.

◇ Transmitting a Distress Relay Acknowledgement

When receiving a Distress Relay Call, you can transmit an acknowledgement, as shown below.

- ① When a Distress Relay Call is received, an alarm sounds and the screen shown below is displayed.
Push [ALARM OFF] to stop the alarm.
 - Even if you do not push [ALARM OFF], the alarm stops after 2 minutes, and then the screen in step ② is displayed.



- ② Push [ACPT].
 - Even if you do not push [ACPT], the screen in step ③ is displayed after 10 seconds.
 - Push [IGN] to ignore the call and return to the normal operating mode.
 - Push [INFO] to display the Distress Relay Call information.
 - Push [PAUSE] to pause the countdown.



About Received call information:

- Push [IGN] to ignore the call and return to the normal operating mode.
- Push [BACK] to return to the previous screen.
- Push [ACPT] to go to the next step.



- ③ Push [ACK].
 - Push [EXIT] to return to the normal operating mode.*
 - *The exit confirmation dialog is displayed.

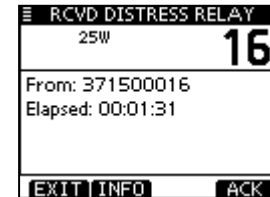

7 DSC OPERATION

- ④ The Distress Relay Acknowledgement confirmation screen is displayed.

Push [CALL] to transmit the acknowledgement call.

- Push [EXIT] to return to the normal operating mode.*

*The exit confirmation dialog (p. 27) is displayed.

- Push [BACK] to return to the previous screen.



- ⑤ The Distress Relay Acknowledgement is transmitted.



- ⑥ Channel 16 is automatically selected.

- Push [EXIT] to return to the normal operating mode.*

*The exit confirmation dialog (p. 27) is displayed.

- Push [RESEND] to resend the acknowledgement.

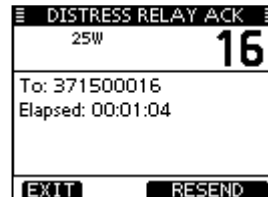

■ Transmitting DSC calls

/// To ensure correct operation of the DSC function, make sure you correctly set the CH70 SQL Level. (p. 73)

◇ Transmitting an individual call

The Individual call function allows you to transmit a DSC signal to only a specific station.

- 1 Enter "INDIVIDUAL CALL" in the DSC CALLS menu.

◀MENU▶ ⇄ ◀DSC▶ ⇄ ◀Individual Call▶
 (Push [MENU]) (Select icon) (Rotate dial, then push [ENT].)

- 2 Select the desired pre-programmed individual address, or "Manual Input," using dial or [▲]/[▼], then push [ENT].
 - The ID code for the Individual call can be set first. (p. 19)
 - When "Manual Input" is selected, set a desired 9 digit MMSI ID code for the individual you wish to call.
 - Push [EXIT] to return to the normal operating mode.
 - Push [BACK] to return to the previous screen.

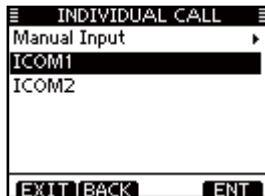

/// About Manual Inputting:

Enter a desired individual ID in the following way:

- Select a desired number using [▲]/[▼]/[◀]/[▶].
- Push [ENT] or dial to set it.
- To move the cursor, rotate dial or select either arrow, "←" or "→," then push [ENT] or dial.
- The first digit is specified as '0' for a Group ID. If a 9 digit Group ID is entered, an error beep sounds when pushing [ENT] or dial.
- The first two digits are '0' for any coast station ID.



/// **NOTE:** When a coast station is selected in step ②, the voice channel is automatically specified by the coast station. Therefore, skip step ③ and go directly to step ④.

Continued on the next page.

7 DSC OPERATION

◇ Transmitting DSC calls (continued)

- ③ Select a desired intership channel using dial or [▲](CH)/[▼](CH), then push [ENT].
- Intership channels are already preset into the transceiver in the recommended order.

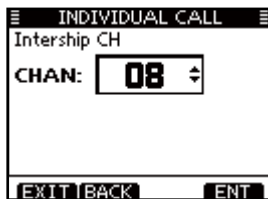

- ④ A confirmation screen is displayed.
- Confirm the call contents.

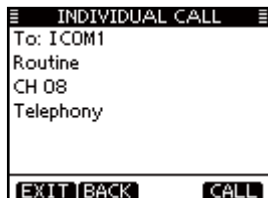

- ⑤ Push [CALL] to transmit the Individual call.
- If Channel 70 is busy, the transceiver stands by until the channel becomes clear.



- ⑥ Standby on Channel 70 until an acknowledgement is received.
- Push [EXIT] to return to the normal operating mode.*
 - *The exit confirmation dialog (p. 27) is displayed.
 - Push [RESEND] to resend the call.

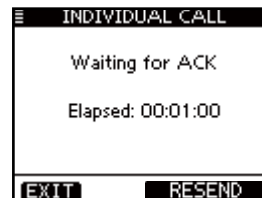

- ⑦ When the acknowledgement 'Able to comply' is received, alarm sounds and the screen below is displayed.



Push [ALARM OFF] to stop the alarm and then select the intership channel specified in step ③.

- A different intership channel will be selected if the station you called cannot use the channel.
- Reply using the microphone. And go to step ⑧.



Or, when the acknowledgement 'Unable to comply' is received, alarm sounds and the screen below is displayed.



Push [ALARM OFF] to stop the alarm. Then push [EXIT] to return to the operating channel (before you entered the MENU screen).

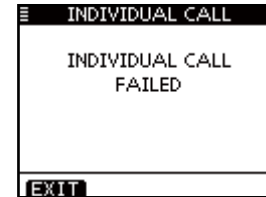

- ⑧ After communicating, push [EXIT] to return to the normal operating mode.*

*The exit confirmation dialog (p. 27) is displayed.

✓ **Convenient!**

When the optional MA-500TR CLASS B AIS TRANSPONDER is connected to your transceiver, you can transmit individual DSC calls to selected AIS targets on the transponder without needing to enter the target's MMSI code. See pages 72 and 102 for more details.

7 DSC OPERATION

◇ Transmitting an Individual Acknowledgement

When receiving an Individual call, you can transmit an acknowledgement ('Able to Comply,' 'Propose New Channel' or 'Unable to Comply') by using the on-screen prompts (Quick ACK.) Also, you can send an acknowledgement through the MENU system (Manual ACK.)

Quick ACK:

① When an Individual call is received, alarm sounds and the screen below is displayed.

Push [ALARM OFF] to stop the alarm.

- Even if you do not push [ALARM OFF], the alarm stops after 2 minutes, and then the screen in step ② is displayed.



② Push [ACK].

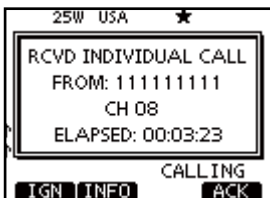

- ③ Select one of three options, then push [ENT].
- Push [EXIT] to return to the normal operating mode.
 - Push [BACK] to return to the previous screen.

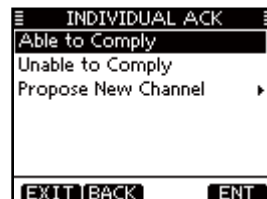

- Able to Comply: Make an acknowledgment call without any changes.
- Unable to Comply: You cannot make a communication. The Acknowledgement call ('Unable to Comply') can be automatically transmitted, if set. See page 68 for details.
- Propose New Channel: You can make an acknowledgement call, but you specify the intership channel. Select a desired intership channel, using dial, or [▲](CH)/[▼](CH), then push [ENT].



- ④ The Individual ACK confirmation screen is displayed.
Push [CALL] to transmit an acknowledgement call.

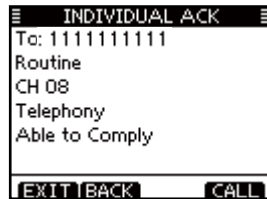

- ⑤ The screens shown below are displayed.

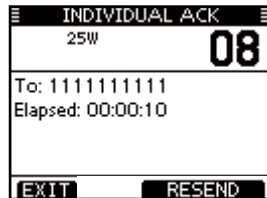

- ⑥ Reply to the call using the microphone.
⑦ Push [EXIT] to return to the normal operating mode.*
*The exit confirmation dialog (p. 27) is displayed.
• Push [RESEND] to resend the acknowledgement.

Manual ACK:

- ① Enter "INDIVIDUAL ACK" in the DSC CALLS menu.

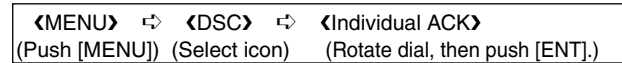

- When no Individual call has been received, "Individual ACK" item will not be displayed.
- ② Select a desired individual address or ID name to reply to, using dial or [▲]/[▼], then push [ENT].
- Push [EXIT] to return to the normal operating mode.
 - Push [BACK] to return to the previous screen.



- ③ Perform steps ③ to ⑦, as described in "Quick ACK:," beginning on the previous page.

7 DSC OPERATION

◇ Transmitting a Group call

The Group call function allows you to transmit a DSC signal to only a specific group.

- ① Enter “GROUP CALL” in the DSC CALLS menu.

◀MENU▶ ⇄ ▶DSC▶ ⇄ ▶Group Call▶
(Push [MENU]) (Select icon) (Rotate dial, then push [ENT].)

- ② Select the desired pre-programmed group address or “Manual Input,” using dial or [▲]/[▼], then push [ENT].
 - The ID code for the Group call can be set first. (p. 20)
 - When “Manual Input” is selected, set the 8 digit ID code for the group you wish to call.
 - Push [EXIT] to return to the normal operating mode.
 - Push [BACK] to return to the previous screen.

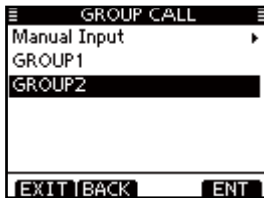

- ③ Select a desired intership channel using dial or [▲](CH)/[▼](CH), then push [ENT].
 - Intership channels are already preset into the transceiver in the recommended order.



▨ About Manual Inputting:

Enter a desired group ID in the following way:

- Select a desired number using [▲]/[▼]/[◀]/[▶].
- Push [ENT] or dial to set it.
- To move the cursor, rotate dial or select either arrow, “←” or “→,” then push [ENT] or dial.
- The first digit is specified as ‘0’ for a Group ID.
- The first two digits are ‘0’ for any Coast station ID.



- ④ A confirmation screen is displayed.
- Confirm the call contents.



- ⑤ Push [CALL] to transmit the Group call.
- If Channel 70 is busy, the transceiver stands by until the channel becomes clear.



- ⑥ After the Group call has been transmitted, the following screen is displayed.



- ⑦ Announce the information using the microphone.
- ⑧ After the announcement, push [EXIT] to return to the normal operating mode.*
- *The exit confirmation dialog (p. 27) is displayed.
 - Push [RESEND] to resend the call.

7 DSC OPERATION

◇ Transmitting an All Ships call

All ships, that have DSC transceiver, use Channel 70 as their 'listening channel.' When you want to announce a message to these ships within range, use the 'All Ships Call' function.

- ① Enter "ALL SHIPS CALL" in the DSC CALLS menu.

◀MENU▶	↔	◀DSC▶	↔	◀All Ships Call▶
(Push [MENU])		(Select icon)		(Rotate dial, then push [ENT].)

- ② Select a desired category, using dial or [▲]/[▼], then push [ENT].

- The selectable category may differ, depending on the programmed setting. Ask your dealer for the selectable categories.
- Push [EXIT] to return to the normal operating mode.
- Push [BACK] to return to the previous screen.

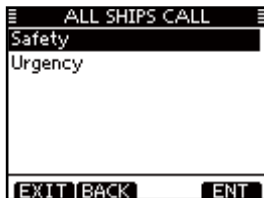

- ③ Select a desired traffic channel, using dial or [▲]/[▼], then push [ENT].

- The selected channel is displayed.

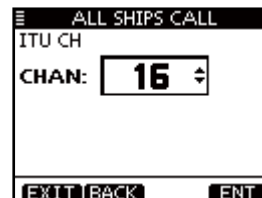

- ④ A confirmation screen is displayed.

- Confirm the call contents.

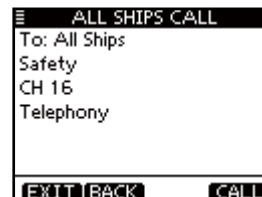

- ⑤ Push [CALL] to transmit the All Ships call.
- If Channel 70 is busy, the transceiver stands by until the channel becomes clear.



- ⑥ After the All Ships call has been transmitted, the following screen is displayed.

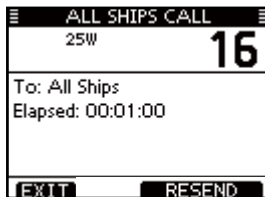

- ⑦ Announce the message using the microphone.
- ⑧ After the announcement, push [EXIT] to return to the normal operating mode.*
- *The exit confirmation dialog (p. 27) is displayed.
 - Push [RESEND] to resend the call.

7 DSC OPERATION

◇ Transmitting a Position Request Call

Transmit a Position Request Call when you want to know a specific ship's current position, etc.

- 1 Enter "POSITION REQUEST" in the DSC CALLS menu.

◀MENU▶ ⇄ ▶DSC▶ ⇄ ▶Position Request▶
(Push [MENU]) (Select icon) (Rotate dial, then push [ENT].)

- 2 Select the desired pre-programmed individual address, or "Manual Input," using dial or [▲]/[▼], then push [ENT].
 - The ID code for the Position Request Call can be set first. (p. 19)
 - When "Manual Input" is selected, set a desired 9 digit MMSI ID code for the individual you wish to call.
 - Push [EXIT] to return to the normal operating mode.
 - Push [BACK] to return to the previous screen.

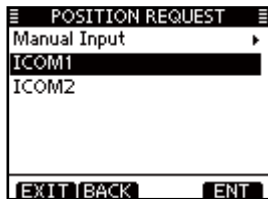

About Manual Inputting:

Enter a desired individual ID in the following way:

- Select a desired number using [▲]/[▼]/[◀]/[▶].
- Push [ENT] or dial to set it.
- To move the cursor, rotate dial or select either arrow, "←" or "→," then push [ENT] or dial.
- The first digit is specified as '0' for a Group ID. If a 9 digit Group ID is entered, an error beep sounds when pushing [ENT] or dial.
- The first two digits are '0' for any coast station ID.



- 3 A confirmation screen is displayed.
 - Confirm the call contents.



- ④ Push [CALL] to transmit the Position Request Call.
- If Channel 70 is busy, the transceiver stands by until the channel becomes clear.



- ⑤ After the Position Request Call has been transmitted, the following screen is displayed.
- Push [EXIT] to return to the normal operating mode.*
 - *The exit confirmation dialog (p. 27) is displayed.
 - Push [RESEND] to resend the call.



- ⑥ When the acknowledgement call is received, alarm sounds and the following screen is displayed.



- ⑦ Push [ALARM OFF] to stop the alarm, and then the screen as shown below is displayed.



- ⑧ Push [EXIT] to return to the normal operating mode.*
- *The exit confirmation dialog (p. 27) is displayed.

7 DSC OPERATION

◆ Transmitting a Position Report Call

Transmit a Position Report Call when you want to announce your own position to a specific ship.

- ① Enter "POSITION REPORT" in the DSC CALLS menu.

◀MENU▶ ⇄ ▶DSC▶ ⇄ ▶Position Report▶
(Push [MENU]) (Select icon) (Rotate dial, then push [ENT].)

- ② Select the desired pre-programmed individual address, or "Manual Input," using dial or [▲]/[▼], then push [ENT].
 - The ID code for the Individual call can be set first. (p. 19)
 - When "Manual Input" is selected, set a desired 9 digit MMSI ID code for the individual you wish to call.
 - Push [EXIT] to return to the normal operating mode.
 - Push [BACK] to return to the previous screen.

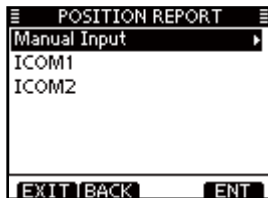

About Manual Inputting:

Enter a desired individual ID in the following way:

- Select a desired number using [▲]/[▼]/[◀]/[▶].
- Push [ENT] or dial to set it.
- To move the cursor, rotate dial or select either arrow, "←" or "→," then push [ENT] or dial.
- The first digit is specified as '0' for a Group ID. If a 9 digit Group ID is entered, an error beep sounds when pushing [ENT] or dial.
- The first two digits are '0' for any coast station ID.



- ③ A confirmation screen is displayed.
 - Confirm the call contents.



- ④ Push [CALL] to transmit the Position Report Call.
- If Channel 70 is busy, the transceiver stands by until the channel becomes clear.



- ⑤ After the Position Report Call has been transmitted, the transceiver automatically returns to the normal operating mode.

When no GPS receiver is connected, and both position and time have been manually programmed, the screen shown below is displayed. Edit your latitude and longitude position and UTC time as follows:



- ➔ Push [CHG], then edit your latitude and longitude position and UTC time.
- Select a desired number using [▲]/[▼]/[◀]/[▶].
 - Push [ENT] or dial to set it.
 - To move the cursor, rotate dial or select either arrow, “←” or “→,” then push [ENT] or dial.
 - Select N (North latitude) or S (South latitude) when the cursor is on the ‘N’ or ‘S’ position.
 - Select W (West longitude) or E (East longitude) when the cursor is on the ‘W’ or ‘E’ position.

7 DSC OPERATION

◆ Transmitting a Polling Request Call

Transmit a Polling Request Call when you want to know a specific vessel is in the communication area, or not.

- ① Enter “POLLING REQUEST” in the DSC CALLS menu.

◀MENU▶ ⇄ ▶DSC▶ ⇄ ▶Polling Request▶
(Push [MENU]) (Select icon) (Rotate dial, then push [ENT].)

- ② Select the desired pre-programmed individual address, or “Manual Input,” using dial or [▲]/[▼], then push [ENT].
 - The ID code for the Individual call can be set first. (p. 19)
 - When “Manual Input” is selected, set a desired 9 digit MMSI ID code for the individual you wish to call.
 - Push [EXIT] to return to the normal operating mode.
 - Push [BACK] to return to the previous screen.

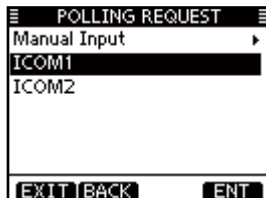

▨ About Manual Inputting:

Enter a desired individual ID in the following way:

- Select a desired number using [▲]/[▼]/[◀]/[▶].
- Push [ENT] or dial to set it.
- To move the cursor, rotate dial or select either arrow, “←” or “→,” then push [ENT] or dial.
- The first digit is specified as ‘0’ for a Group ID. If a 9 digit Group ID is entered, an error beep sounds when pushing [ENT] or dial.
- The first two digits are ‘0’ for any coast station ID.

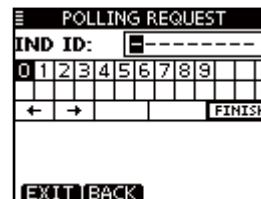

- ③ A confirmation screen is displayed.
 - Confirm the call contents.

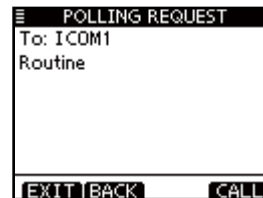

- ④ Push [CALL] to transmit the Polling Request Call.
- If Channel 70 is busy, the transceiver stands by until the channel becomes clear.



- ⑤ After the Polling Request Call has been transmitted, the following screen is displayed.
- Push [EXIT] to return to the normal operating mode.*
 - *The exit confirmation dialog (p. 27) is displayed.
 - Push [RESEND] to resend the call.

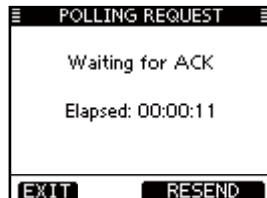

- ⑥ When the acknowledgement call is received, alarm sounds and the following screen is displayed.



- ⑦ Push [ALARM OFF] to stop the alarm, and then the screen as shown below is displayed.

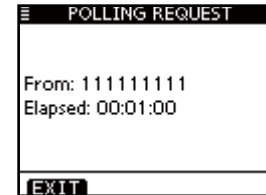

- ⑧ Push [EXIT] to return to the normal operating mode.*
- *The exit confirmation dialog (p. 27) is displayed.

7 DSC OPERATION

◇ Transmitting a Test call

Testing on the exclusive DSC distress and safety calling channels should be avoided as much as possible. When testing on a distress/safety channel is unavoidable, you should indicate that these are test transmissions.

Normally the test call would require no further communications between the two stations involved.

- 1 Enter "TEST CALL" in the DSC CALLS menu.

◀MENU▶ ⇄ ▶DSC▶ ⇄ ▶Test Call▶
(Push [MENU]) (Select icon) (Rotate dial, then push [ENT].)

- 2 Select a desired pre-programmed individual address, or "Manual Input," then push dial or [ENT].
 - The ID code for the Individual call can be set first. (p. 19)
 - When "Manual Input" is selected, set the 9 digit MMSI ID code for the individual you wish to call.
 - Push [EXIT] to return to the normal operating mode.
 - Push [BACK] to return to the previous screen.

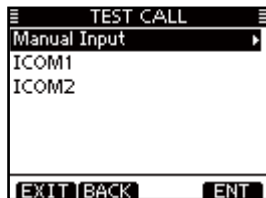

▨ About Manual Inputting:

Enter a desired address ID in the following way:

- Select a desired number using [▲]/[▼]/[◀]/[▶].
- Push [ENT] or dial to set it.
- To move the cursor, rotate dial or select either arrow, "←" or "→," then push [ENT] or dial.
- The first digit is specified as '0' for a Group ID. If a 9 digit Group ID is entered, an error beep sounds when pushing [ENT] or dial.
- The first two digits are '0' for any Coast station ID.



- 3 A confirmation screen is displayed.
 - Confirm the call contents.

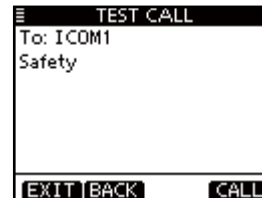

- ④ Push [CALL] to transmit the Test call.
- If Channel 70 is busy, the transceiver stands by until the channel becomes clear.



- ⑤ After the Test call has been transmitted, the following screen is displayed.
- Push [EXIT] to return to the normal operating mode.*
 - *The exit confirmation dialog (p. 27) is displayed.
 - Push [RESEND] to resend the call.

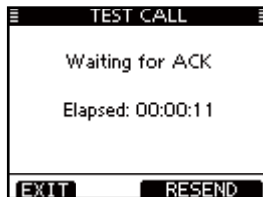

- ⑥ When the acknowledgement call is received, alarm sounds and the following screen is displayed.



- ⑦ Push [ALARM OFF] to stop the alarm, and then the screen as shown below is displayed.

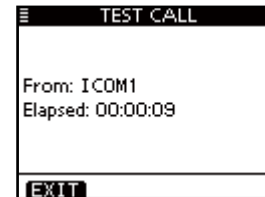

- ⑧ Push [EXIT] to return to the normal operating mode.*
- *The exit confirmation dialog (p. 27) is displayed.

7 DSC OPERATION

◇ Transmitting a Test Acknowledgement call

When the "TEST ACK" in DSC settings is set to 'Auto' (p. 70), the transceiver automatically transmits a reply call when receiving a Test call.

Quick ACK:

① When a Test call is received, alarm sounds and the screen shown below is displayed.

Push [ALARM OFF] to stop the alarm.

- Even if you do not push [ALARM OFF], the alarm stops after 2 minutes, and then the screen in step ② is displayed.



② Push [ACK].

- Push [IGN] to ignore the call and return to the normal operating mode.
- Push [INFO] to display the Test call information.

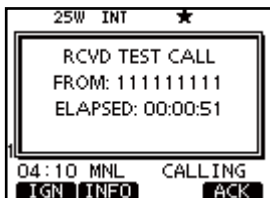

/// About Received call information:

- Push [IGN] to ignore the call and return to the normal operating mode.
- Push [BACK] to return to the previous screen.
- Push [ACK] to go to the next step.



③ The Test ACK confirmation screen is displayed.

Push [CALL] to transmit the acknowledgement call.

- Push [EXIT] to return to the normal operating mode.

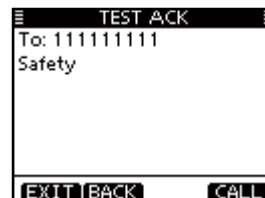

④ While transmitting the acknowledgement call, the screen shown below is displayed, and then returns to the normal operating mode.



Manual ACK:

① Enter “TEST ACK” in the DSC CALLS menu.

◀MENU> ⇄ ▶DSC> ⇄ ▶Test ACK
 (Push [MENU]) (Select icon) (Rotate dial, then push [ENT].)

- If no Test call has been received, the “Test ACK” item will not be displayed.
- Push [EXIT] to return to the normal operating mode.
- Push [BACK] to return to the previous screen.



② Select a desired Test call to reply to, using dial or [▲]/[▼], then push [ENT].



③ The Test ACK confirmation screen is displayed. Push [CALL] to transmit the acknowledgement call.



④ While transmitting the acknowledgement call, the screen shown below is displayed, and then returns to the normal operating mode.



7 DSC OPERATION

◆ Transmitting a Position Reply call

Transmit a Position Reply call when a Position Request call is received.

When the "POSITION ACK" in DSC Settings is set to 'Auto' (p. 70), the transceiver automatically transmits a reply call when receiving a Position Request call.

Quick Reply:

- ① When a Position Request call is received, alarm sounds and the screen shown below is displayed.

Push [ALARM OFF] to stop the alarm.

- Even if you do not push [ALARM OFF], the alarm stops after 2 minutes, and then the screen in step ② is displayed.

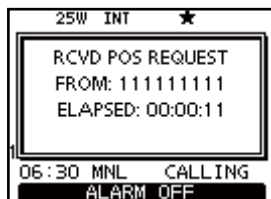

- ② Push a softkey to select your desired action.

- Push [IGN] to ignore the call and return to the normal operating mode.
- Push [INFO] to display the Position Request call information.
- Push [UNABLE] or [ABLE] to go to step ④ and then send an acknowledgement.



/// About Received call information:

- Push [IGN] to ignore the call and return to the normal operating mode.
- Push [BACK] to return to the previous screen.
- Push [ACK] to go to the next step.



- ③ The Position Reply confirmation screen is displayed.

Push [CALL] to transmit the reply call.

- Push [EXIT] to return to the normal operating mode.



- ④ While transmitting the reply call, the screen shown below is displayed, and then returns to the normal operating mode.



Manual Reply:

① Enter “POSITION REPLY” in the DSC CALLS menu.

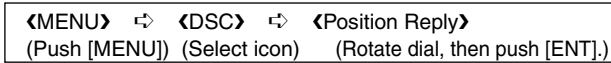

- If no Position Request call has been received, the “Position Reply” item will not be displayed.
- Push [BACK] to return to the previous screen.
- Push [EXIT] to return to the normal operating mode.



② Select a desired Position Request call to reply to, using dial or [▲]/[▼], then push [ENT].



③ The Position Reply call confirmation screen is displayed. Push [CALL] to transmit the acknowledgement call.



④ While transmitting the reply call, the screen shown below is displayed, and then returns to the normal operating mode.



When no GPS receiver is connected, and both position and time have been manually programmed, the screen shown below is displayed. Edit your latitude and longitude position and UTC time as follows:



- Push [CHG], then edit your latitude and longitude position and UTC time.
 - Select a desired number using [▲]/[▼]/[◀]/[▶].
 - Push [ENT] or dial to set it.
 - To move the cursor, rotate dial or select either arrow, “←” or “→,” then push [ENT] or dial.
 - Select N (North latitude) or S (South latitude) when the cursor is on the ‘N’ or ‘S’ position.
 - Select W (West longitude) or E (East longitude) when the cursor is on the ‘W’ or ‘E’ position.

7 DSC OPERATION

◇ Transmitting a Position Report Reply call

Transmit a Position Report Reply call when a Position Report call is received.

Quick Reply:

- ① When a Position Report Request is received, alarm sounds and the screen shown below is displayed.
Push [ALARM OFF] to stop the alarm.
 - Even if you do not push [ALARM OFF], the alarm stops after 2 minutes, and then the screen in step ② is displayed.



- ② Push [ACK].
 - Push [EXIT] to return to the normal operating mode.
 - Push [INFO] to display the Position Report Request call information.



/// About Received call information:

- Push [EXIT] to return to the normal operating mode.
- Push [BACK] to return to the previous screen.
- Push [ACK] to go to the next step.



- ③ The Position Report Reply confirmation screen is displayed.
Push [CALL] to transmit the reply call.



- ④ While transmitting the reply call, the screen shown below is displayed, and then returns to the normal operating mode.



Manual Reply:

- ① Enter “REPORT REPLY” in the DSC CALLS menu.

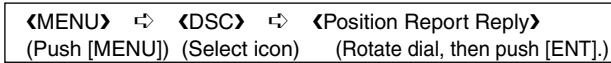

- If no Position Report Request call has been received, the “Position Report Reply” item will not be displayed.
- Push [BACK] to return to the previous screen.
- Push [EXIT] to return to the normal operating mode.



- ② Select a desired Position Report Request call to reply to, using dial or [▲]/[▼], then push [ENT].

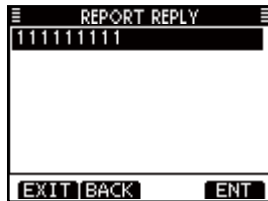

- ③ The Position Report Reply call confirmation screen is displayed.

Push [CALL] to transmit the acknowledgement call.



- ④ While transmitting the reply call, the screen shown below is displayed, and then returns to the normal operating mode.



7 DSC OPERATION

◇ Transmitting a Polling Request Reply call

Transmit a Polling Request Reply call when a Polling Request call is received.

When the "POSITION ACK" in DSC Settings is set to 'Auto' (p. 70), the transceiver automatically transmits a reply call when receiving a Polling Request call.

Quick Reply:

- ① When a Polling Request call is received, alarm sounds and the screen shown below is displayed.

Push [ALARM OFF] to stop the alarm.

- Even if you do not push [ALARM OFF], the alarm stops after 2 minutes, and then the screen in step ② is displayed.

- ② Push [ACK].

- Push [IGN] to ignore the call and return to the normal operating mode.
- Push [INFO] to display the Polling Request call information.

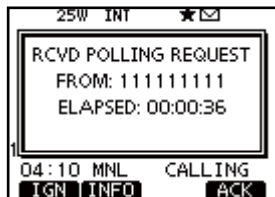
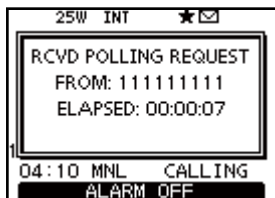

/// About Received call information:

- Push [IGN] to ignore the call and return to the normal operating mode.
- Push [BACK] to return to the previous screen.
- Push [ACK] to go to the next step.



- ③ The Polling Request Reply confirmation screen is displayed.

Push [CALL] to transmit the reply call.

- Push [EXIT] to return to the normal operating mode.

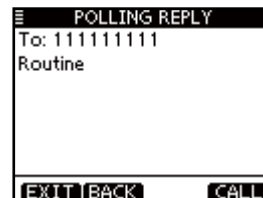

- ④ While transmitting the reply call, the screen shown below is displayed, and then returns to the normal operating mode.



Manual Reply:

- ① Enter “POLLING REPLY” in the DSC CALLS menu.

◀MENU▶ ⇄ ◀DSC▶ ⇄ ◀Polling Reply▶
 (Push [MENU]) (Select icon) (Rotate dial, then push [ENT].)

- If no Polling Request call has been received, the “Polling Reply” item will not be displayed.
- Push [BACK] to return to the previous screen.
- Push [EXIT] to return to the normal operating mode.



- ② Select a desired Polling Request call to be replied, using dial or [▲]/[▼], then push [ENT].

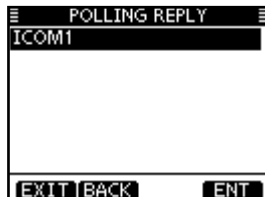

- ③ The Polling Request Reply call confirmation screen is displayed.

Push [CALL] to transmit the acknowledgement call.

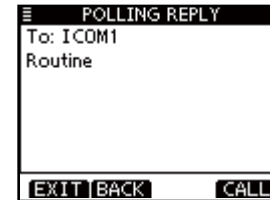

- ④ While transmitting the reply call, the screen shown below is displayed, and then returns to the normal operating mode.



■ Receiving DSC calls

◇ Receiving a Distress Call

When a Distress Call is received:

- The emergency alarm sounds for 2 minutes.
- “RCVD DISTRESS” appears and the backlight blinks.

- ① Push [ALARM OFF] to stop the alarm and the blinking backlight.
 - Even if you do not push [ALARM OFF], the alarm stops after 2 minutes, and then the screen in step ② is displayed.

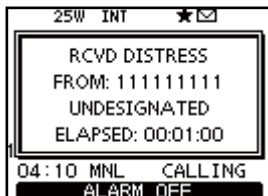

- ② Push a softkey to select your desired action.

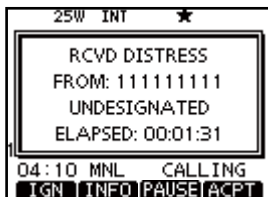

[IGN]

- Push to return to the normal operating mode.
 - The transceiver exits the DSC mode.
 - By pushing [PTT], the transceiver also exits the DSC mode.
 - The “✉” icon continues to blink and the Call is stored in the Received Call Log.

[INFO]

- Push to display the Received call information. (p. 67)

[PAUSE]

- Push to pause the countdown.
 - The softkey is displayed if the “CH Auto Switch:” item in the DSC SET menu (p. 71) is set to “10 sec.”
 - Push [RESUME] to resume the countdown.
 - The call is saved in the received call log.

[ACPT]

- Push to accept the call.

And then, push [CH 16] to switch the operating channel to Channel 16, and then monitor it, as a coast station may require assistance.

 - Even if you haven’t pushed [CH 16] within 10 seconds, the operating channel automatically switches to Channel 16. (p. 71)
 - Push [EXIT] to return to the normal operating mode.*
- *The exit confirmation dialog (p. 27) is displayed.

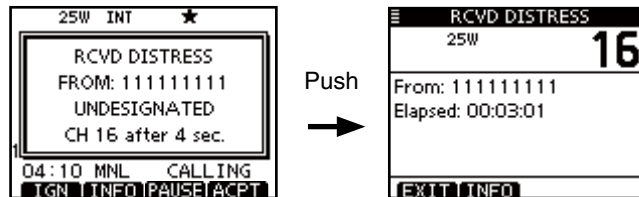

◇ Receiving a Distress Acknowledgement

When a Distress Acknowledgement sent to another ship is received:

- The emergency alarm sounds for 2 minutes.
- “RCVD DISTRESS ACK” appears and the backlight blinks.

- ① Push [ALARM OFF] to stop the alarm and the blinking backlight.
 - Even if you do not push [ALARM OFF], the alarm stops after 2 minutes, and then the screen in step ② is displayed.



- ② Push a softkey to select your desired action.



[IGN]

- Push to return to the normal operating mode.
 - The transceiver exits the DSC mode.
 - By pushing [PTT], the transceiver also exits the DSC mode.
 - The “✉” icon continues to blink and the Call is stored in the Received Call Log.

[INFO]

- Push to display the Received call information. (p. 67)

[PAUSE]

- Push to pause the countdown.
 - The softkey is displayed if the “CH Auto Switch:” item in the DSC SET menu (p. 71) is set to “10 sec.”
 - Push [RESUME] to resume the countdown.
 - The call is saved in the received call log.

[ACPT]

- Push to accept the call.

And then, push [CH 16] to switch the operating channel to Channel 16, and then monitor it, as a coast station may require assistance.

 - Even if you haven’t pushed [CH 16] within 10 seconds, the operating channel automatically switches to Channel 16. (p. 71)
 - Push [EXIT] to return to the normal operating mode.*

*The exit confirmation dialog (p. 27) is displayed.

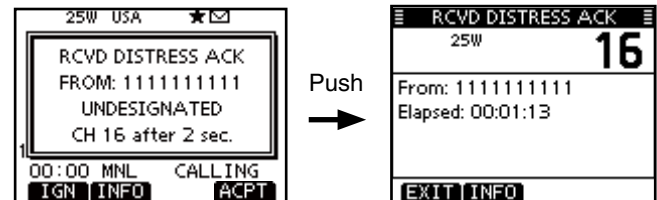

7 DSC OPERATION

◇ Receiving a Distress Relay Call

When a Distress Relay call is received:

- The emergency alarm sounds for 2 minutes.
- “RCVD DISTRESS RELAY” appears and the backlight blinks.

- ① Push [ALARM OFF] to stop the alarm and the blinking backlight.
 - Even if you do not push [ALARM OFF], the alarm stops after 2 minutes, and then the screen in step ② is displayed.



- ② Push a softkey to select your desired action.

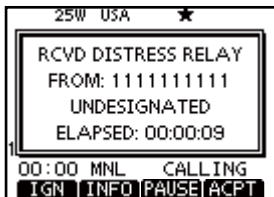

[IGN]

- Push to return to the normal operating mode.
 - The transceiver exits the DSC mode.
 - By pushing [PTT], the transceiver also exits the DSC mode.
 - The “” icon continues to blink and the Call is stored in the Received Call Log.

[INFO]

- Push to display the Received call information. (p. 67)

[PAUSE]

- Push to pause the countdown.
 - The softkey is displayed if the “CH Auto Switch:” item in the DSC SET menu (p. 71) is set to “10 sec.”
 - Push [RESUME] to resume the countdown.
 - The call is saved in the received call log.

[ACPT]

- Push to accept the call.

And then, push [CH 16] to switch the operating channel to Channel 16, and then monitor it, as a coast station may require assistance.

 - Even if you haven't pushed [CH 16] within 10 seconds, the operating channel automatically switches to Channel 16. (p. 71)
 - Push [EXIT] to return to the normal operating mode.*

*The exit confirmation dialog (p. 27) is displayed.

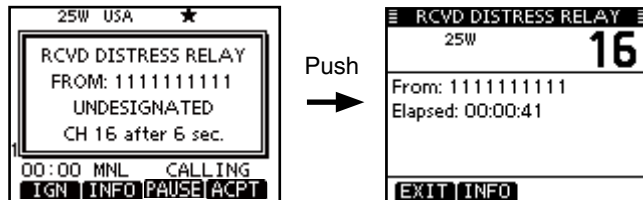

◇ **Receiving a Distress Relay Acknowledgement**

When a Distress Relay Acknowledgement is received:

- The emergency alarm sounds for 2 minutes.
- “RCVD DTRS RELAY ACK” appears and the backlight blinks.

- ① Push [ALARM OFF] to stop the alarm and the blinking backlight.
 - Even if you do not push [ALARM OFF], the alarm stops after 2 minutes, and then the screen in step ② is displayed.



- ② Push a softkey to select your desired action.



[IGN]

- Push to return to the normal operating mode.
 - The transceiver exits the DSC mode.
 - By pushing [PTT], the transceiver also exits the DSC mode.
 - The “✉” icon continues to blink and the Call is stored in the Received Call Log.

[INFO]

- Push to display the Received call information. (p. 67)

[PAUSE]

- Push to pause the countdown.
 - The softkey is displayed if the “CH Auto Switch:” item in the DSC SET menu (p. 71) is set to “10 sec.”
 - Push [RESUME] to resume the countdown.
 - The call is saved in the received call log.

[ACPT]

- Push to accept the call.

And then, push [CH 16] to switch the operating channel to Channel 16, and then monitor it, as a coast station may require assistance.

 - Even if you haven’t pushed [CH 16] within 10 seconds, the operating channel automatically switches to Channel 16. (p. 71)
 - Push [EXIT] to return to the normal operating mode.*

*The exit confirmation dialog (p. 27) is displayed.

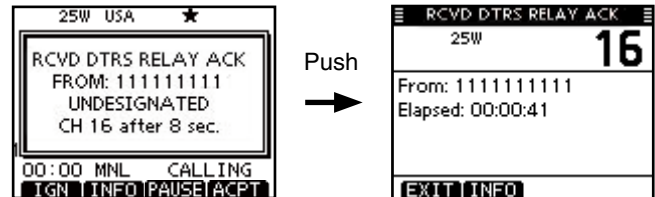

7 DSC OPERATION

◇ Receiving an Individual Call

When an Individual Call is received:

- The alarm sounds for 2 minutes.
- “RCVD INDIVIDUAL CALL” appears. The backlight may blink for 2 minutes, depending on the received Category.

- ① Push [ALARM OFF] to stop the alarm and the blinking backlight.
 - Even if you do not push [ALARM OFF], the alarm stops after 2 minutes, and then the screen in step ② is displayed.

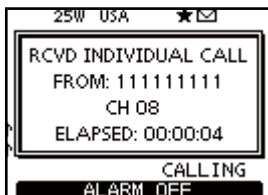

- ② Push a softkey to select your desired action.

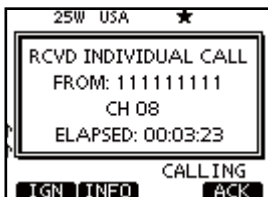

[IGN]

- Push to ignore the Call and return to the normal operating mode.
 - The transceiver exits the DSC mode.
 - The “✉” icon continues to blink and the Call is stored in the Received Call Log.

[INFO]

- Push to display the Received call information. (p. 67)

[ACK]

- Push to display the “INDIVIDUAL ACK” screen to reply to the Call. Select one of three options, depending on your situation. See page 31 for details of the Individual Acknowledgement procedure.
 - Push [EXIT] to return to the normal operating mode.*
 - *The exit confirmation dialog (p. 27) is displayed.

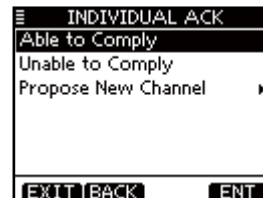

/// When “INDIVIDUAL ACK” is set to “Auto (Unable),” the transceiver automatically replies to the Call. In that case, both the TX and RX calls are stored in the Transmitted and Received Call Logs.

◇ Receiving a Group Call

When a Group Call is received:

- ➔ The alarm sounds for 2 minutes.
- ➔ “RCVD GROUP CALL” appears. The backlight may blink for 2 minutes, depending on the received Category.

- ① Push [ALARM OFF] to stop the alarm and the blinking backlight.
 - Even if you do not push [ALARM OFF], the alarm stops after 2 minutes, and then the screen in step ② is displayed.



- ② Push a softkey to select your desired action.



[IGN]

- ➔ Push to ignore the Call and return to the normal operating mode.
 - The transceiver exits the DSC mode.
 - The “✉” icon continues to blink and the Call is stored in the Received Call Log.

[INFO]

- ➔ Push to display the Received call information. (p. 67)

[PAUSE]

- ➔ Push to pause the countdown.
 - The softkey is displayed if the “CH Auto Switch:” item in the DSC SET menu (p. 71) is set to “10 sec.”
 - Push [RESUME] to resume the countdown.
 - The call is saved in the received call log.

[ACPT]

- ➔ Push to monitor the channel specified by the calling station (Example: 08) for an announcement from the calling station.
 - Push [EXIT] to return to the normal operating mode.*
 - *The exit confirmation dialog (p. 27) is displayed.

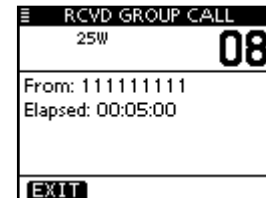

7 DSC OPERATION

◇ Receiving an All Ships Call

When an All Ships Call is received:

- The alarm sounds for 2 minutes.
- “RCVD ALL SHIPS CALL” appears. The backlight may blink for 2 minutes, depending on the received Category.

- ① Push [ALARM OFF] to stop the alarm and the blinking backlight.
 - Even if you do not push [ALARM OFF], the alarm stops after 2 minutes, and then the screen in step ② is displayed.

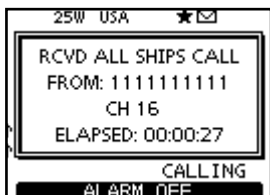

- ② Push a softkey to select your desired action.



[IGN]

- Push to ignore the Call and return to the normal operating mode.
 - The transceiver exits the DSC mode.
 - The “✉” icon continues to blink and the Call is stored in the Received Call Log.

[INFO]

- Push to display the Received call information. (p. 67)

[PAUSE]

- Push to pause the countdown.
 - The softkey is displayed if the “CH Auto Switch:” item in the DSC SET menu (p. 71) is set to “10 sec.”
 - Push [RESUME] to resume the countdown.
 - The call is saved in the received call log.

[ACPT]

- Push to monitor the channel specified by the calling station (Example: 16) for an announcement from the calling station.
 - Push [EXIT] to return to the normal operating mode.*
 - *The exit confirmation dialog (p. 27) is displayed.

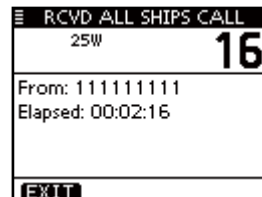

◇ Receiving a Geographical Area Call

When a Geographical Area Call (for the area you are in) is received:

- The alarm sounds for 2 minutes.
- “RCVD GEOGRAPHICAL” appears. The backlight may blink for 2 minutes, depending on the received Category.

- ① Push [ALARM OFF] to stop the alarm and the blinking backlight.
 - Even if you do not push [ALARM OFF], the alarm stops after 2 minutes, and then the screen in step ② is displayed.



- ② Push a softkey to select your desired action.



[IGN]

- Push to ignore the Call and return to the normal operating mode.
 - The transceiver exits the DSC mode.
 - The “✉” icon continues to blink and the Call is stored in the Received Call Log.

[INFO]

- Push to display the Received call information. (p. 67)

[PAUSE]

- Push to pause the countdown.
 - The softkey is displayed if the “CH Auto Switch:” item in the DSC SET menu (p. 71) is set to “10 sec.”
 - Push [RESUME] to resume the countdown.
 - The call is saved in the received call log.

[ACPT]

- Push to monitor the channel specified by the calling station (Example: 08) for an announcement from the calling station.
 - Push [EXIT] to return to the normal operating mode.*
 - *The exit confirmation dialog (p. 27) is displayed.

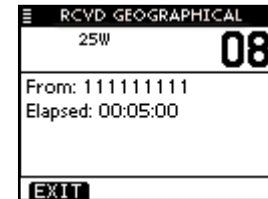

When no GPS receiver is connected or if there is a problem with the connected receiver, all Geographical Area Calls are received, regardless of your position.

7 DSC OPERATION

◇ Receiving a Position Request Call

When a Position Request Call is received:

- The alarm sounds for 2 minutes.
- “RCVD POS REQUEST” appears. The backlight blinks for 2 minutes.

- ① Push [ALARM OFF] to stop the alarm and the blinking backlight.
 - Even if you do not push [ALARM OFF], the alarm stops after 2 minutes, and then the screen in step ② is displayed.



- ② Push a softkey to select your desired action.

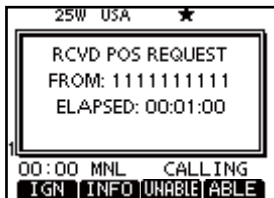

[IGN]

- Push to ignore the Call and return to the normal operating mode.
 - The transceiver exits the DSC mode.
 - The “” icon continues to blink and the Call is stored in the Received Call Log.

[INFO]

- Push to display the Received call information. (p. 67)

[UNABLE]

- When you receive a DSC call, push [UNABLE] to transmit the “Unable to Comply” acknowledgement.
 - The call is saved in the DSC Log.

[ABLE]

- When you receive a DSC call, push [ABLE] to transmit the “Able to Comply” acknowledgement.
 - The call is saved in the DSC Log.

◇ Receiving a Position Report Call

When a Position Report Call is received:

- ➔ The alarm sounds for 2 minutes.
- ➔ “RCVD POSITION REPORT” appears. The backlight blinks for 2 minutes.

- ① Push [ALARM OFF] to stop the alarm and the blinking backlight.
 - Even if you do not push [ALARM OFF], the alarm stops after 2 minutes, and then the screen in step ② is displayed.



- ② Push a softkey to select your desired action.



[EXIT]

- ➔ Push to ignore the Call and return to the normal operating mode.
 - The transceiver exits the DSC mode.
 - The “✉” icon continues to blink and the Call is stored in the Received Call Log.

[INFO]

- ➔ Push to display the Received call information. (p. 67)
 - Push [EXIT] to return to the normal operating mode.*

*The exit confirmation dialog (p. 27) is displayed.



7 DSC OPERATION

◇ Receiving a Polling Request call

When a Polling Request call is received:

- The alarm sounds for 2 minutes.
- “RCVD POLLING REQUEST” appears. The backlight blinks for 2 minutes.

- ① Push [ALARM OFF] to stop the alarm and the blinking backlight.
 - Even if you do not push [ALARM OFF], the alarm stops after 2 minutes, and then the screen in step ② is displayed.

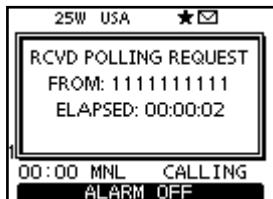

- ② Push a softkey to select your desired action.

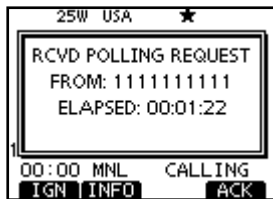

[IGN]

- Push to ignore the Call and return to the normal operating mode.
 - The transceiver exits the DSC mode.
 - The “✉” icon continues to blink and the Call is stored in the Received Call Log.

[INFO]

- Push to display the Received call information. (p. 67)

[ACK]

- Push to display the “POLLING REPLY” screen to reply to the Call. (p. 53)

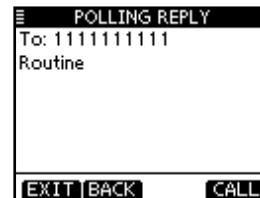

When “POSITION ACK” is set to “Auto,” the transceiver automatically replies to the Call. In that case, both the TX and RX calls are stored in the Transmitted and Received Call Logs.

◇ Receiving a Test Call

When a Test Call is received:

- ➔ The alarm sounds for 2 minutes.
- ➔ “RCVD TEST CALL” appears. The backlight blinks for 2 minutes.

- ① Push [ALARM OFF] to stop the alarm and the blinking backlight.
 - Even if you do not push [ALARM OFF], the alarm stops after 2 minutes, and then the screen in step ② is displayed.



- ② Push a softkey to select your desired action.



[IGN]

- ➔ Push to ignore the Call and return to the normal operating mode.
 - The transceiver exits the DSC mode.
 - The “✉” icon continues to blink and the Call is stored in the Received Call Log.

[INFO]

- ➔ Push to display the Received call information. (p. 67)

[ACK]

- ➔ Push to display the “TEST ACK” screen to reply to the Call. (p. 47)

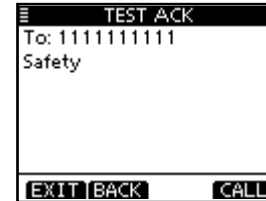

When “TEST ACK” is set to “Auto,” the transceiver automatically replies to the Call. In that case, both the TX and RX calls are stored in the Transmitted and Received Call Logs.

◇ Receiving a Test Acknowledgement Call

When a Test Acknowledgement Call is received:

- The alarm sounds for 2 minutes.
- “Received ACK” is displayed. The backlight blinks for 2 minutes.

① Push [ALARM OFF] to stop the alarm and the blinking backlight.

- Even if you do not push [ALARM OFF], the alarm stops after 2 minutes, and then the screen in step ② is displayed.



② Push [EXIT] to return to the normal operating mode.

- The transceiver exits the DSC mode.
- “” continues to blink and the Call is stored in the Received Call Log.

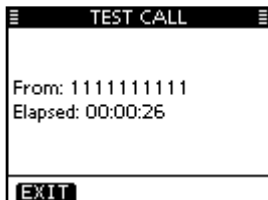

■ Received Call log

The transceiver automatically stores up to 50 distress messages and 50 other messages, and they can be used as a supplement to your logbook.



- While in the normal operating mode, the “” icon blinks in the upper right corner of the LCD when there is an unread DSC message.

◇ Distress message

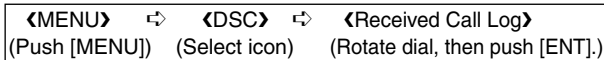
① Push the softkey [LOG] to enter “RCVD CALL LOG” in the DSC CALLS menu, or you can enter it through the Menu screen.



② Push []/[] to select “Distress,” then push [ENT].

- The Distress messages are stored in “Distress.”
- The “” icon appears when there are unread DSC messages.
- The “” icon appears when there are no unread DSC messages.
- No icon appears when there are no DSC messages.
- Push [BACK] to return to the previous screen.
- Push [EXIT] to return to the normal operating mode.

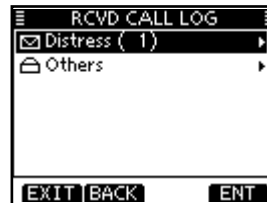

- ③ Rotate dial or push [▲]/[▼] to select the desired item, then push [ENT].



- ④ Rotate dial or push [▲]/[▼] to scroll the DSC message contents.



- ⑤ To delete the displayed DSC message, push [DEL].
 • The confirmation screen is displayed, then push [OK] to delete.
- ⑥ Push [EXIT] to return to the normal operating mode.

◇ Other messages

- ① Push [LOG] to enter “RCVD CALL LOG” in the DSC CALLS menu, or you can enter it through the Menu screen.

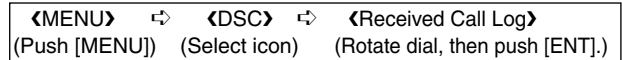

- ② Push [▲]/[▼] to select “Others,” then push [ENT].
- The messages other than the Distress are stored in “Others.”
 - The “✉” icon appears when there are unread DSC messages.
 - The “👛” icon appears when there are no unread DSC messages.
 - No icon appears when there are no DSC messages.
 - Push [BACK] to return to the previous screen.
 - Push [EXIT] to return to the normal operating mode.



☞ Continued on the next page

7 DSC OPERATION

◇ Other messages (Continued)

- ③ Rotate dial or push [▲]/[▼] to select the desired item, then push [ENT].



- ④ Rotate dial or push [▲]/[▼] to scroll the DSC message contents.
- The stored message has various information, depending on the DSC call type.



- ⑤ To delete the displayed DSC message, push [DEL].
- The confirmation screen is displayed, then push [OK] to delete.
- ⑥ Push [EXIT] to return to the normal operating mode.

■ Transmitted Call log

The transceiver automatically stores up to 50 transmitted calls, and the logs can be used as a supplement to your log-book.

- ① Enter “TX CALL LOG” in the DSC CALLS menu.

◀MENU> ⇄ <DSC> ⇄ <Transmitted Call Log>
(Push [MENU]) (Select icon) (Rotate dial, then push [ENT].)

- Push [BACK] to return to the previous screen.
- Push [EXIT] to return to the normal operating mode.

- ② Rotate dial or push [▲]/[▼] to select the desired item, then push [ENT].

- ③ Rotate dial or push [▲]/[▼] to scroll the DSC message contents.

- ④ To delete the displayed DSC message, push [DEL].
- The confirmation screen is displayed, then push [OK] to delete.
- ⑤ Push [EXIT] to return to the normal operating mode.

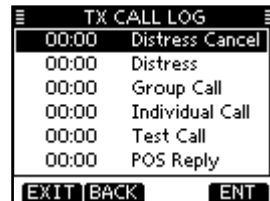

■ DSC Settings

- ◇ Position Input (See page 22)
- ◇ Add Individual ID/Group ID (See pages 19, 20)
- ◇ Delete Individual ID/Group ID (See page 21)

◇ Automatic Acknowledgement

These items set the Automatic Acknowledgement function to “Auto” or “Manual.”

When an Individual, Position Request, Polling Request or Test Call is received, the transceiver automatically transmits an Individual Acknowledgement, Position Reply, Polling Reply or Test Acknowledgement Call, respectively.

When “INDIVIDUAL ACK” is set to “Auto,” the transceiver automatically transmits the Acknowledgment call including “Unable to Comply” (No Reason Given) after receiving the Individual call.

- ① Enter either “INDIVIDUAL ACK,” “POSITION ACK” or “TEST ACK” in the DSC Settings menu.

◀MENU▶ ⇄ ▶DSC SET▶ ⇄ ▶Individual ACK▶ (Push [MENU]) (Select icon) (Rotate dial, then push [ENT].)
--

◀MENU▶ ⇄ ▶DSC SET▶ ⇄ ▶Position ACK▶

◀MENU▶ ⇄ ▶DSC SET▶ ⇄ ▶Test ACK▶

- ② Rotate dial or push [▲]/[▼] to select “Auto” or “Manual” then push [ENT].
 - Push [BACK] to return to the previous screen.

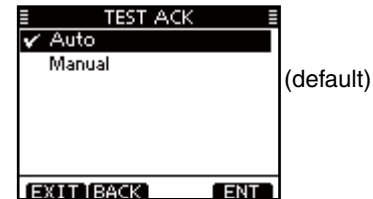
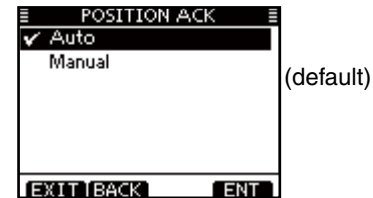
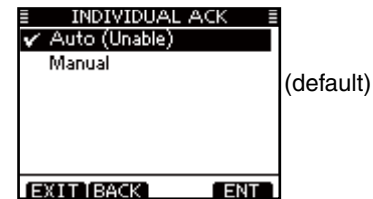

- ③ Push [EXIT] to return to the normal operating mode.

7 DSC OPERATION

◇ Channel Auto Switch function

By regulation, after receiving a DSC call, the transceiver switches the operating channel to the channel assigned by the received DSC call. However, when this setting is set to "OFF," the function enables the transceiver to remain on the operating channel, even after receiving a DSC call.

- ① Enter "CH AUTO SWITCH" in the DSC Settings menu.

◀MENU▶	↔	◀DSC SET▶	↔	◀CH Auto Switch:▶
(Push [MENU])		(Select icon)		(Rotate dial, then push [ENT].)

- ② Rotate dial or push [▲]/[▼] to set the Channel Auto Switch function to "Auto (No Delay)," "10 Second Delay" or "OFF," then push [ENT].

- Push [BACK] to return to the previous screen.

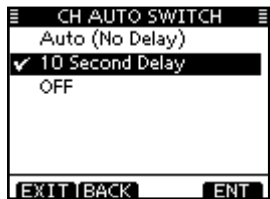

(default)

Auto (No Delay): After receiving a DSC call, and [ACPT] is pushed on the confirmation screen, the transceiver immediately switches to the channel assigned by the received DSC call.

10 Second Delay: After receiving a DSC call, and [ACPT] is pushed on the confirmation screen, the transceiver remains on the current operating channel for 10 seconds. After that, the transceiver automatically switches to the channel assigned by the received DSC call. (default)

OFF : Even after receiving a DSC call, the transceiver remains on the operating channel.

- The "📶" icon appears.

- ③ Push [EXIT] to return to the normal operating mode.

◇ DSC Data Output

Select an option for the DSC Data Output function.
When receiving a DSC call, this function makes the transceiver send the DSC data from its NMEA Output port to a connected device.

- 1 Enter “DSC DATA OUTPUT” in the DSC Settings menu.

◀MENU	↔	◀DSC SET	↔	◀DSC Data Output
(Push [MENU])		(Select icon)		(Rotate dial, then push [ENT].)

- 2 Rotate dial or push [▲]/[▼] to set the DSC Data Output function to “All Station,” “List Station” or “OFF,” and then push [ENT].
 - Push [BACK] to return to the previous screen.

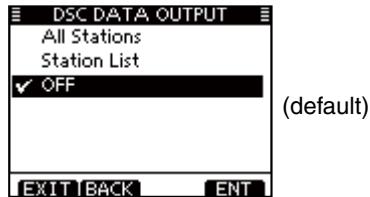

All Stations: Outputs the call from any vessel from the NMEA Output port.

Station List: Outputs the call from any vessels listed on the Individual ID screen.

OFF: Does not output any call to the external equipment.

- 3 Push [EXIT] to return to the normal operating mode.

◇ Alarm Status

Set the Alarm function ON or OFF, depending on the Category or Status.

- 1 Enter “ALARM STATUS” in the DSC Settings menu.

◀MENU	↔	◀DSC SET	↔	◀Alarm Status
(Push [MENU])		(Select icon)		(Rotate dial, then push [ENT].)

- 2 Rotate dial or push [▲]/[▼] to select the status, and then push [ENT].
 - Push [BACK] to return to the previous screen.
 - “Safety,” “Routine,” “Warning,” “Self-Terminate” and “Discrete” are selectable. (default: ON)



- 3 Rotate dial or push [▲]/[▼] to set the Alarm setting to “ON” or “OFF, and then push [ENT].”

- 4 Push [EXIT] to return to the normal operating mode.

7 DSC OPERATION

◇ Channel 70 Squelch level

Set the squelch level on Channel 70.

The transceiver has 11 squelch levels between 1 (loose squelch) and 10 (tight squelch) and OPEN.

OPEN is completely open.

- ① Enter "CH 70 SQL LEVEL" in the DSC Settings menu.

◀MENU▶	↔	◀DSC SET▶	↔	◀CH 70 SQL Level▶
(Push [MENU])		(Select icon)		(Rotate dial, then push [ENT].)

- ② Rotate dial or push [▲]/[▼] to adjust the squelch level until the noise just disappears, then push [ENT].
 - Push [BACK] to cancel and return to the previous screen.

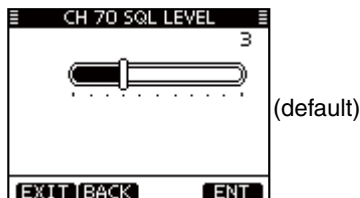

- ③ Push [EXIT] to return to the normal operating mode.

◇ DSC Loop Test

The DSC loop test function sends transmit DSC signals to the receive AF circuit to compare and check the TX and RX signals at the AF level.

- ① Enter "DSC LOOP TEST" in the DSC Settings menu.

◀MENU▶	↔	◀DSC SET▶	↔	◀DSC Loop Test▶
(Push [MENU])		(Select icon)		(Rotate dial, then push [ENT].)

- ② Push [ENT] to start the DSC loop test.
 - Push [BACK] to cancel and return to the previous screen.



- When the transmit DSC and receive DSC signals are matched, "OK" appears.

- ③ Push [EXIT] to return to the normal operating mode.

/// If "NG" appears in step ②, either or both TX and RX DSC circuits has a problem. In that case, you will have to send the transceiver to your nearest dealer for repair.

■ Making an Individual call using an AIS transponder

When the optional MA-500TR CLASS B AIS TRANSPONDER is connected to your transceiver, an individual DSC call can be transmitted to a selected AIS target, without needing to enter the target's MMSI code. In this case, the call type is automatically set to Routine.

See page 102 for connecting instructions.

/// To ensure correct operation of the DSC function, make sure you correctly set the CH70 SQL Level. (p. 73)

Step 1: Transponder's operation

- ① Select a desired AIS target on the plotter, target list or danger list display.
 - You can also go to the next step whenever the detail screen of the AIS target is displayed.
 - Make sure the transceiver is in the normal operating mode. Otherwise, you cannot make an individual DSC call using the transponder.
- ② Push [DSC] to display the voice channel selection screen, and then push [▲]/[▼] to select a desired voice channel.*
 - Voice channels are already preset into the transponder in recommended order.

*When a coast station is selected in step ①, a voice channel will be specified by the coast station, therefore you cannot change the channel. The transponder will display "Voice Channel is specified by the Base station," in this case.



Transponder's display



Transceiver's display

- ③ Push [DSC] to transmit an individual DSC call to the AIS target.
 - If Channel 70 is busy, the transceiver stands by until the channel becomes clear.
 - If the transceiver cannot make the call, the transponder will display "DSC Transmission FAILED."

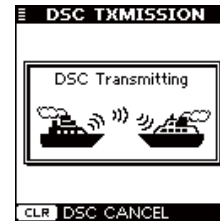

Transponder's display



Transceiver's display

7 DSC OPERATION

■ Making an Individual call using an AIS transponder (Continued)

- ④ After making the individual DSC call, the transponder will display “DSC Transmission COMPLETED.”
- Push [CLEAR] to return to the screen displayed before you entered the voice channel selection screen in step ②.
 - The transceiver stands by on Channel 70 until an acknowledgement is received.

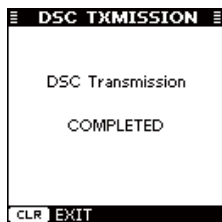

Transponder's display

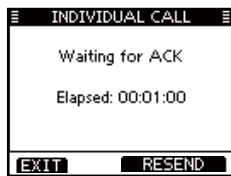

Transceiver's display

Step 2: Transceiver's operation

- ⑤ When the acknowledgement is received, alarm sounds.
- If the acknowledgement 'Able to comply' is received, push [ALARM OFF] to stop the alarm, and then select the intership channel specified in step ②.
 - A different intership channel will be selected if the station you called cannot use the channel.
 - To reply, push [PTT] and speak at a normal voice level.
 - You can check the MMSI code or the name, if programmed, of the AIS target on the display.
 - If the acknowledgement 'Unable to comply' is received, push [ALARM OFF] to stop the alarm, and then “INDIVIDUAL CALL FAILED” is displayed.

'Able to comply' is received

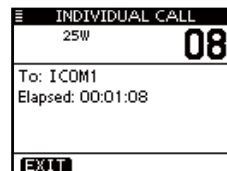

'Unable to comply' is received



- ⑥ After the communication is finished, push [EXIT] to return to the normal operating mode.

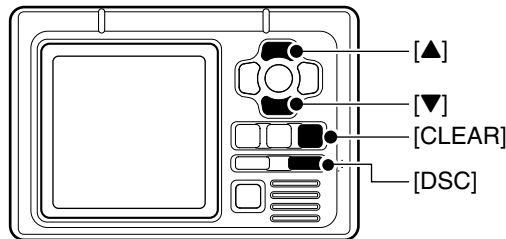

TRANSPONDER

■ Intercom operation

The optional Intercom function allows you to talk between the deck and the cabin. The optional HM-195 COMMANDMICIV™ is required for Intercom operation.

Connect the HM-195 COMMANDMICIV™ as described on page 107.

- Transmitting is disabled while using the intercom.
- The received signal is muted while using the intercom.

- ① Hold down [PWR](Dial) to turn ON the power.
 - The command microphone power is automatically turned ON, even if the power is OFF.
- ② Push [MENU].
- ③ Rotate dial or push [◀]/[▶] to select the “INCM,” icon and then push the softkey below the icon.
 - INTERCOM screen is displayed.
 - Push [BACK] to return to the previous screen.
- ④ Hold down [INCM CALL] to sound the intercom beeps.
 - The transceiver and the command microphone sound beeps while holding down [INCM CALL].
 - “CALL” appears.

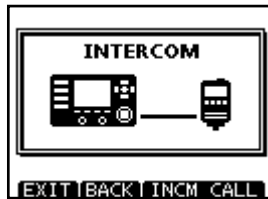

- ⑤ After releasing [INCM CALL], hold down [PTT] and speak into the microphone at a normal voice level.
 - “TALK” appears on the caller’s display, or “LSTN” appears on the listener’s display.
 - To adjust the transceiver’s intercom volume level, rotate volume dial.
 - To adjust the HM-195’s intercom volume level, rotate [VOL/SQL] (Dial) on the HM-195.
- ⑥ After releasing [PTT], you can hear the response through the speaker.



On the caller’s display



On the listener’s display

- ⑦ Push [EXIT] to return to normal operating screen.

While in the Intercom mode, the transmit and receive functions are disabled. When the transceiver is transmitting, the Intercom function is disabled.

8 OTHER FUNCTIONS

■ RX Hailer function

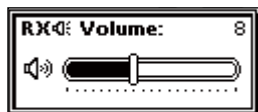

The RX Hailer function enables you to hear the received audio on the deck or bridge through a Hailer speaker. Connect an external hailer speaker as described on page 101.

- ① Push [RX ] to enter the RX Hailer mode.
 - The RX Hailer volume level adjustment screen is displayed.

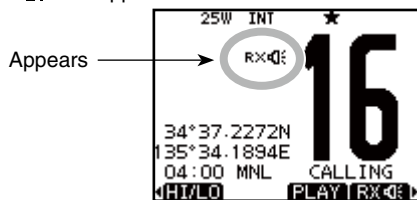

- ② Rotate dial or push [▲]/[▼]/[◀]/[▶] to adjust the RX Hailer volume level, and then push [ENT].
 - The “RX ” icon appears.



- ③ To return to normal operating mode, push [RX ].
 - The “RX ” icon disappears.

▨ To adjust the audio output level in the RX Hailer mode, hold down [RX ] for 1 second to display the RX Hailer volume level adjustment screen, and then rotate dial or push [▲]/[▼]/[◀]/[▶]. After adjusting, push [ENT] to set it.

■ Hailer operation

The IC-M506 has a 2 way hailer function, making it unnecessary to leave the bridge to talk with another party. Connect an external hailer speaker as described on page 101.

- Transmitting is not possible while using the hailer.

- ① Push [MENU].
- ② Rotate dial or push [◀]/[▶] to select the “HAILER” icon and then push the softkey below the icon.
 - HAILER screen is displayed.
- ③ Hold down [PTT] and speak at a normal voice level.
 - While holding down [PTT], the screen below is displayed.
 - To adjust the hailer level, rotate dial.
 - Push [BACK] to return to the previous screen.



- ④ Push [EXIT] to return to normal operating screen.



▨ While in the hailer mode, the transmit and receive functions are disabled. When the transceiver is transmitting, the hailer function is disabled.

■ Horn function

◇ Automatic foghorn function

The automatic foghorn function sounds a horn repeatedly until the function is turned OFF. Four patterns are available for varying conditions.

The foghorn outputs from the hailer speaker. To use this function, the hailer speaker must be connected to the transceiver. See page 101 for connection details.

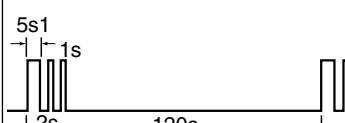
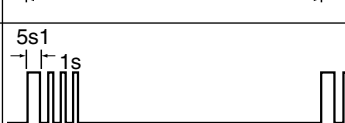
TYPE		PATTERN	USAGE
UNDERWAY	One 5-second blasts every 120 seconds.		Motor vessel underway and making way.
STOP	Two 5-second blasts (separated by 2 seconds) every 120 seconds.		Motor vessel underway but stopped (not making way).
SAIL	One 5-second blast followed by two 1-second blasts (each separated by 2 seconds) every 120 seconds.		Sailing vessel underway, fishing vessel (underway or anchored), vessel not under command, a vessel restricted in her ability to maneuver (underway or at anchor), or a vessel towing or pushing another ahead.
TOW	One 5-second blast followed by three 1-second blasts (each separated by 2-seconds) every 120 seconds.		Vessel under tow (manned).

8 OTHER FUNCTIONS

◇ Automatic foghorn function (Continued)

- ① Enter “Auto Foghorn” in the HORN menu.

◀MENU▶ ⇄ ◀HORN▶ ⇄ ◀Auto Foghorn▶
(Push [MENU]) (Select icon) (Rotate dial, then push [ENT].)

- ② Rotate dial or push [▲]/[▼] to select the desired foghorn pattern, and then push [ENT].
- Push [BACK] to return to the previous screen.
 - Push [EXIT] to return to the normal operating mode.

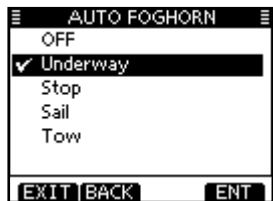

- ③ Rotate dial or push [▲]/[▼]/[◀]/[▶] to adjust the foghorn level.
- The foghorn level is adjustable in 20 steps.



- ④ Push [MENU] to exit the MENU screen.
- The horn icon is displayed.

Appears →

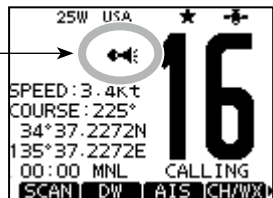

- ⑤ To return to normal operation, select [OFF] in the Auto Foghorn menu.

◇ Manual Horn function

- ① Enter “Manual Horn” in the HORN menu.

◀MENU▶ ⇄ ◀HORN▶ ⇄ ◀Manual Horn▶
(Push [MENU]) (Select icon) (Rotate dial, then push [ENT].)

- ② Hold down [HORN] to sound a horn.
- While holding down [HORN], the horn sounds, and the screen below is displayed.
 - To adjust the horn volume level, rotate dial.
 - Push [BACK] to return to the previous screen.



- ③ Push [EXIT] to return to the normal operating screen.

While in the Horn mode, the transmit and receive functions are disabled. When the transceiver is transmitting, the Horn function is disabled.

■ Voice scrambler operation

(Available when the scrambler unit is installed)

The voice scrambler provides private communications. In order to receive or send scrambled transmissions, you must activate the scrambler function. You also need to program the scrambler code in the Menu screen. (p. 102)

▨ The scrambler function automatically turns OFF when Channel 16 or 70 is selected.

- ① Select an operating channel except Channel 16, 70 or weather channels.
- ② Push [SCBL] to turn the Voice Scrambler ON or OFF.
 - The “SBL” icon appears when the voice scrambler is ON.

◇ Programming scrambler codes

There are 32 codes (1 to 32) available for programming. Set the code in the Menu screen. In order to understand each other, all transceivers in your group must have the same scramble code. See page 98 for scrambler code setting details.

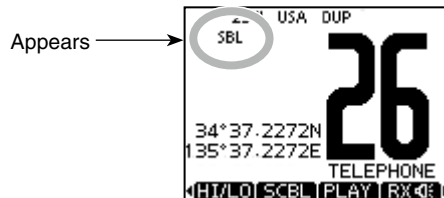

■ Voice recorder function

This transceiver has an automatic recording function that can record the last 120 seconds of the receiving audio. You can playback the audio that you could not hear clearly.

Starts recording automatically when the signal is received.

- The “REC” icon appears while recording.
- Stops recording 3 seconds after the signal disappears.
- Stops recording when the channel is changed.
- The recorded voice data is erased when the transceiver is turned OFF.



◇ Playback the recorded voice

- ① Push [PLAY] to playback the recorded voice.
 - The “▶” icon appears while playing.
- ② Push [STOP] to return to normal operating screen.



■ About AIS

AIS (The automatic identification system) is primarily used for collision-risk management and navigation safety. It automatically transmits and receives vessel information, such as the vessel name, MMSI code, vessel type, position data, speed, course, destination and more. Information is exchanged among the vessels and/or base stations on the VHF maritime mobile band. The information helps to identify other nearby vessels or stations by displaying the received data on a plotter or a radar screen.

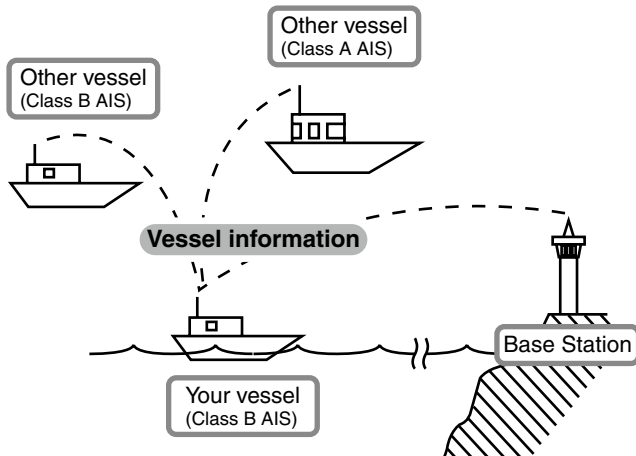

■ AIS Classes

There are seven types of AIS stations; vessels, base stations, Search and Rescue (SAR), Aids to Navigation (AtoN), Search and Rescue Transmitter (AIS-SART), MOB (Man OverBoard) and EPIRB (Emergency Position Indicating Radio Beacon)-AIS.

There are two classes of AIS units, which are installed on vessels; Class A and Class B.

Under the Safety Of Life At Sea (SOLAS) convention, all SOLAS vessels, as described below, are required to install a Class A AIS transponder:

- Upwards of 300 gross tonnage engaged on international voyages.
- Passenger vessels, irrespective of size, engaged on international voyages.
- Upwards of 500 gross tonnage not engaged on international voyages.

A Class B AIS transponder is designed to be interoperability with Class A units, but not to impact the Class A network.

Many commercial vessels, and some leisure craft, not classified as requiring a Class A unit, choose to install a Class B unit to avoid accidents at sea.

■ Function display

There are three types of function display; plotter, target list and danger list, and you can select your desired type using the [DISP] key.

- ① Push [MENU].
- ② Rotate dial or push [◀]/[▶] to select the “AIS” icon and then push the softkey below the icon.
 - AIS plotter is displayed.
- ③ Push [▲]/[▼] to adjust the plotter range.

◇ Plotter screen

After select the “AIS” icon in the menu screen, the plotter screen is displayed. If the GPS is connected and it receives signals from a satellite. It shows the display range and the icons of the AIS targets.

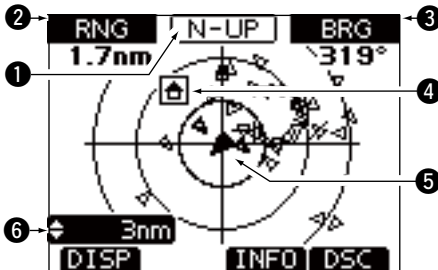

① DISPLAY TYPE

Shows the selected display type. You can select the display type from “AIS SET” in the menu screen (p. 88)

- When “N-UP” is displayed, the top of the plotter screen represents North.
- When “AC-UP” is displayed, the top of the plotter screen represents the direction your course is heading.

② RANGE/CPA INFORMATION

- Shows the range information from your vessel to the selected AIS target.
- Shows the CPA (Closest Point of Approach) information of the selected AIS target whose CPA is within 6 nm (nautical miles) and TCPA (Time to CPA) is within 60 minutes of your vessel.

③ BEARING/TCPA INFORMATION

- Shows the bearing information from your vessel to the selected AIS target.
- Shows TCPA information of the selected AIS target whose CPA is within 6 nm (nautical miles) and TCPA is within 60 minutes of your vessel.

④ TARGET BOX

Shows the selected AIS target.

- When a target box appears, push [ENT] to display the detail screen of the selected AIS target.

9 AIS RECEIVER (Depending on versions)

■ Function display (Continued)



5 YOUR VESSEL ICON

Your vessel icon appears in the center of the screen.

- When "N-UP" is displayed, the vessel icon automatically points in the direction you are heading, in 45 degree steps.
- When "AC-UP" is displayed, the vessel icon constantly points to the top of the plotter screen.
- When your vessel moves less than 2 knots, the "●" icon appears.

6 DISPLAY RANGE

Shows the selected display range.

➡ Push [▲]/[▼] to select display range.

- 0.125, 0.25, 0.5, 0.75, 1.5, 3, 6, 12, 24 nm (nautical miles) are selectable.

• Description of the icons

Icon	Description
	AIS target: Vessel The tip of the target triangle automatically points in the direction it's heading. The icon blinks when the AIS target is closer than your CPA and TCPA settings. (Dangerous target)
	AIS target: Lost target* The target triangle is marked with a diagonal line.
	AIS target: Base Station
	AIS target: Search and Rescue (SAR)
	AIS target: Aids to Navigation (AtoN)
	AIS target: AIS-SART, MOB and EPIRB-AIS

*A vessel is regarded as a "Lost target" after a specified period of time has passed since the vessel last transmitted data.

The "Lost target" icon disappears from the plotter screen 6 minutes and 40 seconds after the vessel was regarded as a "Lost target." Ask your dealer for details.

◇ Target list screen

In the plotter screen, push [DISP] to switch to the target list screen, which shows all AIS targets being detected by the transponder.

The AIS target data is sorted by the distance from your vessel, and the closest target is located on the top of the list.

- Rotate dial or push [▲]/[▼] to select an AIS target.
- Push [INFO] or [ENT] to display the detail screen of the selected AIS target. (p. 83)
- Push [DSC] to transmit DSC call to selected AIS target.

MMSI/Name	RNG	BRG
SUNFLOWER S	0.5	099
311864	0.5	063
MIYAZAKI EX	0.6	098
431000	0.7	069
SUNFLOWER C	0.9	023

① THE NUMBER OF TARGETS

Shows the number of AIS targets which are being detected by the transceiver.

② TARGET INFORMATION

Shows the following AIS target information:

- MMSI code or name, if the name is programmed.
- Range (RNG) from your vessel to the target (unit: nautical mile)
- Bearing (BRG) from your vessel to the target (unit: degree)

◇ Danger list screen

In the target list display, push [DISP] to switch to the danger list screen, which helps you to find any dangerous target whose CPA is within 6 nm (nautical miles) and TCPA is within 60 minutes of your vessel.

- Rotate dial or push [▲]/[▼] to select an AIS target.
- Push [◀]/[▶] to change the sort of AIS target data, sort by CPA or TCPA.
- Push [INFO] or [ENT] to display the detail screen of the selected AIS target. (p. 83)
- Push [DSC] to transmit DSC call to selected AIS target.

MMSI/Name	CPA	TCPA
OBELIX	0.0	27.9
SHIRYUMARU	0.4	39.3
KOUSSHO MA	0.6	5.7
431401	0.8	12.0
312799	0.9	17.1

① THE NUMBER OF DANGEROUS TARGETS

Shows the number of AIS targets which are being detected by the transceiver.

② DANGER TARGET INFORMATION

Shows the following dangerous target information:

- MMSI code or name, if the name is programmed.
- CPA: Closest Point of Approach (unit: nautical mile)
- TCPA: Time to CPA (unit: minute)

9 AIS RECEIVER (Depending on versions)

■ About the detail screen

The detail screen displays the information about the selected AIS target. The contents differ, depending on the AIS class.

- Push [▲]/[▼] to select an AIS target in the target list screen, danger list screen, or plotter screen and then push [INFO] or [ENT].
 - The detail screen is displayed.
- Rotate dial or push [▲]/[▼]/[◀]/[▶] to scroll the page.
- Push [EXIT] to return to the normal operating mode.
 - Push [BACK] to return to the previous screen.

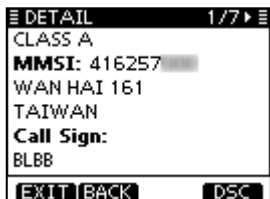

Example of detail screen

◇ Content lists of Class A vessels' DETAIL screens

- AIS Class
- MMSI Code
- Ship Name
- Country Name
- Call Sign
- IMO Number
- CPA (Closest Point of Approach)
- TCPA (Time to CPA)
- Position (Latitude, Longitude)
- Speed Over Ground
- Course Over Ground
- Heading
- Position Accuracy (H: High, L: Low)
- Range
- Bearing
- Rate Of Turn
- Bow to Antenna length
- Stern to Antenna length
- Port side to Antenna length
- Starboard side to Antenna length
- Length
- Beam
- Draught
- Type of Ship
- Navigation Status
- Destination
- Date
- Time

◇ Content lists of Class B vessels' DETAIL screens

- AIS Class
- MMSI Code
- Ship Name
- Country Name
- Call Sign
- Vendor ID
- CPA (Closest Point of Approach)
- TCPA (Time to CPA)
- Position (Latitude, Longitude)
- Speed Over Ground
- Course Over Ground
- Heading
- Position Accuracy (H: High, L: Low)
- Range
- Bearing
- Bow to Antenna length
- Stern to Antenna length
- Port side to Antenna length
- Starboard side to Antenna length
- Length
- Beam
- Type of Ship

◇ Content lists of Base Station targets' DETAIL screens

- AIS Class
- MMSI Code
- Position (Latitude, Longitude)
- Position Accuracy (H: High, L: Low)
- Range
- Bearing

◇ Content lists of SAR targets' DETAIL screens

- AIS Class
- MMSI Code
- Position (Latitude, Longitude)
- Speed Over Ground
- Course Over Ground
- Position Accuracy (H: High, L: Low)
- Range
- Bearing
- Altitude

◇ Content lists of AtoN targets' DETAIL screens

- AIS Class (AtoN existence (REAL, VIRTUAL))
- MMSI Code
- Target Name
- CPA (Closest Point of Approach)
- TCPA (Time to CPA)
- Position (Latitude, Longitude)
- Position Accuracy (H: High, L: Low)
- Range
- Bearing
- Bow to Antenna length
- Stern to Antenna length
- Port side to Antenna length
- Starboard side to Antenna length
- Length
- Beam
- Position Indicator (ON POS : ON Position, OFF POS : OFF Position)
- Type of AtoN

◇ Content lists of AIS-SART targets' DETAIL screens

- Type of AIS Target
- MMSI Code
- Call Sign
- IMO Number
- Closest Point of Approach
- TCPA (Time to CPA)
- Position (Latitude, Longitude)
- Speed Over Ground
- Course Over Ground
- Heading
- Position Accuracy (H: High, L: Low)
- Range
- Bearing
- Rate Of Turn
- Bow to Antenna length
- Stern to Antenna length
- Port side to Antenna length
- Starboard side to Antenna length
- Length
- Beam
- Draught
- Type of Ship
- Navigation Status
- Destination
- Date
- Time

9 AIS RECEIVER (Depending on versions)

◇ Content lists of MOB targets' DETAIL screens

- Type of AIS Target
- MMSI Code
- Call Sign
- IMO Number
- Closest Point of Approach
- TCPA (Time to CPA)
- Position (Latitude, Longitude)
- Speed Over Ground
- Course Over Ground
- Heading
- Position Accuracy
(H: High, L: Low)
- Range
- Bearing
- Rate Of Turn
- Bow to Antenna length
- Stern to Antenna length
- Port side to Antenna length
- Starboard side to Antenna length
- Length
- Beam
- Draught
- Type of Ship
- Navigation Status
- Destination
- Date
- Time

◇ Content lists of EPIRB-AIS targets' DETAIL screens

- Type of AIS Target
- MMSI Code
- Call Sign
- IMO Number
- Closest Point of Approach
- TCPA (Time to CPA)
- Position (Latitude, Longitude)
- Speed Over Ground
- Course Over Ground
- Heading
- Position Accuracy
(H: High, L: Low)
- Range
- Bearing
- Rate Of Turn
- Bow to Antenna length
- Stern to Antenna length
- Port side to Antenna length
- Starboard side to Antenna length
- Length
- Beam
- Draught
- Type of Ship
- Navigation Status
- Destination
- Date
- Time

◇ AIS combo screen

You can display the AIS plotter during basic operation. (p 9)

- ➔ Push [AIS] to display the AIS plotter on the left side of the screen.
- ➔ Rotate dial or push [▲](CH)/[▼](CH) to select an operating channel.
- ➔ Push [◀]/[▶] to select a vessel.
 - A softkey [INFO] will appear.
- ➔ Push [INFO] or [ENT] to display the detail screen of the selected AIS target.
- ➔ Push [MENU] to enter the Menu screen. (p. 91)
- ➔ Push [CLEAR] to exit the AIS combo screen.



■ AIS Settings

AIS settings can be customized from “AIS SET” on the menu screen.

- ① Push [MENU].
- ② Rotate dial or push [◀]/[▶] to select the “AIS SET” icon and then push the softkey below the icon.
 - AIS settings menu is displayed.

◇ North up/COG UP:

Select the display type for AIS plotter.

- When “North up” is displayed, the top of the plotter display represents North.
- When “COG up” is displayed, the top of the plotter display represents the direction your course is heading.
- Push [BACK] to return to the previous screen.
- Push [EXIT] to return to the normal operating mode.

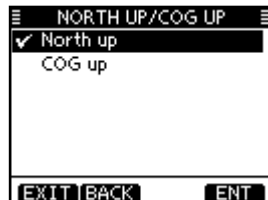

◇ CPA/TCPA

In this menu, you can edit alarm settings for AIS receiver.

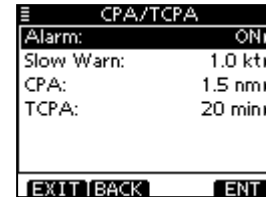

• Alarm

You can turn the collision alarm function ON or OFF.



9 AIS RECEIVER (Depending on versions)

◇ CPA/TCPA (Continued)

• Slow Warn

The GPS receiver calculated COG data of a vessel that is at anchor or drifting is unreliable, and therefore the CPA and TCPA data may not be calculated correctly. If a vessel is anchored in your alarm zone, the unreliable data can cause the collision alarm to sound many times, even if there is no real danger. To prevent this, when the anchored vessel's SOG is less than this set value, the Slow Warn function assumes that vessel's COG is fixed towards your vessel and an alarm will sound.

- ① Rotate dial or push [▲]/[▼] to input the value between 0.1 and 4.9 kt (in 0.1 kt steps), or select OFF. (default: 1.0 kt)
- ② Push [ENT] to save and return to the Menu mode.



NOTE: If other vessels at anchor or drifting come into your alarm zone, the Slow Warn alarm will sound again. Only if the previous vessel disappears from the Danger List (p. 84), and then re-enters the list, can a new Slow Warn or regular alarm sound, depending on the vessels SOG, or CPA and TCPA. The Slow Warn function operates in the same way if your vessel is at anchor and other vessels enter your alarm zone area.

• CPA, TCPA

Enter CPA (Closest Point of Approach) and TCPA (Time to CPA) values.

These settings help you find a dangerous target to avoid a collision. The icon blinks on the plotter display and/or the alarm buzzer sounds, when the AIS target is closer than your CPA and TCPA settings.

- ① Rotate dial or push [▲]/[▼] to select either "CPA" or "TCPA."
 - CPA or TCPA setting menu is displayed.
- ② Rotate dial or push [▲]/[▼] to input the value into that item.
 - CPA: Between 0.1 and 6.0 nm (in 0.1 nm steps) (default: 1.5 nm)
 - TCPA: Between 1 and 60 minutes (in 1 minute steps) (default: 20 min)
- ③ Repeat steps ① and ② to input the value into the other item.
- ④ Push [ENT] or dial to save and return to the Menu mode.

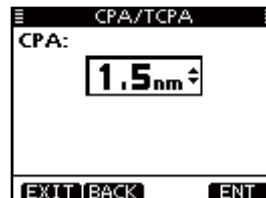

When the CPA setting menu is selected.

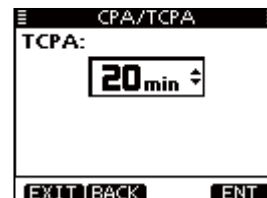

When the TCPA setting menu is selected.

◇ ID BLOCKING

The transceiver blocks AIS transponders that are entered into the ID blocking list. Enter your vessel's transponder ID or other vessel's transponder IDs if necessary to prevent the transceiver from detecting them as dangerous targets.

You can enter maximum of 10 transponder IDs.

• Entering an ID

- Enter the "ID BLOCKING" in the AIS SETTINGS menu.

- The blocked AIS transponder's ID is displayed.
- "No ID" is displayed if there are no blocked AIS transponder.

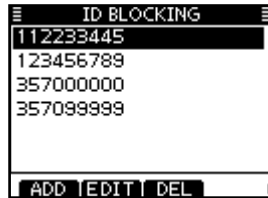

- Push [ADD] to start the ID entry.

- Select a desired number using [▲]/[▼]/[◀]/[▶].
- Push [ENT] or Dial to set it.
- To move the cursor, rotate Dial or select either arrow, "←" or "→," and then push [ENT] or Dial.



- Push [EXIT] to return to the normal operating mode.
 - Push [BACK] or [CLEAR] to return to the previous screen.
- Select [FINISH], and then push [ENT] or Dial to enter it.
- Returns to the "ID BLOCKING" menu.

• Editing an ID

- Enter the "ID BLOCKING" menu.
- Rotate Dial or push [▲]/[▼] to select a desired ID, and then push [EDIT].
 - Select a desired number using [▲]/[▼]/[◀]/[▶].
 - Push [ENT] or Dial to set it.
 - To move the cursor, rotate Dial or select either arrow, "←" or "→," and then push [ENT] or Dial.
 - Push [CLEAR] to cancel and return to the previous screen.
- Select [FINISH], and then push [ENT] or Dial to set it.
 - Returns to the "ID BLOCKING" menu.

• Deleting an ID

- Enter the "ID BLOCKING" menu.
- Rotate Dial or push [▲]/[▼] to select a desired ID, and then push [DEL].
 - "ARE YOU SURE?" is displayed.
- Push [OK] to delete the ID and returns to the "ID BLOCKING" menu.
 - Push [CANCEL] to cancel it.

10 NMEA 2000 CONNECTION (Depending on versions)

■ Description

NMEA 2000 is a communication standard used to connect various marine devices and display units in the vessel.

The IC-M506 can easily connect to a NMEA 2000 network with its plug-and-play functionality, and display the information provided from the devices on the network.

◇ NMEA 2000 settings

Select the sensors in NMEA 2000 network which sends data to the transceiver.

- ① Enter "NMEA 2000 SETTINGS" menu in the menu screen.

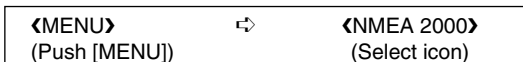

- ② Select the type of data from the menu screen and push [ENT].

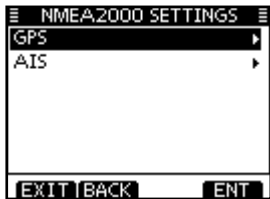

- ③ The transceiver starts searching the devices connected to NMEA 2000 network.



- ④ The list of connected device is displayed.
- ⑤ Select the device to send the data to transceiver and push [ENT].
 - Push [INFO] to display the detail of device.
 - If the transceiver is connected to both NMEA 0183 and NMEA 2000 devices, the NMEA 2000 device has priority. Select "Not Used" if you want to use NMEA 0183 devices.
 - Push [BACK] to return to the previous screen.



- ⑥ Push [EXIT] to exit the MENU screen.

◇ **Compatible PGN list**

Receive		Transmit	
059392	ISO Acknowledgement	059392	ISO Acknowledgement
059904	ISO Request	059904	ISO Request
060928	ISO Address Claim	060928	ISO Address Claim
		126464	PGN List
126996	Product Information	126996	Product Information
129026	COG (course over ground) and SOG (speed over ground) - Rapid Update	129026	COG (course over ground) and SOG (speed over ground) - Rapid Update
129029	GNSS (Global Navigation Satellite System) Position Data	129029	GNSS (Global Navigation Satellite System) Position Data
		129799	Radio Frequency/Mode/Power
		129808	DSC Call Information
129038	AIS Class A Position Report	129038	AIS Class A Position Report
129039	AIS Class B Position Report	129039	AIS Class B Position Report
129040	AIS Class B Extended Position Report	129040	AIS Class B Extended Position Report
129041	AIS Aids to Navigation (AtoN) Report	129041	AIS Aids to Navigation (AtoN) Report
129793	AIS UTC and Date Report (Base Station)	129793	AIS UTC and Date Report (Base Station)
129794	AIS Class A Static and Voyage Related Data	129794	AIS Class A Static and Voyage Related Data
129798	AIS SAR Aircraft Position Report	129798	AIS SAR Aircraft Position Report
129809	AIS Class B "CS" Static Data Report, Part A	129809	AIS Class B "CS" Static Data Report, Part A
129810	AIS Class B "CS" Static Data Report, Part B	129810	AIS Class B "CS" Static Data Report, Part B

11 MENU SCREEN OPERATION

Menu screen operation

The Menu screen is used for programming infrequently changed values, function settings or sending DSC calls.



Menu icons

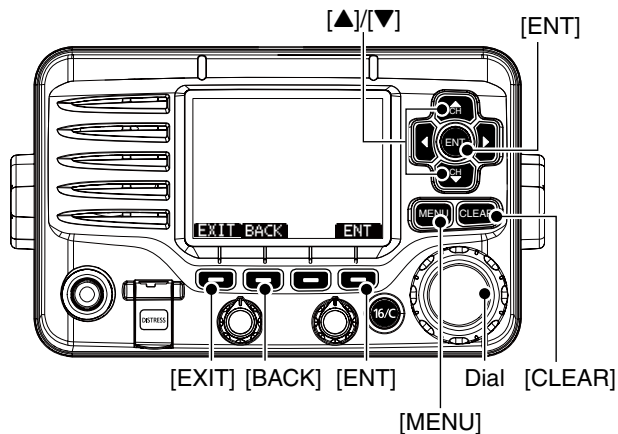

◇ Entering the Menu screen and operation

Example: Set the channel group to "INT".

① Push [MENU].

② Rotate dial or push [◀]/[▶] to select the "RADIO SET" icon and then push the softkey below the icon.

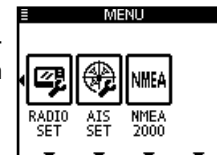

③ Rotate dial or push [▲]/[▼] to select "CHAN Group," and then push [ENT].



④ Rotate dial or push [▲]/[▼] to select "INT" and then push [ENT].
• "✓" is displayed next to "INT".



⑤ Push [EXIT] to exit the Menu screen.
• Push [CLEAR] or [BACK] to return to the previous screen.

■ Menu screen items

The Menu screen contains the following items.

◇ DSC

Item	Ref.	Item	Ref.
• Individual Call	p. 30	• Position Request	p. 39
• Individual ACK*1	p. 33	• Position Reply*1	p. 49
• Group Call	p. 35	• Position Report	p. 41
• All Ships Call	p. 37	• Polling Request	p. 43
• Distress Call	p. 23	• Polling Reply*1	p. 53
• Distress Relay ACK	p. 28	• Test Call	p. 45
• Received Call Log	p. 67	• Test ACK*1	p. 47
• Transmitted Call Log	p. 69		

◇ CONFIG (Configuration)

Item	Ref.	Item	Ref.
• Backlight	p. 95	• Horn Frequency	p. 97
• Display Contrast	p. 95	• Inactivity Timer	p. 97
• Key Beep	p. 95	• Unit ID	p. 99
• Key Assignment	p. 96	• COMMANDMIC SP*3	p. 99
• Key Movement	p. 96		
• UTC Offset	p. 97		

*1 Appears only after receiving a corresponding call.

*2 Appears only when no GPS information is received.

*3 Appears only when the optional HM-195 is connected.

*4 Appears only when a GPS receiver compatible with NMEA 0183 (ver. 2.0 or later) or NMEA 2000 is connected.

*5 Appears only when the voice scrambler unit is installed.

◇ MMSI/GPS

The transceiver shows the programmed MMSI code, GPS information*4, and installed option unit.

If the code is not programmed, “NO DSC MMSI” is displayed.



◇ DSC SET

Item	Ref.	Item	Ref.
• Position Input*2	p. 22	• CH Auto Switch	p. 71
• Individual ID	p. 19	• DSC Data Output	p. 72
• Group ID	p. 20	• Alarm Status	p. 72
• Individual ACK	p. 70	• CH 70 SQL Level	p. 73
• Position ACK	p. 70	• DSC Loop Test	p. 73
• Test ACK	p. 70		

◇ RADIO SET

Item	Ref.	Item	Ref.
• Scan Type	p. 100	• Voice Scrambler*5	p. 102
• Scan Timer	p. 100	• Noise Cancel	p. 102
• Dual/Tri-Watch	p. 101	• Voice Record	p. 103
• CHAN Group	p. 101	• FAV on MIC:	p. 104
• CALL CHAN	p. 101	• RT Indicator:	p. 104
• WX Alert	p. 101		

11 MENU SCREEN OPERATION

■ Configuration items

◇ Backlight

The function display and keys can be backlit for better visibility under low light conditions.

The backlight is adjustable in 7 levels or OFF. (Default: 7)



◇ Display contrast

This item adjusts the contrast of the LCD in 8 steps.

Level 1 is the lowest contrast, and level 8 is the highest contrast. (Default: 5)



◇ Key Beep

You can turn OFF beep tones for silent operation, or can turn ON the tones to have confirmation beeps sound when a key is pushed. (Default: ON)

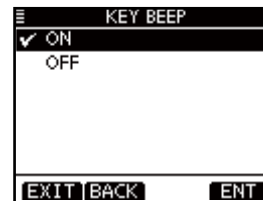

◇ **Key Assignment**

Desired functions can be assigned to softkeys. The assigned function can be used when its key icon is displayed. See page 3 for details of the assignable key functions.

- ① Rotate dial or push [▲]/[▼] to select the desired position, and then push [ENT].
 - To return to the default, select “Set default” and push [ENT].
- ② Rotate dial or push [▲]/[▼] to select the option, and then push [ENT] to set it.
 - “✓” is displayed next to the selected option.

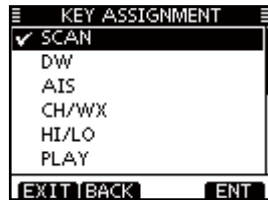

- ③ Push [EXIT] to exit the Menu screen.
 - Push [BACK] to return to the previous screen.

◇ **Key Movement**

Set the movement of softkey icons and menu icons. You can select from 2 types of key movement, “Single” or “Group”. (Default: Group (p. 7))



• **Single key movement**

Single icon moves by pushing [◀]/[▶] once.

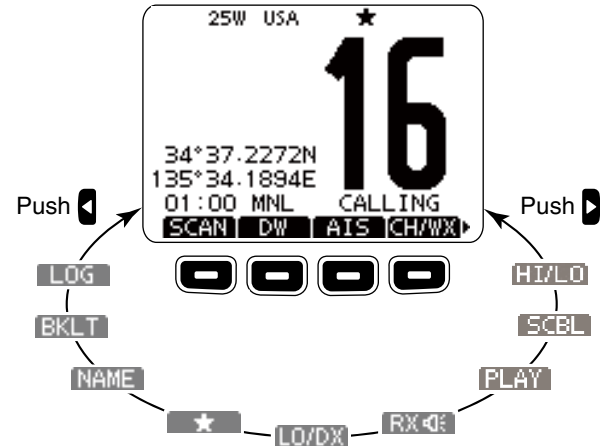

11 MENU SCREEN OPERATION

◇ UTC Offset

Set the offset time between the UTC (Universal Time Coordinated) and your local time to between -14:00 and +14:00 (in 1 minute steps). (Default: 00:00)



◇ Horn Frequency

Set audio frequency of the foghorn.

- Available frequency range is 200 Hz to 700Hz in 50 Hz steps. (Default: 400Hz)

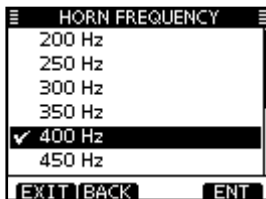

◇ Inactivity Timer

Set the inactivity timer to between 1 and 10 minutes (in 1 minute steps) or OFF for the “Not DSC Related” and “DSC Related” item, and set to between 1 and 15 minutes (in 1 minute steps) or OFF for the “DSC Related” item. The count down alarm sounds 10 seconds before the Inactivity timer returns the current screen to the normal operating screen.

- ① When the “INACTIVITY TIMER” screen is displayed, rotate dial or push [▲]/[▼] to select “Not DSC Related” or “DSC Related,” and then push [ENT].
- ② Rotate dial or push [▲]/[▼] to select the option, and then push [ENT] to set it.
 - “✓” is displayed next to the selected option.
- ③ Push [EXIT] to exit the Menu screen.
 - Push [BACK] to return to the previous screen.

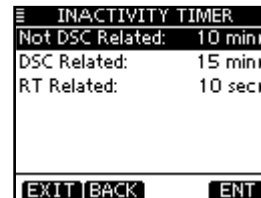

• Not DSC Related

When the LCD displays a screen other than the normal operation screen, or one not related to the DSC, and no key operation occurs for this set period, the transceiver automatically returns to the normal operating screen. (Default: 10 min)



• DSC Related

When the LCD displays the screen related to the DSC, and no key operation occurs for this set period, the transceiver automatically returns to the normal operating screen. (Default: 15 min)



• RT Related

While receiving or transmitting a signal, and when the channel is changed, the RT (Radio Telephone) icon is displayed. The icon disappears if you push no key for the period of time set in the Menu screen shown below. (Default: 30 sec)



11 MENU SCREEN OPERATION

◇ Unit ID

Set a Unit ID number to between 1 and 69. The Unit ID is included in the sentence of the Icom original NMEA format.

(Default: 16)

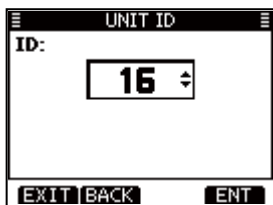

◇ COMMANDMIC Speaker

(Displayed only when the optional HM-195 is connected.)

The HM-195's external speaker can be used instead of the internal speaker. (Default: Internal Speaker)

- The "COMMANDMIC SP" screen is displayed on the HM-195's display. Not displayed on the transceiver's display.

Internal Speaker: Turns ON the internal speaker.

External Speaker: Turns ON the external speaker.



/// Regardless of this setting, the supplied microphone's speaker is ON.

■ Radio Settings items

◇ Scan Type

The transceiver has two scan types to locate signals; Normal scan and Priority scan. A Normal scan searches all Favorite channels in the selected channel group. A Priority scan sequentially searches all Favorite channels, while monitoring Channel 16.
(Default: Normal Scan)

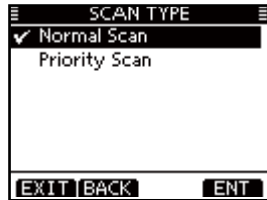

◇ Scan Timer

The scan resume timer can be selected as a pause (OFF) or timer scan (ON). When OFF is selected, the scan pauses until the signal disappears.
(Default: OFF)

- **Priority scan** When ON is selected, the scan pauses for 5 seconds and then resumes, even if a signal has been received on any channel other than Channel 16.
- **Normal scan** When ON is selected, the scan pauses for 5 seconds and then resumes, even if a signal has been received on any channel.

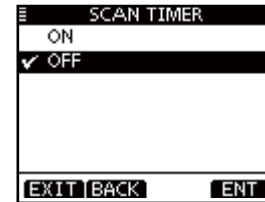

11 MENU SCREEN OPERATION

◇ Dual/Tri-watch

This item can be selected as Dualwatch or Tri-watch. (p. 18)
(Default: Dualwatch)

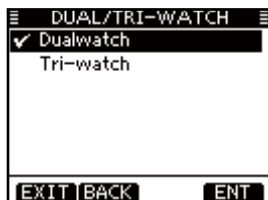

◇ Channel Group

Select a channel group suitable for your operating area. See page 10 for details.
(Default: USA)



◇ CALL CHAN (Call channel)

You can program the Call channel with your most often-used channel in each channel group for quick recall. (p.13)

◇ WX alert (Weather alert)

A NOAA broadcast station transmits a weather alert tone before important weather information.

The "WX" icon with a lightning bolt and cloud symbol blinks until the transceiver is operated after the transceiver detects the alert.

- The "WX" icon with a lightning bolt and cloud symbol appears instead of "WX" when the function is set ON.

(Default: OFF)

ON with Scan: The preprogrammed weather channels are sequentially checked while scanning.

ON: The previously selected (last used) weather channel is checked while scanning.

OFF: The transceiver does not detect a weather alert tone.

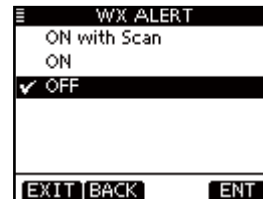

◇ Voice Scrambler

(Available when the scrambler unit is installed)

You can program the scrambler code for voice scrambling. (p. 80) There are 32 codes (1 to 32) available for programming. In order to understand each other, all transceivers in your group must have the same scramble code, as well as the same scrambler unit.



◇ Noise Cancel

Set the Noise Cancel function for both receive and transmit.

RX: The function reduces noise component in your receive signals for your smooth reception.

TX: It is effective to turn ON the TX noise cancel function when you operate under a noisy surround area.

- ① When the "NOISE CANCEL" screen is displayed, rotate dial or push [▲]/[▼] to select "RX" or "TX," and then push [ENT].

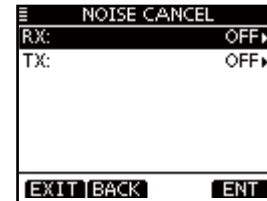

- ② Rotate dial or push [▲]/[▼] to select the option, and then push [ENT] to set it.
 - "✓" is displayed next to the selected option.
- ③ Push [EXIT] to exit the Menu screen.
 - Push [BACK] to return to the previous screen.

11 MENU SCREEN OPERATION

• RX

Turn the receive Noise Cancel function ON or OFF.
(Default: OFF)

OFF: Turns OFF the function.

- 1: The Noise Cancel function reduces noise components in the received signal to approximately one half.
- 2: The Noise Cancel function reduces noise components in the received signal to approximately one third.
- 3: The Noise Cancel function reduces noise components in the received signal to approximately one tenth.

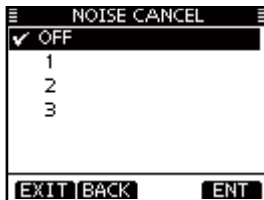

• TX

Turn the transmit Noise Cancel function ON or OFF.
(Default: OFF)

OFF: Turns OFF the function.

ON: The Noise Cancel function reduces noise components in the transmitted signal to one third.

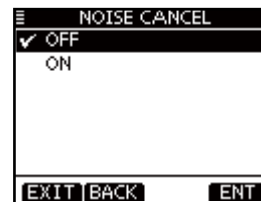

◇ Voice Record

You can disable the voice recorder (p. 80) by select OFF.
(Default: Auto (Last 120 sec))



◇ FAV on MIC

You can select only favorite channels (p. 17) with the supplied microphone. (Default: ON)

ON: Select only favorite channels.

OFF: Select all channels.



◇ RT Indicator

Select whether or not to display RT (Radio Telephone) icon (p. 5) while receiving or transmitting a signal, and when the channel is changed. (Default: ON)

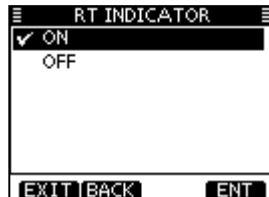

12 CONNECTIONS AND MAINTENANCE

■ Connections

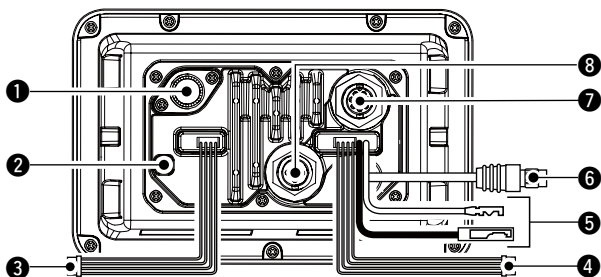

1 ANTENNA CONNECTOR

Connects to a marine VHF antenna with a PL-259 connector.

/// **CAUTION: DO NOT** transmit without an antenna.

2 GROUND TERMINAL

Connects to a vessel ground to prevent electrical shocks and interference from other equipment occurring. Use a self tapping screw (3 × 6 mm: not supplied).

3 NMEA 0183 IN/OUT LEADS

Brown: Talker B (Data-L), Data Out (-)

White: Talker A (Data-H), Data Out (+)

Connect to NMEA input lines of navigation equipment, to receive position data of other ships.

• A NMEA 0183 (ver. 2.0 or later) sentence format DSC or DSE compatible navigation equipment is required.

Green: Listener B (Data-L), GPS In (-)

Yellow: Listener A (Data-H), GPS In (+)

Connect to NMEA output lines of a GPS receiver for position data.

• A NMEA 0183 ver. 2.0 or later RMC, GGA, GNS, GLL and VTG sentence format compatible GPS receiver is required. Ask your dealer about suitable GPS receivers.

4 AF OUT LEADS

Blue: External Speaker (+)

Black: External Speaker (-)

Connect to an external speaker.

Orange: Hailer (+)

Gray: Hailer (-)

Connect to a Hailer.

• Hailer output power: More than 25 W with a 4 Ω load

DO NOT connect the black or grey leads to the ground.

/// These leads must be connected to the External speaker (-) or Hailer (-) lines.

NOTE for NMEA In/Out and AF Out leads:

The connectors are attached to keep the leads together.

Before connecting to a piece of equipment, you should cut the leads to remove the connector.

5 DC POWER CONNECTOR

Connects to a 13.8 V DC power source.

CAUTION: After connecting the DC power cable, NMEA leads, external speaker leads and Hailer leads, cover the connector and leads with an adhesive tape, as shown below, to prevent water seeping into the connection.

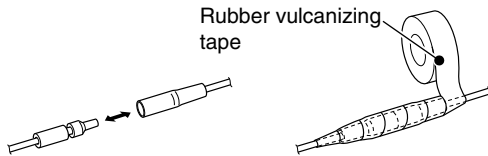

6 MICROPHONE CONNECTOR*

Connects the supplied or optional HM-205* microphone.

- If the connection cable is used to operate at a farther distance, see page 107 for connection.

*The microphone and mic connector vary, depending on the transceiver versions.

7 COMMAND MICROPHONE JACK

Connects to the optional Command microphone. (p. 111)

8 NMEA 2000 CONNECTOR

Connects to the NMEA 2000 network.*

*Some versions of IC-M506 do not have a NMEA 2000 connector.

◇ **Connect to the MA-500TR**

Connect the transceiver to the high-density D-Sub 15-pin connector of the MA-500TR using the OPC-2014* cable. After connecting, an Individual DSC call can be made to the AIS target using the transponder without entering the target's MMSI code.

* The OPC-2014 is supplied with the MA-500TR

- **Listener A (Data-H) lead (Yellow):**
Connects to lead 3 of the OPC-2014.
- **Listener B (Data-L) lead (Green):**
Connects to lead 2 of the OPC-2014.
- **Talker A (Data-H) lead (White):**
Connects to lead 5 of the OPC-2014.
- **Talker B (Data-L) lead (Brown):**
Connects to lead 4 of the OPC-2014.

12 CONNECTIONS AND MAINTENANCE

■ Antenna

A key element in the performance of any communication system is the antenna. Ask your dealer about antennas and the best place to mount them.

■ Fuse replacement

One fuse is installed in the supplied DC power cable. If the fuse blows or the transceiver stops functioning, track down the source of the problem, repair it, and replace the damaged fuse with a new one of the proper rating.

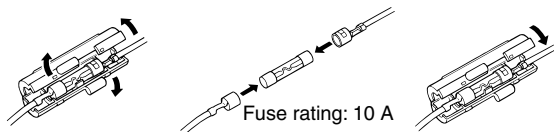

■ Cleaning

If the transceiver becomes dusty or dirty, wipe it clean with a soft, dry cloth.



DO NOT use harsh solvents such as benzine or alcohol, as they will damage transceiver surfaces.

■ Supplied accessories

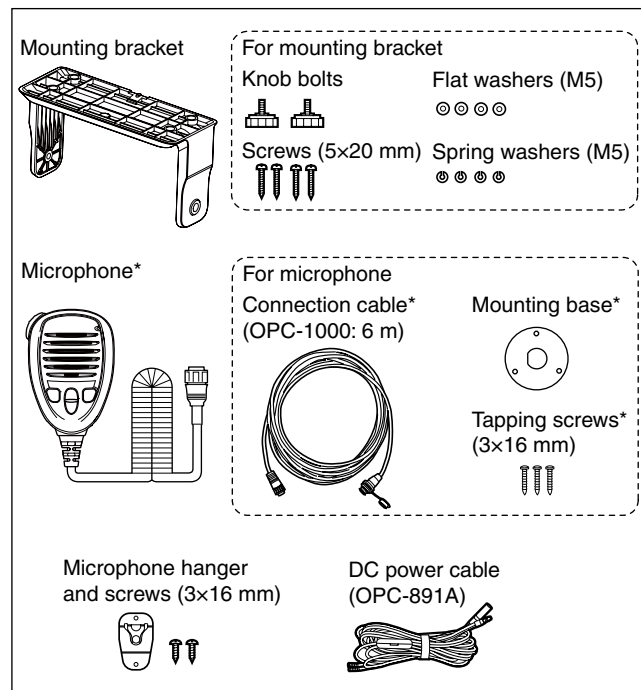

*Not supplied or type is different, depending on the transceiver's versions.

■ Mounting the transceiver

◇ Using the supplied mounting bracket

The universal mounting bracket supplied with your transceiver allows overhead or dashboard mounting.

- ① Mount the bracket securely to a surface which is more than 10 mm thick and can support more than 5 kg using the 2 supplied screws (5 × 20 mm).
- ② Attach the transceiver to the bracket so that the face of the transceiver is at 90° to your line of sight when operating it.

/// **KEEP** the transceiver and microphone at least 1 meter away from the vessel's magnetic navigation compass.

/// **NOTE:** Check the installation angle; the function display may not be easy-to-read at some angles.

• OVERHEAD MOUNTING

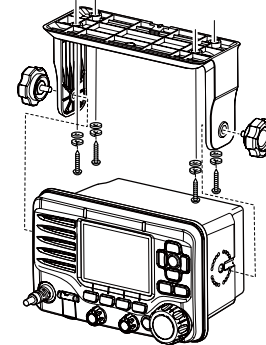

• MOUNTING ON THE BOARD

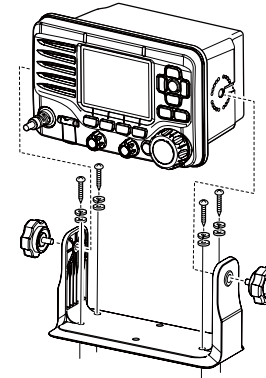

12 CONNECTIONS AND MAINTENANCE

■ MB-75/MB-132 installation

An optional MB-75/MB-132 FLUSH MOUNT KIT is available for mounting the transceiver to a flat surface such as an instrument panel.

KEEP the transceiver and microphone at least 1 meter (3.3 feet) away from the vessel's magnetic navigation compass.

- ① Using the template on page 112, carefully cut a hole into the instrument panel, or wherever you plan to mount the transceiver.
- ② Slide the transceiver through the hole, as shown below.

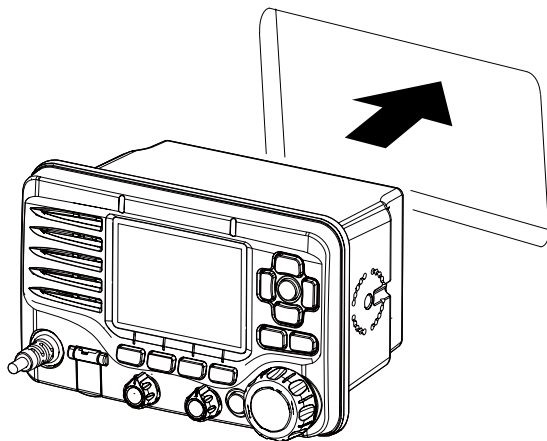

◇ MB-75 installation

- ① Attach the 2 supplied bolts (M5 × 8 mm) on either side of the transceiver.
- ② Attach the clamps on either side of the transceiver.
 - Make sure that the clamps align parallel to the transceiver's body.

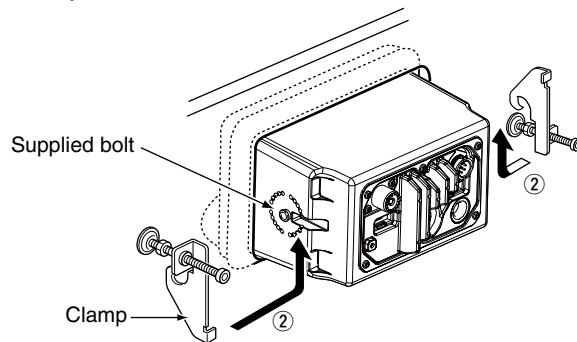

- ③ Tighten the end bolts on the clamps (rotate clockwise) so that the clamps press firmly against the inside of the instrument control panel. (Torque: 0.6 N•m)
- ④ Tighten the locking nuts (rotate counterclockwise) so that the transceiver is securely mounted in position as below.
- ⑤ Connect the antenna and power cable, then return the instrument control panel to its original place.

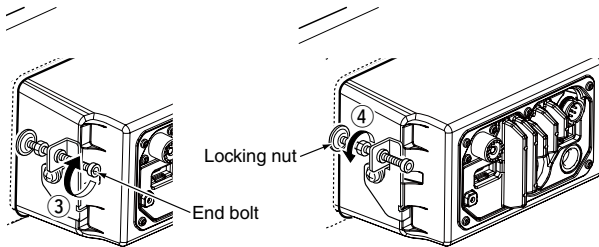

◆ MB-132 installation

- ① Attach the clamps on either side of the transceiver with 2 supplied bolts. (M5 × 8 mm)
 - Make sure that the clamps align parallel to the transceiver body.

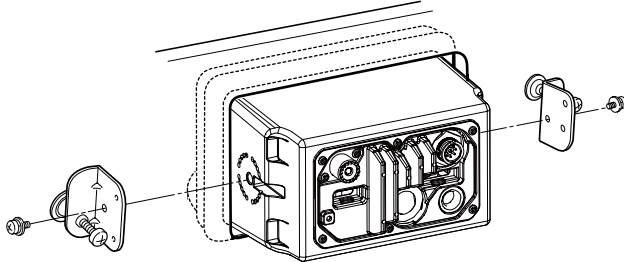

- ② Tighten the end bolts on the clamps (clockwise) so that the clamps press firmly against the inside of the instrument control panel.
- ③ Tighten the locking nuts (counterclockwise) so that the transceiver is securely mounted in position, as shown below.
- ④ Connect the antenna and power cable, then return the instrument control panel to its original place.

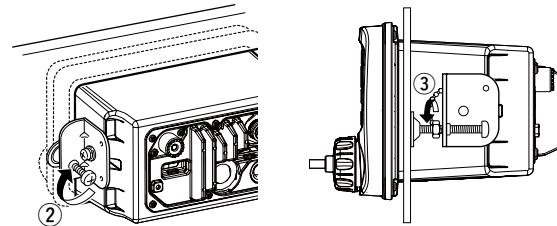

12 CONNECTIONS AND MAINTENANCE

■ Microphone installation

The supplied or optional HM-205* and the optional HM-195 should be connected to the transceiver using the connection cable that comes with the transceiver or the microphone.

The cable is used to operate from a longer distance. The cable connector can also be installed as a built-in plug on a cabinet or wall.

*Not supplied with some transceiver versions.

To operate from even longer distances, the optional 6 meter long OPC-999 or OPC-1541 extension cable can be used between the transceiver and the OPC-1000 or OPC-1540. Up to two OPC-999 or OPC-1541 can be added.

- OPC-999: For the HM-205
- OPC-1541: For the HM-195

◇ Installation

- ① Insert the connection cable connector into the microphone connector or the command microphone jack, and tighten the nut.
- ② To use the cable connector as a wall socket, install it as described below.
- ③ Using the mounting base as a template, carefully mark the holes where the cable and three screws will be fastened.
- ④ Drill holes at these marks.

- ⑤ Install the mounting base using the supplied screws, as shown below.

• HM-205

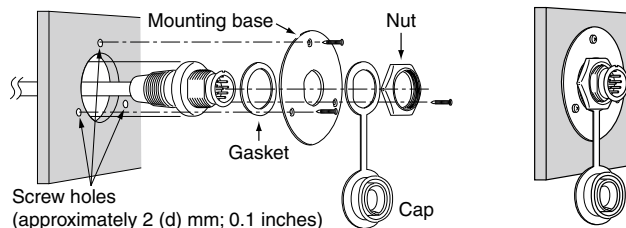

• HM-195

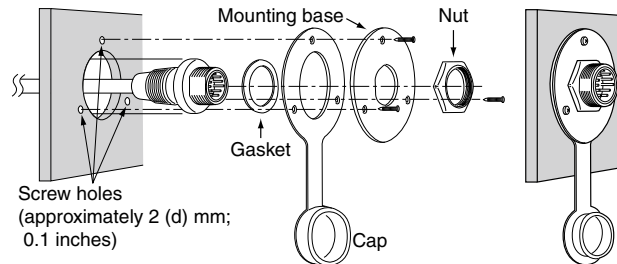

• HM-195

• HM-205

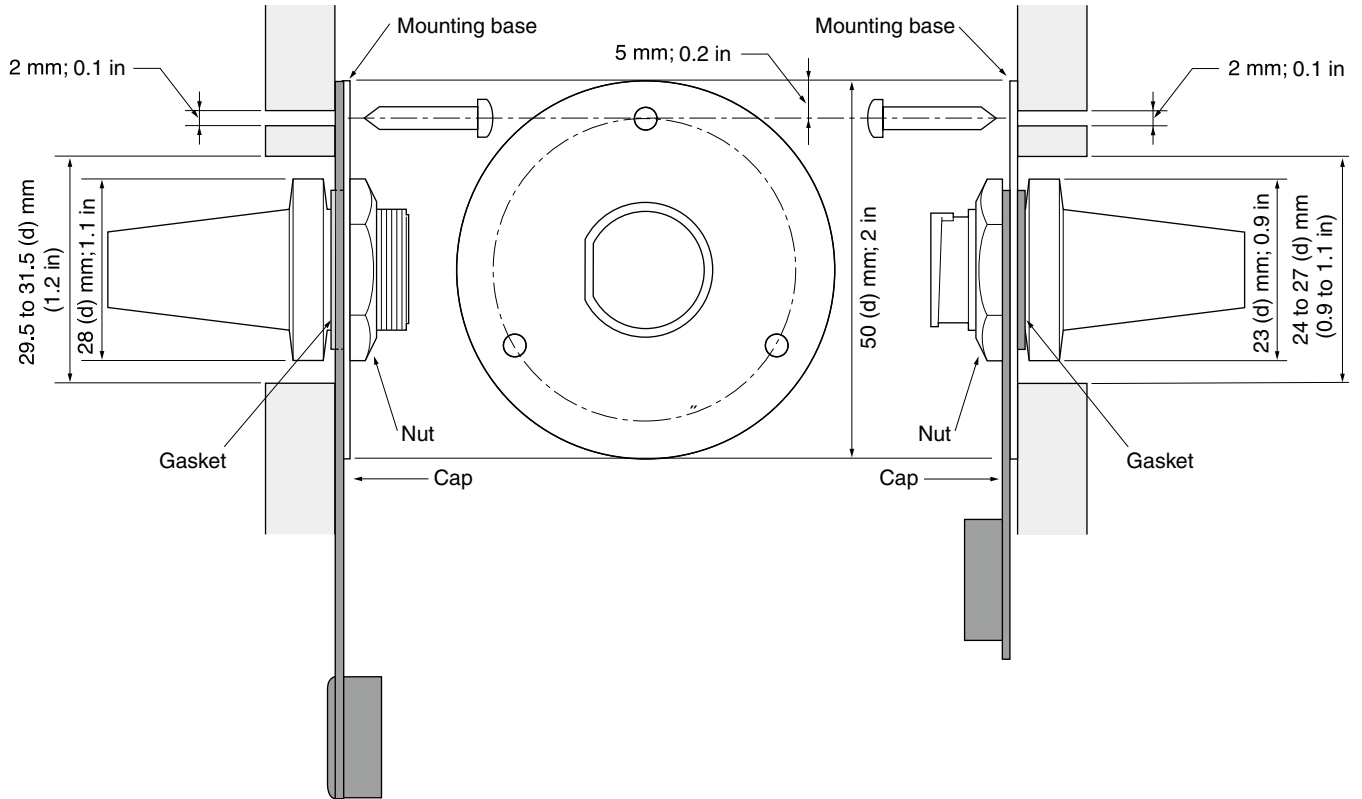

13 SPECIFICATIONS AND OPTIONS

■ Specifications

Measurements made without an antenna.

◇ General

- Frequency coverage:
Tx 156.025–157.425 MHz
Rx 156.050–163.275 MHz
CH70 156.525 MHz
- Mode:
FM (16K0G3E),
DSC (16K0G2B)
- Channel spacing:
25 kHz
- Operating temp. range:
–20°C to +60°C (–4°F to +140°F)
- Current drain (at 13.8 V):
TX high 5.5 A maximum
Max. audio 5.0 A maximum
(With EXT SP)
Max. audio 1.5 A maximum
(With INT SP)
- Power supply requirement:
13.8 V DC ±15%
(negative ground)
- Frequency tolerance:
±10 ppm (–20°C to +60°C;
–4°F to +140°F)
- Antenna impedance:
50 Ω nominal
- Dimensions:
178.9 (W) × 113.9 (H) ×
(Projections not included) 113.8 (D) mm
7 (W) × 4.5 (H) × 4.5 (D) inches
- Weight (approximately):
1.4 kg; 3.1 lb

◇ Transmitter

- Output power:
25 W/1 W
- Modulation system:
Variable reactance frequency
modulation
- Max. frequency deviation:
±5.0 kHz
- Spurious emissions:
Less than –70 dBc (high)
Less than –56 dBc (low)

◇ Receiver

- Receive system:
Double conversion
superheterodyne
- Sensitivity (12 dB SINAD):
–13 dBμ (typical)
–5 dBμ emf (typical)
(CH70/DSC) (1% BER)
- Squelch sensitivity:
Less than –7 dBμ
- Intermodulation rejection ratio:
More than 75 dB
More than 68 dBμ emf
(CH70/DSC) (1% BER)
- Spurious response rejection ratio:
More than 75 dB
More than 73 dBμ emf
(CH70/DSC) (1% BER)
- Adjacent channel selectivity:
More than 75 dB
More than 73 dBμ emf
(CH70/DSC) (1% BER)
- Audio output power:
More than 15 W at 10% distortion
with an external speaker
(4 Ω load)

All stated specifications are subject to change without notice or obligation.

◇ Dimensions

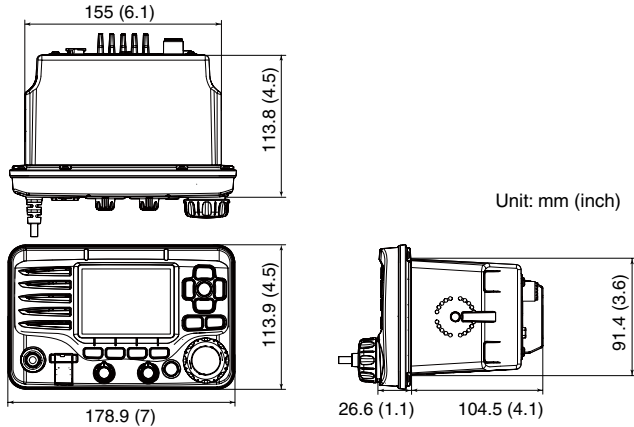

■ Options

- **MB-75/MB-132** FLUSH MOUNT KIT
To mount the transceiver to a panel.
- **HM-205B/HM-205RB** SPEAKER MICROPHONE
Equipped with [▲]/[▼] (channel up/down,) [H/L], [16/C] and [PTT] keys, a speaker and microphone.
- **MA-500TR** CLASS B AIS TRANSPONDER
To transmit individual DSC calls to a selected AIS targets.
- **HM-195B/HM-195SW** COMMANDMICIV™
External microphone-type controller. Provides optional intercom operation. 6 meters (20 feet) microphone cable and mounting base included. Black and white colors are available.
HM-195B: Black
HM-195SW: Super White
- **OPC-999** MICROPHONE EXTENSION CABLE
6 meters (20 feet) microphone extension cable for supplied or optional HM-205. Up to two OPC-999 can be connected. Usable length is 18 meters (60 feet) maximum.
- **OPC-1541** MICROPHONE EXTENSION CABLE
6 meters (20 feet) microphone extension cable for optional HM-195 COMMANDMICIV™. Up to two OPC-1541 can be connected. Usable length is 18 meters (60 feet) maximum.
- **UT-112** VOICE SCRAMBLER UNIT
Ensures private communications. 32 codes are available. Not available in some countries.
Ask your service center or technical dealer for installation details.

Approved Icom optional equipment is designed for optimal performance when used with an Icom transceiver. Icom is not responsible for the destruction or damage to an Icom transceiver in the event the Icom transceiver is used with equipment that is not manufactured or approved by Icom.

14 CHANNEL LIST

Channel Number			Frequency (MHz)		Channel Number			Frequency (MHz)		Channel Number			Frequency (MHz)						
USA	INT	CAN	Transmit	Receive	USA	INT	CAN	Transmit	Receive	USA	INT	CAN	Transmit	Receive	USA	INT	CAN	Transmit	Receive
	01	01	156.050	160.650	20A			157.000	157.000	66A	66A	66A*2	156.325	156.325	87	87	87	157.375	157.375
01A	01A		156.050	156.050		21		157.050	161.650	67*1	67	67	156.375	156.375	88	88	88	157.425	157.425
	02	02	156.100	160.700	21A	21A	21A	157.050	157.050	68	68	68	156.425	156.425		1019		156.950	156.950
	03	03	156.150	160.750	22	22		157.100	161.700	69	69	69	156.475	156.475		1020		157.000	157.000
	04		156.200	160.800	22A	22A	22A	157.100	157.100	71	71	71	156.575	156.575		1078		156.925	156.925
		04A	156.200	156.200		23	23	157.150	161.750	72	72	72	156.625	156.625		1079		156.975	156.975
	05		156.250	160.850	23A	23A		157.150	157.150	73	73	73	156.675	156.675		2019		RX only	161.550
05A	05A	05A	156.250	156.250	24		24	157.200	161.800	74	74	74	156.725	156.725		2020		RX only	161.600
06	06	06	156.300	156.300	25		25	157.250	161.850		75*2	75*2	156.775	156.775			21B	RX only	161.650
	07		156.350	160.950	26		26	157.300	161.900		76*2	76*2	156.825	156.825			23B	RX only	161.750
07A	07A	07A	156.350	156.350	27	27	27	157.350	161.950	77*2	77	77*2	156.875	156.875			25B	RX only	161.850
08	08	08	156.400	156.400		27A		157.350	157.350		78		156.925	161.525			28B	RX only	162.000
09	09	09	156.450	156.450	28	28	28	157.400	162.000	78A		78A	156.925	156.925			2078	RX only	161.525
10	10	10	156.500	156.500		28A		157.400	157.400		79		156.975	161.575			2079	RX only	161.575
11	11	11	156.550	156.550		60	60	156.025	160.625	79A		79A	156.975	156.975			83B	RX only	161.775
12	12	12	156.600	156.600		61		156.075	160.675		80		157.025	161.625					
13*1	13	13*2	156.650	156.650			61A	156.075	156.075	80A	80A	80A	157.025	157.025					
14	14	14	156.700	156.700		62		156.125	160.725		81		157.075	161.675					
15*3	15*2	15*2	156.750	156.750			62A	156.125	156.125	81A	81A	81A	157.075	157.075					
16	16	16	156.800	156.800		63		156.175	160.775		82		157.125	161.725					
17*2	17	17*2	156.850	156.850	63A	63A	63A	156.175	156.175	82A	82A	82A	157.125	157.125					
	18		156.900	161.500		64	64	156.225	160.825		83		157.175	161.775					
18A	18A	18A	156.900	156.900			64A	156.225	156.225	83A	83A	83A	157.175	157.175					
	19		156.950	161.550		65		156.275	160.875	84		84	157.225	161.825					
19A		19A	156.950	156.950	65A	65A	65A*2	156.275	156.275	85		85	157.275	161.875					
20	20	20*2	157.000	161.600		66		156.325	160.925	86		86	157.325	161.925					

*1 Momentary high power.

*2 Low power only.

*3 RX only.

NOTE: Simplex channels, 3, 21, 23, 61, 64, 81, 82 and 83 **CANNOT** be lawfully used by the general public in USA waters.

TEMPLATE 15

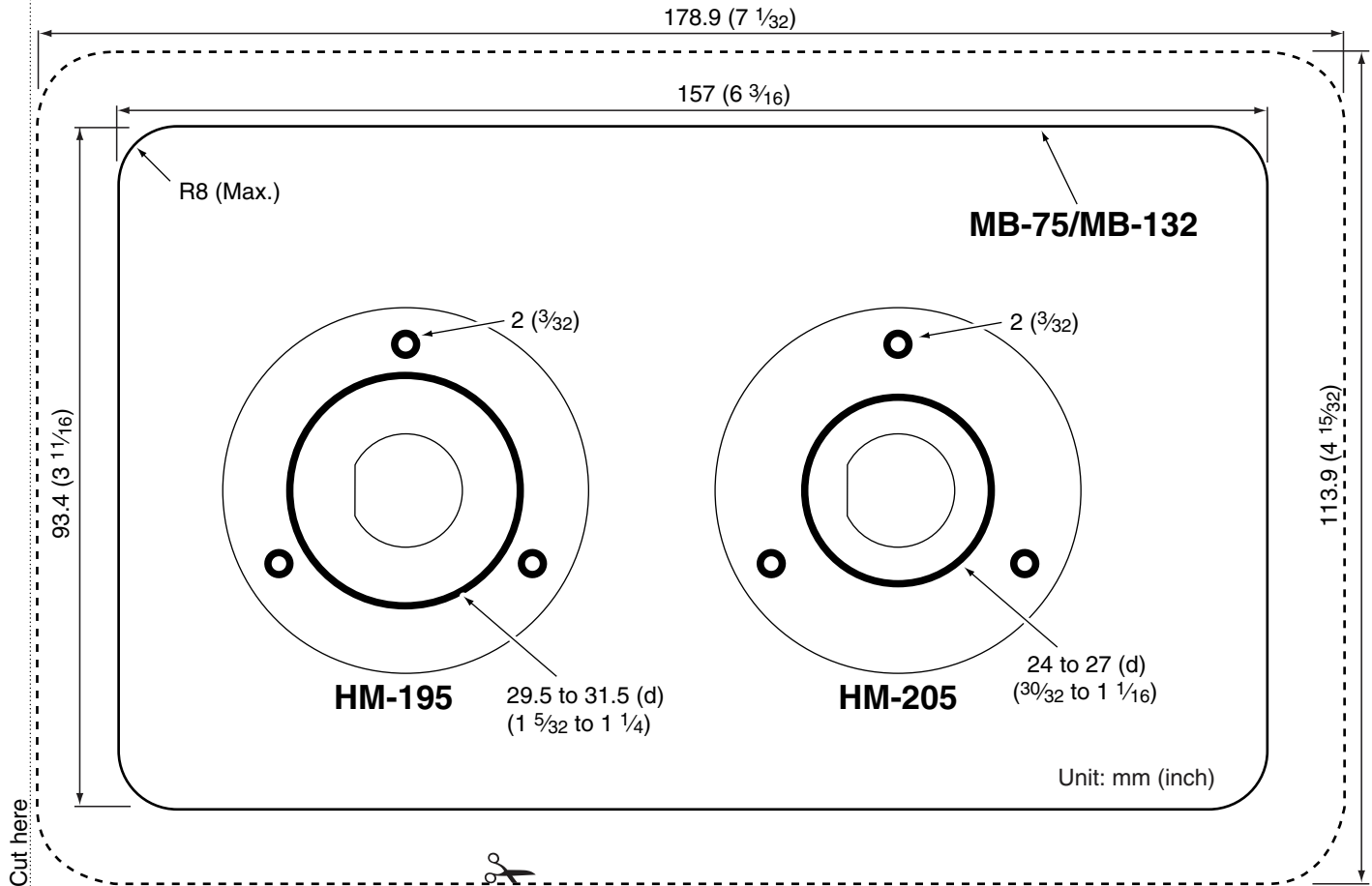

14
15

PROBLEM	POSSIBLE CAUSE	SOLUTION	REF.
The transceiver does not turn ON.	<ul style="list-style-type: none"> • Bad connection to the power supply. 	<ul style="list-style-type: none"> • Check the connection to the transceiver and power supply. 	p. 105
Little or no sound comes from the speaker.	<ul style="list-style-type: none"> • Squelch level is set too high. • Volume level is set too low. • Speaker has been exposed to water. 	<ul style="list-style-type: none"> • Set the squelch to the threshold point. • Set the volume to a suitable level. • Remove the water with the AquaQuake function. 	p. 3 p. 4 p. 15
Transmitting is impossible, or high power cannot be selected.	<ul style="list-style-type: none"> • Some channels are programmed for low power or receive only by regulations. • The output power is set to low. 	<ul style="list-style-type: none"> • Change channels. • Push [HI/LO] to select high power. 	pp. 9, 10, 11 p. 11
Scan does not start.	<ul style="list-style-type: none"> • More than 2 favorite channels are not programmed. 	<ul style="list-style-type: none"> • Set the desired channels as Favorite channels. 	p. 17
No beep sounds.	<ul style="list-style-type: none"> • Beep tones are turned OFF. 	<ul style="list-style-type: none"> • Turn the beep tones ON in the CONFIGURATION menu. 	p. 95
Distress calls cannot be transmitted.	<ul style="list-style-type: none"> • MMSI (DSC self ID) code is not programmed. 	<ul style="list-style-type: none"> • Program the MMSI (DSC self ID) code. 	p. 8
Does not record or does not record properly.	<ul style="list-style-type: none"> • The memory IC is not working. 	<ul style="list-style-type: none"> • The memory IC should be replaced. Ask your service center or technical dealer for details. 	—

Count on us!

A7129D-1US-4a
Printed in Japan
© 2014–2019 Icom Inc. Feb. 2019

Icom Inc.
1-1-32 Kamiminami, Hirano-ku, Osaka 547-0003, Japan