



RMDR (Reciprocal Mixing Dynamic Range) of 110 dB* (at 1 kHz)

Completely Independent Dual Receivers Receive Two Bands Simultaneously

High-Speed, High-Resolution Spectrum Waterfall Scope

High Stability, High Spectral Purity Local Oscillator

Full Duty 200 W Output Power

1.2 kHz Optimum Roofing Filter Greatly Improves In-band Adjacent Signal Performance

Audio Scope and Oscilloscope for Observing Receive and Transmit Audio

* At a 1 kHz offset frequency. Receive frequency: 14.2 MHz
Mode: CW, IF BW: 500 Hz, Roofing Filter: 1.2 kHz



Experience in video



http://www.icom.co.jp/r/ic-7851_me/

HF/50MHz TRANSCEIVER IC-7851

RMDR: 110 dB, Raising the Bar Again

Design advances developed by the Icom HF engineers for the Local Oscillator (LO) enable the IC-7851 to set a new benchmark for amateur radio receivers. The goal was to dramatically reduce the phase noise that degrades the target signal due to the sum of the entire signal present. The result was a RMDR of 110 dB*. Below is a comparison of the improvement over the IC-7800.

* At a 1 kHz offset frequency

Receive frequency: 14.2 MHz Mode: CW, IF BW: 500 Hz
Roofing Filter IC-7800 = 3 kHz, IC-7851 = 1.2 kHz

RMDR Comparison

	RMDR(dB)			
	1kHz	2kHz	10kHz	20kHz
IC-7851	110	116	121	124
IC-7800	78	87	106	112

RMDR

RMDR (Reciprocal Mixing Dynamic Range) is the relative level of an undesired signal, offset "n" kHz from the RX passband, which will raise noise floor by 3 dB. The local oscillator phase noise will mix with strong unwanted signals and unavoidably generate noise which masks a wanted signal.

1.2 kHz Optimum Roofing Filter

Despite the trend to switch to a down conversion or a hybrid conversion receiver design, Icom believes in the solid performance of the up-conversion design. The IC-7851 introduces a new 1.2 kHz Optimum Roofing Filter, greatly improving the in-band adjacent signal performance. This newly developed filter overcomes the gap of a narrower roofing filter in an up-conversion receiver.



Optimum Roofing Filter

Innovative LO Design

Breaking the boundaries of traditional designs, the IC-7851 employs a Direct Digital Synthesizer (DDS) along with a Phase Locked Oscillator for the LO (Local Oscillator). The C/N ratio excels beyond the IC-7800 and other similar class HF transceivers. This design significantly reduces noise components in both receive and transmit signals.

LO C/N Characteristics Comparisons

Receive Frequency: 14.2 MHz Mode: CW 1st LO frequency: 78.655 MHz
SPAN = 20 kHz, RBW = 30 Hz, VBW = 10 Hz

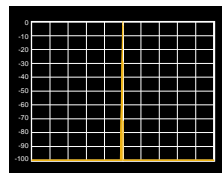

IC-7851

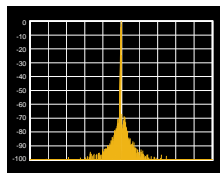

IC-7800

Improved Phase Noise Characteristics

Phase noise is coherent in radio circuit design, and the new LO design introduced in the IC-7851 makes some major breakthroughs while utilizing the 64 MHz, up-conversion receiver design introduced in the IC-7800. An impressive 20 dB improvement is seen with the IC-7851's 10 kHz measurement, and more than 30 dB improvement at a 1 kHz measurement in comparison to the IC-7800.

Phase Noise Characteristics Comparisons

Receive Frequency: 14.2 MHz Mode: CW 1st LO frequency: 78.655 MHz

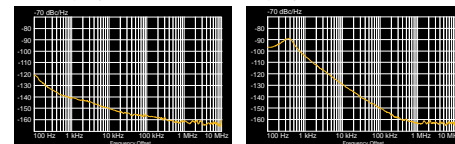

IC-7851

IC-7800

Improved Spectrum Scope

Following the design lineage of the IC-7800, the IC-7851 uses a dedicated DSP unit for the Fast Fourier Transform (FFT) spectrum. The 2250 MFLOPS DSP processor enables a new dual scope function, significantly faster sweep speeds, and better accuracy than in the IC-7800.

Scope Comparison

	IC-7851	IC-7800
Span Width	5 kHz-1000 kHz	5 kHz-500 kHz
Resolution **	1 pixel minimum **	20 pixels minimum **
Sweep Speed	29.3 frames/Sec **	4 frames/Sec **
Display Dynamic Range	100 dB	80 dB
Noise Floor Level	-30 dBμ	-19 dBμ

** Number of dots shown at the 60 dB level, when receiving a signal.

** SPAN = More than 20 kHz, SPEED = Slow

** SPAN = Less than 20 kHz, SPEED = Fast

** SPAN = 500 kHz, SPEED = Slow

Base Station



+40 dBm IP3 (3rd Order Intercept Point)

The IC-7851 continues the +40 dBm, 3rd order intercept point and 110 dB receiver dynamic range benchmark set by the IC-7800. To achieve this superb receiver performance, the entire analogue circuitry and components have been re-engineered to match the DSP units. A newly designed LO amplifier generates high output while keeping flat frequency characteristics over a 60 MHz wide range.

Dual Spectrum Scope with Waterfall Function

The IC-7851 introduces the new dual scope, enabling you to observe both receivers in separate spectrum scopes. The dual scope function is vital to watch for multipliers or band openings in contests, or working all bands/modes on a DXpedition. The waterfall display captures signal strengths over time. This enables you to see signals that may not be apparent on a normal scope.



Dual scope example (Horizontally aligned)

Full Duty 200 W Output Power

The push-pull power amplifiers using power MOS-FETs work on 48 V DC. They provide a powerful 200 W output power at full duty cycle. An effective cooling system maintains internal temperatures within a safe range and prevents thermal runaway.

Digital IF Filter

Icom's digital IF filters give you performance that is not possible with crystal or mechanical filters. They allow the operator to adjust filter shape (sharp or soft), filter bandwidth, and center frequency characteristics, without missing the action.

Other Outstanding Features

[Antenna and receiver] • Two completely independent receivers • 15 kHz, 6 kHz, 3 kHz and 1.2 kHz 1st IF Roofing filters • Four antenna connectors with automatic antenna selector

- Automatic antenna tuner
- 50 MHz special preamp and mixer circuit
- Digital manual notch
- Digital twin PBT eliminates interference from adjacent signals
- New auto digital noise blander
- ±0.05 ppm High Stability OXCO Unit
- [CW mode]** • DSP-controlled CW keying waveform shaping
- Multi-function electronic keyer with adjustable keying speed, dot-dash ratio and paddle polarity
- Audio Peak Filter selection (soft/sharp)
- [Operation]** • High-quality digital voice recorder memory
- Built-in RTTY, PSK31 and PSK63 without needing a computer
- Message memory for Voice, CW, RTTY and PSK31/63
- Digital video interface (DVI-I)
- SD memory card slot
- Audio scope function
- Mouse control spectrum scope
- AGC control
- Microphone equalizer and adjustable transmit bandwidth
- FFT scope averaging function for PSK and RTTY decode
- Screen saver function



**RMDR (Reciprocal Mixing
Dynamic Range) of 110 dB* (at 2 kHz)**

**Independent Dual Receivers
Receive Two Bands Simultaneously**

**Superior Transmit Phase Noise
Characteristics**

**DIGI-SEL Preselector for Main and
Sub Bands**

**High-Speed, High-Resolution
Real-time Spectrum Scope**

**Touch Screen and Multi-Dial Knob
for Smooth Operation**

**DVI-D Digital Connector
for External Display Connection**



* At a 2 kHz offset frequency. Receive frequency:
14.2 MHz Mode: CW, IF BW: 500 Hz

HF/50MHz TRANSCEIVER IC-7610

Innovative RF Direct Sampling System Achieves 110 dB* (typ) RMDR

The RF direct sampling system directly converts the analogue signals to digital signals, and collectively puts the data through FPGA (Field-Programmable Gate Array) processing. The master clock uses a high precision VCXO (Voltage Controlled Crystal Oscillator) which excels in low-noise characteristics. This makes it possible to provide superior receive and transmit performance, extremely low phase noise as well as high RMDR (Reciprocal Mixing Dynamic Range).

* At 2 kHz frequency separation.

■ RMDR Characteristics

* Receive frequency: 14.2 MHz, MODE: CW, IF BW: 500 Hz

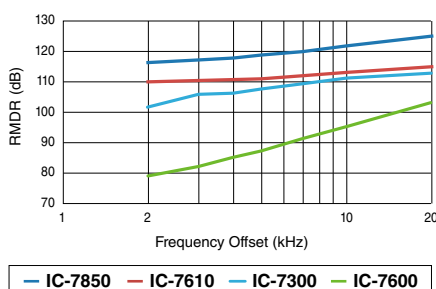

Independent Dual Receivers Receive Two Bands Simultaneously

The dual receivers are ideal for simultaneous monitoring of two bands and two modes. The sub receiver works independently of the main receiver. The optional RC-28 can be used as for main dial and/or the sub dial.

Superior Transmit Phase Noise Characteristics

Breaking with the tradition of mixing a carrier signal with a local oscillator, a Digital-Up-Conversion (DUC) is used to generate required frequencies by sampling in the Digital to Analogue Converter (DAC). The superior Phase Noise characteristics provide high purity transmit signals.

DIGI-SEL Firmly Shuts Out Interfering Signals

Both main and sub receivers are equipped with DIGI-SEL (digital preselector) units. The DIGI-SEL has steeper skirt characteristics than normal band-pass filters, so it rejects out of band strong interference, such as broadcast stations, and prevents cross modulation.



DIGI-SEL Unit

High-Speed, High-Resolution Real-time Spectrum Scope

The real-time spectrum scope of the IC-7610 shows main and sub band conditions. It provides class-leading performance in resolution, sweep speed and a 100 dB of dynamic range. The waterfall screen enables you to find weak signals by showing the spectrum change over time. Connecting a PC mouse to the USB port aids in flexible use of the spectrum scope.

FFT Scope and Oscilloscope for Audio Observation

The audio scope function shows the FFT scope with waterfall and the oscilloscope of either transmit or receive audio. This function can be used to observe various AF characteristics such as microphone compressor level, filter width, notch filter and receive keying waveform in CW mode.

Touch Screen and Multi-Dial Knob for Smooth Operation

The combination of the touch screen and the multi-dial knob offers quick and smooth operation. When you push the multi-dial knob, menu items are shown on the right side of the display. You can select an item with a touch of the screen, and adjust levels by rotating the multi-dial knob.

Base Station



DVI-D Connector for an External Display Connection

The IC-7610 has a DVI-D connector for an external display. Operating frequency, setting information and spectrum scopes can be observed on a large external display.

High Sound Quality Speaker

The IC-7610's speaker offers comfortable sound quality with flat overall frequency response and loud and intelligible audio of the high-purity received signal. Insulators are placed between the speaker and chassis for preventing vibration noise.

SD Card Slot and USB ports for Data Saving

For multi-operators using one rig, personal settings such as filter settings, Memory channels, and antenna settings, can be saved and loaded using the SD card/USB memory stick. TX Voice memories and RTTY/CW memories on the SD card/USB memory stick can be sent with a touch of a button.

I/Q Signal Output

The I/Q signal output function* enables you to derive digital IF signals from the I/Q output jack.

* This function will be provided with a future firmware update.

Other Outstanding Features

[Antenna and receiver] • BNC type RX IN/OUT connectors • Built-in automatic antenna tuner • Two types of preamplifiers • 3 dB – 45 dB attenuator • IP+ function improves third order intercept point performance • RTTY demodulator and decoder • Digital twin PBT eliminates interference from adjacent signals

[Transmitter] • TX monitor function • All mode power control • VOX (voice operated transmission) capability • Microphone equalizer and adjustable transmit bandwidth • 50 CTCSS tones

[CW mode] • FPGA-controlled CW keying waveform shaping • Multi-function electronic keyer • CW pitch control from 300 Hz to 900 Hz • Auto repeat function • Contest serial number counter • Normal or short morse

number style • Double key jack system • Full break-in and semi break-in • CW auto tuning • APF (Audio Peak Filter) function adjustable filter position, width, type and AF level

[Operation] • 7-inch wide colour TFT LCD • Simplified IP remote control capability with the optional RS-BA1 • Memo pad stores up to 10 operating frequencies and modes • Quick Split function • Quick Dual watch function • RF gain and squelch control with a knob • RIT and Δ TX variable up to 9.999 kHz • UTC/local clock and timer function • 1 Hz pitch tuning and display • 101 Memory channels • Dial lock function • Adjustable main dial friction • External speaker jacks for main and sub receivers • Multi-function meter • Auto tuning step function • AGC control for fine tuning of the AGC time constant • Screen saver function





HF/50MHz TRANSCEIVER **IC-7700**

+40 dBm Third-Order Intercept Point (in the HF Bands)

Spectrum Scope with Waterfall Function

200 W Output Power and High-stability Transmitter

+40 dBm IP3 (3rd order Intercept Point) and 110 dB Dynamic Range

The IC-7700 employs mechanical relay BPF switching, a digitally tuned preselector, and three hi-spec 1st IF filters (roofing filters) in a clean and simple double conversion superheterodyne design. By balancing the analogue and DSP functions, the IC-7700 provides superior sensitivity simultaneously with a superb dynamic range of 110 dB, and +40 dBm IP3 (even in the USB mode with a 2.4 kHz filter bandwidth).

More than +110 dBm IP2 (2nd order Intercept Point)

An IP2 point of more than +110 dBm* means 2nd order distortion from strong broadcast stations will be completely eliminated.

* The IP2 figure is a typical value.

** Measurements were made using custom equipment, due to the limits of normal signal generators (SG) and duplexers of +85 dBm.

High Specification Inband IMD

All (2nd, 3rd or even higher) orders of IMD performance are superior in the IC-7700. You'll notice the difference as you copy weak signals without internal distortion or noise, especially evident in the CW mode.

Spectrum Waterfall Display

The spectrum waterfall function can show the changing amplitude of frequency spectrum over time. A weak signal which cannot be recognized with the spectrum scope may be found in the waterfall screen. With the high performance receiver, the IC-7700 increases your chances of making QSOs.



Spectrum scope with waterfall (wide screen setting)

Mouse Operation for Spectrum Scope

By connecting a PC mouse to the USB port, the spectrum scope operation is possible with a mouse.

Audio Scope Function for AF Observation

The audio scope function can be used for observing various AF characteristics such as microphone compressor level, filter width, notch filter and CW keying waveform.

200 W Full Duty Operation

The IC-7700 uses a STAC2942 power amplifier in a push-pull configuration. The digital PSN modulator consistently produces an outstanding signal-to-noise ratio, providing clean and low IMD transmission on all bands.

Other Outstanding Features

- Simplified remote control operation with optional RS-BA1
- QSO recording function into USB flash drive
- 15 kHz, 6 kHz, and 3 kHz Hi-spec 1st IF filters (roofing filter)
- Image rejection mixer is used for the 2nd mixer
- Low distortion bandpass filter and mechanical relays
- DIGI-SEL automatic preselector rejects out of band strong interference
- High Intercept point and low noise preamplifier
- Two AGC loop lines improve dynamic range and blocking from strong interference
- ±0.05 ppm high stability OXCO unit
- RTTY and PSK 31 operation without PC connection
- USB connectors on the front panel
- 4 antenna connectors with automatic antenna selector
- Digital twin PBT eliminates interference from adjacent signals
- Flexible digital IF filter setting
- Manual and auto notch filter
- Microphone equalizer and adjustable transmit bandwidth
- VGA connector for an external display connection

Firmware Update Available (Free Download)
<http://www.icom.co.jp/world/support/index.html>

Dynamic range characteristics (in 14MHz band)

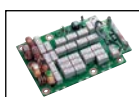
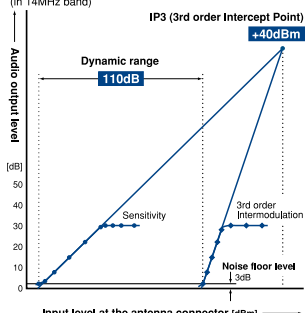

DIGI-SEL unit



BPF unit

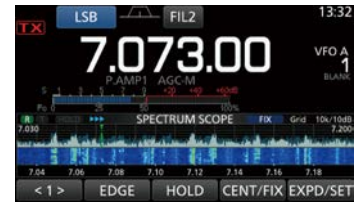

Spectrum scope + Waterfall



FFT scope/Oscilloscope



Touch screen interface

HF/50/70MHz TRANSCEIVER IC-7300

Class Leading Real-time Spectrum Scope with Waterfall Function

RF Direct Sampling System

New "IP+" Function

Class Leading Real-time Spectrum Scope with Waterfall Function

The IC-7300's real-time spectrum scope is class-leading in resolution, sweep speed and dynamic range. While listening to received audio, you can check the real-time spectrum scope and quickly move to an intended signal.

Real-time Spectrum Scope Specifications

	IC-7300
Scope system	FFT (Fast Fourier Transform)
Span width	5 kHz-1000 kHz
Resolution *	1 pixel minimum (approximately)
Sweep speed	Max. 30 frames/second (approximately)
Waveform display area (vertical axis)	80 dB
Other functions	Waterfall function, Audio scope function

* Number of pixels shown at the 60 dB level, when receiving a signal.

RF Direct Sampling System

The IC-7300 employs an RF direct sampling system. RF signals are directly converted to digital data and processed in the FPGA (Field-Programmable Gate Array), making it possible to simplify the circuit construction. This system is the new benchmark technology making an epoch in amateur radio.

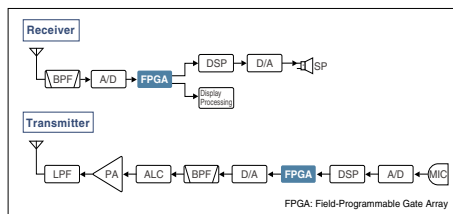

Class Leading RMDR and Phase Noise Characteristics

The IC-7300's RMDR is improved to about 100 dB* (typical value) and Phase Noise characteristics are improved about 20 dB (at 2 kHz frequency separation) compared to the IC-7200. The superior Phase Noise characteristics reduce noise components in both receive and transmit signals.

* At 2 kHz frequency separation (received frequency: 14.2 MHz, MODE: CW, IF BW: 500 Hz)

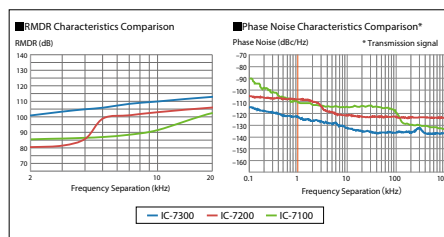

New "IP+" Function

The new "IP+" function improves the third order intercept point (IP3) performance. When a weak signal is received adjacent to strong interference, the AD converter is optimised against signal distortion.

15 Discrete Band-pass Filters

The IC-7300 has 15 discrete RF bandpass filters. The RF signal is only passed through one of the bandpass filters, while any out of range signals are rejected. High Q factor coils are used to minimize the loss in the RF band-pass filters.

Superior Signal Quality

The RF direct sampling system is naturally superior at signal linearity and noise immunity by digitally processing the signal from RF to AF. Mathematical frequency conversions within the FPGA drastically improve the signal purity. Thanks to these features, though it is a compact radio, the IC-7300 enjoys exceptionally clear and rich sound which normally can only be expected from a higher class radio.

Large Touch Screen Colour TFT LCD

The large 4.3 inch colour TFT touch LCD offers intuitive operation. Using the software keypad, you can easily set various functions and edit memory contents.

Other Features

- Audio scope function
- Built-in automatic antenna tuner
- Multi-dial knob for smooth operation
- SD card slot for saving data
- New speaker unit design
- HM-219 hand microphone supplied
- A large and effective cooling fan system
- Multi-function meter
- 101 Memory channels (99 regular, 2 scan edges)
- Optional RS-BA1 IP remote control software (the spectrum scope with the waterfall can be observed)
- CW functions: Full break-in, CW reverse, CW auto tuning
- 70 MHz operation is possible in the European transceiver version

Base Station



HF TRANSCEIVER IC-718



Simple, Straightforward Operation with Keypad

Front Mount Loud Speaker

Optional DSP Capability, UT-106

Simple, Straightforward Operation with Keypad

The IC-718 is equipped with a minimum number of buttons and controls for simple feature selection. The 10-key pad on the front panel enables direct entry of an operating frequency or a Memory channel number. The auto tuning step function is activated when turning the dial quickly and helps speed up tuning. The band stacking register is convenient when changing operating bands.

Front Mount Loud Speaker

The IC-718 has the speaker mounted on the front panel. With the speaker facing the operator, audio will be heard clearly and directly while operating.

Optional DSP Capability, UT-106

The optional DSP unit gives you noise reduction and auto notch filter functions for extra receiver performance.



Optional UT-106

General Coverage Receiver

The IC-718 has 0.03-29.999 MHz* general coverage receive capability.

* Guaranteed range: 0.5-29.999 MHz

Interference rejection – IF shift

To reject interference, the IC-718 has an IF shift function which shifts the center frequency of the IF passband electronically to reduce adjacent interference.

Other Features

- Front mounted loud speaker
- General coverage receiver
- Built-in electronic keyer
- Built-in microphone compressor
- Combined squelch and RF gain control
- Preamplifier and attenuator
- 101 Memory channels
- CW full break-in
- IF shift interference rejection
- 1 Hz tuning
- VOX function for hands-free operation
- Optional automatic antenna tuner
- Digital S/Rf meter

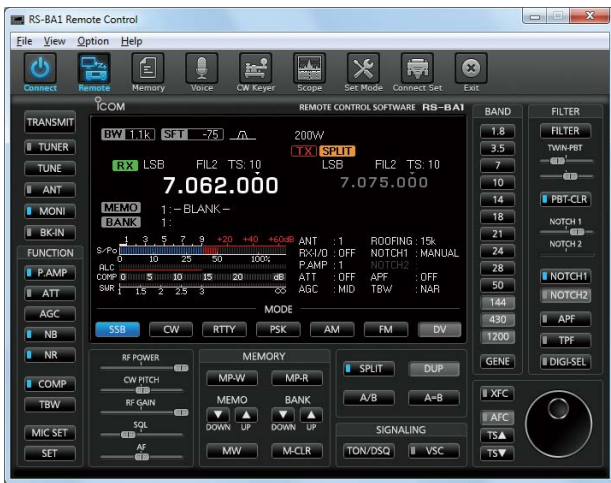

Advanced Remote Control Interface Tailored to Icom Transceivers

- Slider control or tuning knob control screens are selectable for RF power, CW pitch, RF gain, and SQL and AF level.
- The spectrum scope with the waterfall function can be observed on the RS-BA1. (For a single band on only the IC-7851, 7850, 7610 and 7300)
- Rx Voice recording function.

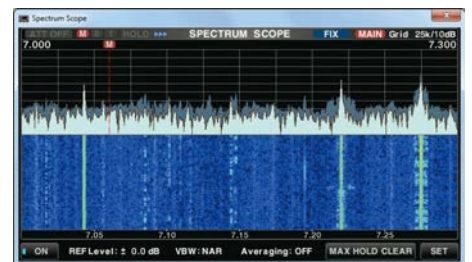

Waterfall spectrum scope

IP REMOTE CONTROL SOFTWARE RS-BA1



Remotely Control Icom Transceivers through an IP Network*

- The RS-BA1 enables you to use the transceiver installed in another room, or even from a remote location over the Internet.
- Low latency, high quality audio over an IP network.
- Most functions and modes of your transceiver, including interference rejection functions and IF filter settings, can be controlled using CI-V commands.
- Remote power ON/OFF function wakes up certain transceivers from the standby mode.

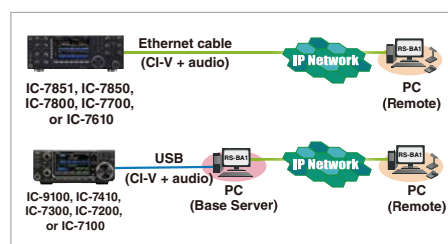

* A static public IP address (including Dynamic DNS) is required to the base station (Server) PC, when you configure the remote control system through the Internet.

Optional RC-28 USB Remote Encoder

The optional remote encoder provides a hardware dial/transmit function for realistic dial operation.



Software Update Available (Free Download)
<http://www.icom.co.jp/world/support/index.html>

DIGITAL



DR (D-STAR Repeater) mode operation



Near repeater function



SD card slot for saving data

HF/VHF/UHF TRANSCEIVER **IC-7100**

Intuitive Touch Screen Interface

Controls at Your Fingertips
with an Angled Display

HF, 50/70/144/430 MHz Multi-band

Intuitive Touch Screen Interface

The innovative touch screen interface provides quick and smooth operation for setting and editing various functions and memories.

One Touch Selection

For example, if you want to change the operating band, touch the frequency on the display. The band keys will be shown to select the operating band. Touching the multi-function meter indicator for 1 second will quickly change the transmit meter functions.



Straightforward Operation

Just touch the mode, filter, function etc., you need to change. The touch screen responds naturally changing your settings.



HF, 50/70/144/430 MHz Multi-band

The IC-7100 fully covers the HF, 50, 70, 144, 430 MHz amateur bands in multiple modes, providing 100 W on HF/50 MHz bands, 50 W on 70/144 MHz band and 35 W on 430 MHz band.

Digital Features Controlled by the IF DSP

A high-performance 32-bit floating point IF DSP delivers rich digital signal processing features, including digital IF filter, digital twin PBT, noise reduction, CW auto tune, etc. Those digital features work on all bands from HF to V/UHF bands.

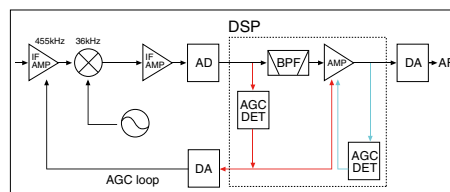

AGC function loop

Built-in RTTY Functions

The built-in RTTY decoder enables you to instantly read an RTTY message on the display. Your RTTY operating log, both TX and RX, can be recorded on an SD card. The eight RTTY memories can memorize and transmit often used RTTY sentences.

D-STAR DV Mode (Digital Voice + Data)

The IC-7100 provides D-STAR (Digital Smart Technology for Amateur Radio) DV mode digital voice and low-speed data communication.

DR (D-STAR Repeater) Function Operation

The DR function operation makes the D-STAR operation simple and straightforward, even if you are new to D-STAR.

Repeater Search Function

With an external GPS receiver*, this function searches nearby D-STAR repeaters from the internal database, based on your location.

* External GPS receiver or manual position data input required.

Controller Mounted Speaker and Jacks

The unique remote head design is perfect for providing loud, clear audio as well as jacks for an external speaker/headphones, key and microphone.

Controller Rear Panel View



SD Card Slot for Saving Data

When used with an SD card, the SD card can store various contents, including voice memory, Memory channels, and D-STAR repeater memories. Other personal settings can be saved to the SD card and loaded into the transceiver.

Other Features

- DSP controlled AGC function loop
- Easy vehicle mounting with the optional MBF-1
- RS-MS1A remote control software for an Android™ devices (Send and receive pictures)
- Optional RS-BA1 IP remote control software
- CW full break-in, CW receive reverse, CW auto tuning
- Optional multi-function microphone, HM-151
- Band scope and SWR graphic display
- RF speech compressor controlled by the DSP
- Voice memory function
- Multi-function meter
- 495 regular, 4 call, 6 scan edge and 900 DR mode repeater channels
- 4 TX voice memories
- ±0.5 ppm frequency stability
- Auto reply function*
- Digital call sign squelch (DSQL) and digital code squelch (CSQL)*
- 12.5 kHz IF output for DRM (Digital Radio Mondiale) receive

* D-STAR DV mode only

Firmware Update Available (Free Download)
<http://www.icom.co.jp/world/support/index.html>

DIGITAL (With optional UT-121)



HF/VHF/UHF TRANSCEIVER

IC-9100

**Multi-band,
Dual Independent Receiver**

**+30 dBm Class Third-order
Intercept Point (IP3)**

Satellite Mode Operation

Multi-band, Dual Independent Receiver

The IC-9100 has 3 independent receiver circuits from the antenna connector to the second IF mixer (image rejection mixer) and simultaneously receives two different bands (1. HF/50 MHz + 144/430 MHz, 2. 144 MHz + 430 MHz) at a time. The radio covers 100W on HF, 50 MHz and 144 MHz, 75 W on 430 MHz bands.

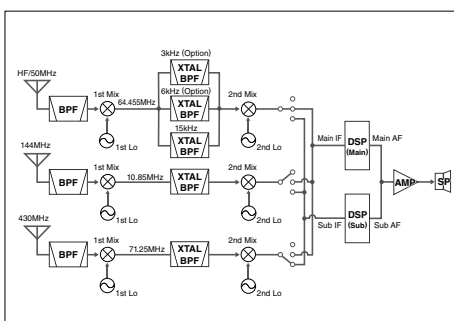

+30 dBm Class IP3

Using receiver design techniques introduced in Icom's highest grade HF transceivers, the IC-9100 has an IP3 of +30 dBm* in the HF band. Even a weak signal adjacent to strong signals is clearly received by the IC-9100.

* Typical in 14 MHz band. Spacing=100 kHz

Satellite Mode Operation

The satellite mode synchronizes the uplink (transmitting) and downlink (receiving) frequencies, and tracks the frequencies in the same tuning step. This function matches both normal and reverse mode satellites. Compensation of the Doppler effect can be performed easily. 20 satellite memory channels store frequencies, mode and tone settings for quick setup.

Superb readability in the VHF/UHF band

The IC-9100 has top class receiver performance in the VHF/UHF bands, indispensable for obtaining weak signals in satellite communication. The IF DSP greatly improves intermodulation and noise elimination, and offers good readability.

Optional D-STAR DV Mode

The optional UT-121 provides D-STAR DV mode digital voice and low speed data communication. Linking of D-STAR repeaters over the Internet enables you to communi-



▲Optional UT-121

cate virtually anywhere. The D-STAR repeater (DR) function makes it easy to access D-STAR repeaters.

Three First IF Filters (3/6/15 kHz) for HF/50 MHz Band

The IC-9100 comes with a built-in 15 kHz 1st IF filter, and can accept up to two optional filters (3 kHz FL-431 and 6 kHz FL-430). By changing the first IF filter width, depending on the operating mode, the desired signal is protected from adjacent inband signals at the later stages, for better receiver performance.



1st IF filters (6 kHz, 3 kHz)

USB Connector for PC Control

The IC-9100 has a standard type B USB connector and can be connected to a PC. Modulation input, audio output, RTTY demodulator output and CI-V command can be controlled through the USB cable.

Other Features

- 32-bit DSP and double conversion superheterodyne system
- AGC loop management
- Digital IF filter
- Digital twin PBT and IF shift
- Noise reduction
- Noise blanker
- RF speech compressor
- Adjustable transmit bandwidth
- RTTY demodulator and decoder
- Ample CW functions
- Built-in antenna tuner for HF/50 MHz band
- Digital notch filter
- Large, multi-function LCD
- Optional CS-9100 programming software
- Optional RS-BA1 IP remote control software

DIGITAL



ID-51E PLUS2

ID-31E PLUS

VHF/UHF DIGITAL TRANSCEIVER

ID-51E PLUS2

UHF DIGITAL TRANSCEIVER

ID-31E PLUS

Lightweight and Compact Design

Terminal Mode and Access Point Mode

VHF/VHF, UHF/UHF, VHF/UHF Dualwatch (ID-51E PLUS2 only)

Lightweight & Compact Design

The ID-51E PLUS2 is a 5 W VHF/UHF dual bander, and the ID-31E PLUS is a 5 W UHF single bander, both with D-STAR and integrated GPS receiver.



ID-51E PLUS2

ID-31E PLUS

Terminal Mode*

Connect the ID-51E PLUS2 or ID-31E PLUS to the Internet through a PC or Android™ device, and send your voice and/or data through the Internet gateway to a destination repeater.



Access Point Mode*

Use an ID-51E PLUS2 or ID-31E PLUS radio connected to the internet through a PC or Android™ device, as an access point. You can use another D-STAR radio to send your voice and/or data through the access point radio, and communicate with D-STAR stations all over the world.



* The optional free download software, RS-MS3W or RS-MS3A is required to be installed in the PC/Android™ device for terminal mode and access point mode operation. The OPC-2350LU data cable is required.

V/V, U/U, V/U Dualwatch (ID-51E PLUS2 only)

The Dualwatch function monitors VHF/VHF, UHF/UHF and VHF/UHF bands simultaneously.* The audio and squelch levels can be set separately for the main and sub-bands.



U/U Dualwatch example

* DV/DV, AM/AM, FM-N/FM-N and DV/FM-N modes Dualwatch not available.

Independent AM/FM Receiver (ID-51E PLUS2 only)

FM and AM broadcast and VHF airband stations can be listened to while using the Dualwatch function, to monitor the ham bands.

DV/FM Repeater Search Function

The repeater search function searches for up to 20 nearby DV/FM repeaters using the repeater memories and the integrated GPS*.

* To use the repeater search function, the position data of the repeater is required.

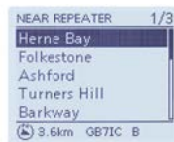

Repeater list example

DV Fast Data Mode*

By using data in place of voice frames, the ID-51E PLUS2 or ID-31E PLUS transfers data 3.5 times faster (3480 bps) than in the conventional DV mode (with voice). Pictures taken by an Android™ device can be transmitted in the DV Fast Data mode faster.

* The DV Fast Data mode is not compatible with the DV mode low-speed data communication.

Integrated GPS Receiver

The integrated GPS receiver provides fast start-up time and accurate location. GPS location information can be used for Auto Reply function. When receiving a call addressed to your call sign, the radio can automatically reply your current location information.

microSD Card Slot

When used with a microSD card, various contents including communication contents, voice audio, communication log, RX history log and GPS log data can be stored. Memory channels and other settings can be saved and loaded into the transceiver.

IPX7 Waterproof Construction

Both radios have superior IPX7 waterproof protection (one meter depth for 30 minutes). They can be used in harsh outdoor environments, or when hiking, mountain biking, touring and doing various outdoor sports.

RS-MS1A Remote Control Software (Free download Android™ application from Google Play™)

The RS-MS1A enables you to connect to the radio with an Android™ device and remotely set DR functions, link with a map application and send/receive messages over the DV mode.

* The OPC-2350LU data cable is required.

Red, Gold and Silver Colour Versions (ID-31E PLUS only)

The ID-31E PLUS has red, gold and silver colour choices for your preference.



Other Features

- 200 GPS memory channels • 5 W output power • Three hour rapid charging with supplied wall charger (BP-271) • Long lasting battery pack • CS-51PLUS2 or CS-31PLUS programming software supplied • Dplus Reflector link commands • Enhanced D-PRS functions

D-STAR Repeaters



ID-RP2C
Repeater controller



ID-RP2D
1.2GHz DD mode module



ID-RP2V
1.2GHz DV mode module



ID-RP2000V
144 MHz DV mode module



ID-RP4000V
430/440 MHz DV mode module



RS-RP3C
Internet gateway software

DIGITAL



DV/DV Dualwatch

The ID-5100E can receive both FM/FM and FM/DV mode signals simultaneously. Two DV mode signals can be monitored for receive on either channel. You can check other repeaters or other channel activities while waiting for the main repeater.

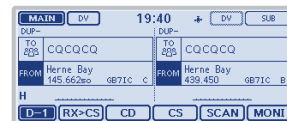

DV/DV Dualwatch (DR function) example

* Main band audio has priority if two DV signals are received at the same time.

DV/FM Repeater Search Function

The DV/FM repeater search function assists you in accessing nearby repeaters, even in areas you are visiting for the first time. The function searches for a nearby repeater using the repeater memories with the GPS location information.

* To use the repeater search function, the position data of the repeater is required.

Other Features

- SD card slot • VS-3 Bluetooth® headset • RS-MS1A Android™ application • DV fast data mode • 50 W output power • Repeater memory channels increased to 1500 • CTCSS and DTCS with Split tone function • Sub band mute auto • D-PRS functions • Convenient memory contents management using CSV format • Speech function announces the operating frequency, mode and received call sign (DV mode) • Independent main, volume and SQL knobs for A/B bands • AM airband Dualwatch • CS-5100, programming software supplied • 1750 Hz tone burst

Firmware Update Available (Free Download)
<http://www.icom.co.jp/world/support/index.html>

VHF/UHF DIGITAL TRANSCEIVER ID-5100E

Intuitive Touch Screen Operation

DV/DV Dualwatch

Integrated GPS Receiver

Intuitive Touch Screen Operation

The intuitive touch screen interface provides quick and smooth operation. The large 5.5 inch display (320 × 128 pixels) responds naturally to the touch – allowing you to change settings, enter frequencies and edit Memory channels with ease.



Vehicle installation example (Using optional MBF-1 mount base and MBA-2 controller bracket)

Integrated GPS Receiver

The integrated GPS receiver shows your own location, course, speed and altitude on the display. The GPS location information can be used for exchanging location reports, tracking the GPS log, and more.



Selectable LCD/key backlight colour

DIGITAL



DR (D-STAR Repeater) Function

The DR function makes D-STAR communications simple. By simply selecting a destination call sign in “To”, and your access repeater in “From”, you can talk with other D-STAR users.

Easy-to-Read Full Dot-Matrix Display

To increase the amount of display information, a full dot-matrix display is used in the ID-4100E.



GPS position information

Repeater list

DV/FM Near Repeater Search Function

The DV/FM near repeater search function assists you in accessing nearby repeaters, even in areas you are visiting for the first time.

* To use the repeater search function, the position data of the repeater is required.

Other Features

- Applications for iOS™ (RS-MS11) and Android™ (RS-MS1A) devices • Wireless audio with optional UT-137 Bluetooth® unit • DV fast data mode • microSD card slot • Integrated GPS receiver • Wide band receiver (118–174 and 230–550 MHz)* • Memory/Bank scan, Full scan, Band scan, Program scan, Program link scan, Duplex scan, Tone scan and DR scan • 16 channels of DTMF memory (24-digit) • CTCSS and DTCS with Split tone function • 8.33 kHz air band channel reception

* Receiver range differs depending on version.

VHF/UHF DIGITAL TRANSCEIVER ID-4100E

Terminal Mode and Access Point Mode

Compact, Detachable Controller for Flexible Installation

DR Function with the Latest Icom User Interface

Terminal/Access Point Mode*

Terminal and Access Point modes* enable you to enjoy long-distance D-STAR communication through the Internet. You can access D-STAR repeaters through the Internet, regardless of locations and conditions of nearby repeaters.

* An optional RS-MS3W/RS-MS3A free download software is required to be installed in the PC/ Android™ device. Please see p.10 for function details.

Compact, Detachable Controller

The controller can be attached or detached from the main unit for flexible installation. By using the supplied OPC-837 controller cable, you can install the controller up to 3.5 meters away from the main unit.



VHF FM TRANSCEIVER IC-V80E

750 mW Loud Audio

Powerful 5.5 W of Output Power

IP54 and MIL-STD-810 Rugged Construction

750 mW Loud Audio

The IC-V80E uses the BTL (bridge-tied load) amplifier that doubles the audio output. The 36 mm large speaker delivers 750 mW of loud and intelligible audio*. Great for noisy environments.

* Typical value using with internal speaker.

Powerful 5.5 W of Output Power

The IC-V80E offers a just-right mix of power and size. 5.5 watts of high power will work to get your message through.

19 Hours of Long Battery Life

Get up to 19 hours* of operating time with the BP-265 Li-ion battery pack or 13 hours with the BP-264 Ni-MH. All that power comes in an easy to hold and use size – not too big, not too small.

* Typical operation. 5:5:90 duty cycle with power save on.

IP54 and MIL-STD-810 Rugged Construction

The dust protection and water-resistance equivalent to IP54 provides reliable operation for practical outdoor operation. The IC-V80E tested to and passed 11 categories of MIL-STD-810 environmental tests.

A Total of 207 Memory Channels

The IC-V80E has a total of 207 memory channels, including 200 regular channels, 6 scan edges and 1 call channel. The channel name is programmable with 5 characters for easy recognition.

Built-in CTCSS/DTCS

The CTCSS and DTCS tone codes provide quiet stand-by and allow you to use tone-access repeaters. The pocket beep alerts you when a matching tone frequency is received. The tone scan detects the subaudible tone that is used for repeater access.

Internal VOX function

The IC-V80E has internal VOX (Voice Operated Transmit) function for convenient hands-free operation with a compatible optional headset and plug adapter cable. Also, the VOX gain and VOX delay time are adjustable.

Other Features

- Frequency coverage (TX/RX: 144–146 MHz)
- Program scan, memory scan, skip scan, priority scan and tone scan
- 1750 Hz tone for European repeater access
- TOT (time out timer) setting
- Repeater lockout and busy channel lockout
- PC programmable with optional CS-V80
- Transceiver-to-transceiver cloning (Optional)
- Direct keypad frequency entry
- DTMF autodial memories
- Auto power off
- Wide/narrow channel spacing

Mobile



VHF/UHF DUAL BAND TRANSCEIVER IC-2730E

50 Watts of Output Power on Both VHF and UHF Bands

VHF/VHF, UHF/UHF Simultaneous Receive

Optional Wireless Remote Control Bluetooth® Headset VS-3

VHF/VHF, UHF/UHF Simultaneous Receive

The IC-2730E provides VHF/VHF, UHF/UHF simultaneous receive capability, as well as VHF/UHF receive. A simple one-touch of a button enables you to change between the main (transmit) band and sub band.

Independent Controls for Each Band

Operating two bands simultaneously is very simple with the symmetric layout with a wide LCD display showing both band settings in an easy to read, side by side format. Various operations, including frequency tuning, is straight forward and smooth.

Optional VS-3 Bluetooth® Headset

The optional VS-3 Bluetooth® headset can wirelessly control the IC-2730E with three programmable keys and a PTT button. It also provides VOX operation for hands-free communication.

* Optional UT-133A Bluetooth® unit must be installed in the IC-2730E.

Easy Controller Mounting with the Optional MBF-1

The combination of the optional MBF-1 suction cup mounting base and MBA-5 controller bracket provides easy tilt and swivel adjustments. The large suction cup can be mounted on flat surfaces, and can be easily removed.

Other Features

- Controller attachment to the main unit with optional MBA-4
- 50 W of output on VHF/UHF
- Built-in CTCSS and DTCS tones with split tone functions
- Wide band receiver (118–174 and 375–550 MHz)*
- HM-207 remote control microphone
- CS-2730 Free download PC programming software
- Versatile scanning capability
- Squelch delay and squelch attenuator
- Sub band auto mute function
- Sub band busy beep function
- Auto power off
- 16 DTMF auto dial memories
- CI-V remote control capability (through the OPC-478UC)

* Receiver range differs, depending on the version.



Scan setting screen



Function menu for touch screen



Pop up menu appears by pushing DIAL B

COMMUNICATIONS RECEIVER IC-R8600

0.01-3000 MHz Super Wideband

Decode Digital Protocols (P25, NXDN™, dPMR™, D-STAR, DCR)

Real-Time Spectrum Scope with Waterfall

0.01-3000 MHz Super Wideband Coverage

The IC-R8600 decodes various digital protocol signals including P25 (Phase 1), NXDN™, dPMR™, D-STAR, Japanese DCR (Digital Convenience Radio). It also receives conventional analogue signals such as USB, LSB, FSK, CW, AM, S-AM (Synchronous-AM), FM and WFM modes, covering 10 kHz to 3 GHz wideband in 1 Hz steps.

Software Demodulation in FPGA Processing

The IC-R8600 utilizes FPGA (Field Programmable Gate Array) and DSP units for demodulation, decoding and most of signal processing. Direct HF signals and intermediate frequency signals, which are converted from VHF/UHF signals, are digitized in a 14-bit A/D converter and transferred to the FPGA and DSP for optimal processing. The high-rate 122.88 MHz sampling frequency used for the A/D converter results in superior aliasing and image reception reduction.



FPGA

Superb Receiver Performance

The IC-R8600 has 11 discrete RF bandpass filters in the HF bands and 13 bandpass filters in the VHF/UHF bands. To prevent overflow, only the intended signal is passed, while any out of range strong interference signals are rejected. The IC-R8600 provides +30 dBm IP3 and 105 dB dynamic range at 14.1 MHz. IP3 performance is +10 dBm at 144 MHz and 0 dBm at 440 MHz.

Variety of Scan Functions

A variety of scan functions effectively and thoroughly search for desired stations. The IC-R8600 scans up to 100 channels per second in the memory scan mode.

- Program scan/Fine program scan • Δ f scan/ Δ f fine scan • Priority scan • Memory scan
- Selected memory scan • Selected mode memory scan • Auto memory write scan

Real-time Spectrum Scope with Waterfall Function

The high-resolution real-time spectrum scope provides class-leading performance in resolution, maximum 30 frames per second* fast sweep speed, ± 2.5 MHz wide scope span (display range) and 110 dB of dynamic range (at ± 2.5 kHz span). The waterfall screen enables you to find weak signals by showing the spectrum change over time.

(* Approximate)

Quick, Smooth and Intuitive Operation

To efficiently acquire intended signals, the IC-R8600 user interface provides quick and accurate operation. The large 4.3-inch colour display, with touch screen function, is configured to collect operating information. By tapping indications and icons on the screen, the setting menu will pop up and parameters can easily be adjusted.

SD Card Slot for Receiver Recorder

The recorder function can record received audio onto an SD card in WAVE format. The recorded voice audio can be played back on the receiver or a PC. When a 32 GB SD card is used, up to 270 hours of recording is possible. In addition, the screen capture function saves a snap shot of the screen in PNG or BMP format on the SD card.

* An SD card is required.

I/Q Signal Output

The I/Q signal output function* enables you to derive digital IF signals from the I/Q output port to a PC through a USB cable. It can be used for analyzing spectrum or decoding signals. The IC-R8600 outputs I/Q data to the third-party software HSDR, and the IC-R8600 can be controlled by the HSDR.

* This function requires firmware version 1.3 or later. Download the IC-R8600 USB I/Q package for HSDR.

Other Features

- Absolute Value of RSSI (Received Signal Strength Indicator)
- 2000 regular Memory channels
- Remote control function through IP network or USB cable
- 3 antenna connectors: an SO-239 type and a phono (RCA) connector for HF and a type-N connector
- Clock and NTP function
- Center tuning meter and digital auto frequency control (AFC) for FM, WFM and digital modes
- Built-in Voice synthesizer
- Audio tone functions: HPF/LPF, bass, treble and de-emphasis
- Decode multiple digital code used in digital mode
- IP+ function improves 3rd order intercept point performance
- Main dial friction adjustment
- Dial lock and panel lock
- CI-V remote control command
- RX history log for digital modes



Rugged
MIL-STD 810



COMMUNICATIONS RECEIVER IC-R30

Dualwatch and Dual Recording

Decode Digital Protocols
(P25, NXDN™, dPMR™, D-STAR, DCR)

0.1 – 3304.999 MHz
Wideband Coverage

Dualwatch and Dual Recording

The IC-R30 can receive on different bands and different modes. The audio of the two bands received while in the Dualwatch mode, can be individually recorded onto a microSD card* in the WAV format. The recorded audio can be played back on the receiver or a PC.

* A microSD/microSDHC card is required.

Decodes Digital Protocols

The IC-R30 decodes various digital protocol signals including P25 (Phase 1), NXDN™, dPMR™, D-STAR and Japanese domestic DCR (Digital Convenience Radio).

0.1-3304.999 MHz Wideband Coverage

The IC-R30 covers a wide frequency range from 0.1 to 3304.999 MHz, and receives conventional analogue signals such as AM, FM, WFM, USB, LSB and CW as well as digital mode signals*.

* SSB, CW and digital modes: 0.1 MHz–1.3 GHz.

Wireless Operation with a Bluetooth® Headset

With the optional VS-3 Bluetooth® headset, you can wirelessly listen to received audio. The VS-3 has volume UP/DOWN buttons and four programmable buttons to remotely control certain functions.

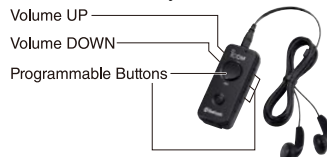

Bluetooth® headset, VS-3 (option)

Top Level Scan Speed – 200 Channels/Second

The IC-R30 scans approximately 200 channels per second in the A band. You can quickly find and lock in to a desired signal. The IC-R30 has variety of scan functions; VFO scan (Auto memory write scan, Program scan), Memory scan (Near station scan, Mode scan, Group scan, Group link scan), Priority scan, Tone scan and more.

Other Features

- Integrated GPS receiver
- 2.3" large LCD and intuitive user interface
- Band scope function
- Speech function
- IP57 dust-protection and waterproof protection
- Up to 8.3 hours of long battery life*
- USB charging and PC connection
- Optional BP-293 AA (LR6) × 3 battery case
- microSD card slot
- 2000 regular Memory channels
- Earphone cord antenna for AM aviation as well as FM broadcast
- Ferrite bar antenna for AM broadcast
- DTCS and CTCSS tone squelch and reverse tone squelch
- Optional CS-R30 programming software
- VSC (Voice Squelch Control) (FM, FM-N, WFM, AM, AM-N)
- AFC (Auto Frequency Control) (FM, FM-N, WFM)
- Noise blanker (SSB, CW)
- ANL (Auto Noise Limiter) (AM, AM-N)
- RF gain control (10 steps)
- ATT function (3 steps)
- Key lock function
- Monitor function
- Power save function (3 steps)
- Volume or frequency setting with dial or side buttons
- Clock

* The Dualwatch function is ON (A band: continuously receiving, B band: standing by), the Power Save function is set to "Auto (Short)," the internal speaker's volume is set to "20," the GPS function is ON, and the Bluetooth® function is OFF.



COMMUNICATIONS RECEIVER IC-R6

0.1-1309.995 MHz
Wideband Coverage

100 Channels Per Second
High Speed Scan

15 Hours of Continuous
Receive Capability

0.1-1309.995 MHz* Coverage

Amateur stations, AM, FM, short wave broadcasts, air band, marine VHF, PMR446 and a variety of utility communications can be found and listened to.

100 Channels per Second High Speed Scan

The IC-R6 has 100 channels per second high speed scan capability* and variety of scan functions; Auto memory scan, Tone scan, Programmed scan, Memory scan, priority scan, auto memory write scan and more.

* VFO mode scanning.

15 Hours of Continuous Receive Capability*

The IC-R6 is energy-efficient, designed to provide many hours of listening enjoyment on a single charge. With the supplied rechargeable Ni-MH cells (1400 mAh ×2), the IC-R6 provides up to 15 hours of continuous receive capability*.

* At 50 mW output using external speaker.

1300 Memory Channels with 22 Memory Banks

With 1300 alphanumeric Memory channels, 50 scan edges and 200 auto write memories, the IC-R6 gives you flexible scanning. Use the bank link scan feature to choose from and connect any of the 22 memory banks.

VSC (Voice Squelch Control)

The VSC opens the squelch only when a modulated signal is detected, and ignores unmodulated beat noise. It is a handy feature for those listeners who are scanning for talk, news and music, but not data bursts or beacons.

Other Features

- Built-in audio low pass filter
- ±1.0 ppm high frequency stability (at 25°C)
- Earphone cord antenna for AM aviation as well as FM broadcast
- Ferrite bar antenna for AM broadcast
- DTCS and CTCSS tone squelch and reverse tone squelch
- Optional CS-R6 programming software
- Receiver-to-receiver cloning (optional OPC-474 required)
- Auto power OFF
- Compact, drip-resistant construction
- Duplex operation monitoring
- Automatic LCD backlight
- Dial speed acceleration
- Built-in RF attenuator
- Reversible up/down buttons and dial knob for volume, frequency, memory channel, scan direction and set mode settings
- Optional tube earphone, SP-27

OPTIONS FOR BASE STATION TRANSCEIVERS AND RECEIVERS









MODEL NAME	HAND MICROPHONES					DESKTOP MICROPHONES			EXTERNAL SPEAKERS
	HM-36	HM-219	HM-103	HM-151	HM-198	SM-50	SM-30	SM-27	SP-23 4 audio filters
IC-7851	✓					✓	✓		
IC-7610	✓	✓				✓	✓		✓
IC-7700	✓	✓				✓	✓		
IC-7300	✓	✓				✓	✓		✓
IC-718	✓	✓				✓	✓	✓	✓
IC-7100	(Use with OPC-589)	(Use with OPC-589)	✓	✓	✓	(Use with OPC-589)	(Use with OPC-589)		
IC-9100	✓	✓				✓	✓		✓
IC-R8600									✓





MODEL NAME	EXTERNAL SPEAKERS						DC POWER SUPPLY	AC ADAPTER	ANTENNA ELEMENT
	SP-33 Wooden box speaker	SP-34 4 audio filters	SP-35 2 m cable SP-35L 6 m cable	SP-38 Best design matched for the IC-7300	SP-39AD With DC power supply	SP-41 With two input lines best design match for the IC-7610	PS-126 13.8 V/25 A 4-pin type	AD-55NS Input: 100–240 V/1 A, Output: 15V/2A	AH-2b Covers 7–54 MHz for use with AH-4
IC-7851	✓	✓							
IC-7610	✓	✓	(Use SP-35L)			✓			✓
IC-7700	✓	✓				✓			
IC-7300	✓	✓	✓	✓		✓			✓
IC-718						✓	(Depending on version)		✓
IC-7100			(Use SP-35)			✓	✓		✓
IC-9100						✓	✓		✓
IC-R8600					✓	✓		✓	

MODEL NAME	ANTENNA TUNERS	AUTO TUNING ANTENNA	NVIS KIT	CONTROL CABLE	FOLDED DIPOLE ANTENNA	OMNIDIRECTIONAL ANTENNA	FILTERS		
	AH-4 Covers 3.5–54 MHz	AT-180 Covers 1.8–54 MHz. (amateur band except 5 MHz)	AH-740 Covers 2.5–30 MHz. (amateur band) OPC-2321 is required.	AH-5NV Fiberglass antenna element for use with AH-740. Covers 2.2–30MHz (amateur band) with AH-740.	OPC-2321 (6m) For use with AH-740 OPC-420 (10m) For use with AH-4.	AH-710 Covers 1.9–30 MHz Approx. 24.5 m (80.5 ft) 30 m, 98.4 ft	AH-8000 Covers 100–3335 MHz	FL-430 6 kHz 1st IF filter (For HF/ 50 MHz band)	FL-431 3 kHz 1st IF filter (For HF/50 MHz band)
IC-7851									
IC-7610	✓		(Use with OPC-2321)	✓	✓	✓			
IC-7700									
IC-7300	✓		(Use with OPC-2321)	✓	✓	✓			
IC-718	✓	✓	(Use with OPC-2321)	✓	✓	✓			
IC-7100	✓	✓	(Use with OPC-2321)	✓	✓	✓			
IC-9100	✓		(Use with OPC-2321)	✓	✓		✓		✓
IC-R8600						✓	✓		





: Applicable
 : Not applicable

OPTIONS FOR BASE STATION TRANSCEIVERS AND RECEIVERS

MODEL NAME	FILTERS	HIGH STABILITY CRYSTAL UNIT	DSP UNIT	LINEAR AMPLIFIER	CARRYING HANDLES	MOBILE MOUNTING BRACKETS	MOUNTING BASE	CONTROLLER BRACKET
	FL-53A 250 Hz/−6 dB FL-257 3.3 kHz/−6 dB	CR-338 Frequency stability: ±0.5 ppm	UT-106	IC-PW1EURO	MB-23 MB-121 MB-123	MB-62 MB-118	MBF-1	MBA-1
					 (Photo shows MB-23)			
IC-7851				✓				
IC-7610				✓	(Use MB-121)			
IC-7700				✓				
IC-7300				✓ (Use with OPC-599)	✓ (Use MB-123)			
IC-718	✓ (Accepts only one filter)	✓	✓ (Installed depending on version)	✓ (Use with OPC-599)	✓ (Use MB-23)	✓		
IC-7100				✓ (Use with OPC-599)		✓		
IC-9100				✓ (Use with OPC-599)	✓ (Use MB-123)		✓ (Use with MBA-1)	✓
IC-R8600					✓ (Use MB-123)			

MODEL NAME	SEPARATION CABLES	MIC ADAPTER CABLE	ADAPTER CABLE	DC POWER CABLES	PROGRAMMING SOFTWARE	REMOTE CONTROL SOFTWARE
	OPC-2253 3.5 m OPC-2254 5.0 m	OPC-589 8-pin connector microphone to 8-pin modular	OPC-599 13-pin ACC socket to 7-, 8-pin ACC sockets	OPC-025A 20 A cable OPC-1457R 30 A cable OPC-2095 30 A cable	CS-9100 A USB cable (A-B type) is required for programming. CS-7100 CS-R8600	RS-MS1A *1 RS-R8600
						 
IC-7851						
IC-7610				✓ (Use OPC-2095)		
IC-7700						
IC-7300			✓	✓ (Use OPC-1457R)		
IC-718			✓	✓ (Use OPC-025A)		
IC-7100	✓	✓	✓	✓ (Use OPC-2095)	✓	✓ (Use with OPC-2350LU)
IC-9100			✓	✓ (Use OPC-2095)	✓	
IC-R8600						✓









*1 Free download Android™ app. Download from Google Play™.









MODEL NAME	IP REMOTE CONTROL SOFTWARE	USB REMOTE ENCODER	DIGITAL UNIT	DATA COMMUNICATION CABLES
	RS-BA1	RC-28	UT-121	OPC-1529R RS-232 cable for an external GPS or a PC OPC-2350LU USB cable for an Android™ device or a PC
				 
IC-7851	✓	✓*2		
IC-7610	✓	✓		
IC-7700	✓	✓ (Use with RS-BA1)		
IC-7300	✓	✓ (Use with RS-BA1)		
IC-718				
IC-7100	✓	✓ (Use with RS-BA1)		✓
IC-9100	✓	✓ (Use with RS-BA1)	✓	✓
IC-R8600		✓ (Use with RS-R8600)		

*2 This function requires firmware version 1.2 or later.









☑ : Applicable ☐ : Not applicable

OPTIONS FOR HANDHELD TRANSCEIVERS AND RECEIVERS

MODEL NAME	BATTERY CASES			BATTERY PACKS					DESKTOP CHARGERS
	BP-273 LR6(AA)×3 cells 	BP-263 LR6(AA)×3 cells 	BP-293 LR6(AA)×3 cells 	BP-271 (Li-ion) 7.4V/ 1150 mAh (min.), 1200 mAh (typ.) 	BP-272 (Li-ion) 7.4 V/ 1880 mAh (min.), 2000 mAh (typ.) 	BP-264 (Ni-MH) 7.2 V/1400 mAh 	BP-265 (Li-ion) 7.4 V/ 1850 mAh (min.), 2000 mAh (typ.) 	BP-287 (Li-ion) 3.6 V/ 3120 mAh (min.), 3280 mAh (typ.) 	BC-202 Rapid charger 
ID-51E <small>PLUS2</small>	✓			✓	✓				✓ (Use with BC-123SE)
ID-31E PLUS	✓			✓	✓				✓ (Use with BC-123SE)
IC-V80E		✓				✓	✓		
IC-R30			✓					✓	
IC-R6									

MODEL NAME	DESKTOP CHARGERS					MULTI-CHARGER	AC ADAPTERS		
	BC-191 Rapid charger, Charges the BP-264 in 2 hours (approx.) 	BC-192 Charges the BP-264 in 16 hours (approx.) 	BC-193 Rapid charger, Charges the BP-265 in 2.5 hours (approx.) 	BC-194 	BC-223 Rapid charger 	BC-197* For use with BP-264/265 	BC-123SE 12 V/1 A 	BC-147SE 12 V/0.25 A 	BC-157S 12 V/7.5 A 
ID-51E <small>PLUS2</small>							✓ (Use with BC-202)		
ID-31E PLUS							✓ (Use with BC-202)		
IC-V80E	✓ (Use with BC-123SE)	✓ (Use with BC-147/206SE)	✓ (Use with BC-123SE)			✓ (Use with BC-157S)	✓ (Use with BC-191/193)	✓ (Use with BC-192)	✓ (Use with BC-197)
IC-R30					✓ (Use with BC-123SE)		✓ (Use with BC-223)		
IC-R6				✓ (Use with BC-153SE)					

* Either AD-120 (for BP-264) or AD-121 (for BP-265) charger adapters are supplied with the BC-197, depending on BC-197's version.

MODEL NAME	AC ADAPTERS		WALL CHARGER	CIGARETTE LIGHTER CABLES		DC POWER CABLES			SPEAKER-MICROPHONES
	BC-206SE 15 V/0.4 A 	BC-153SE 6 V/1 A 	BC-167SD 12 V/500 mA 	CP-12L with noise filter 	CP-23L 	OPC-254L 	OPC-515L 	OPC-656 	HM-75LS 
ID-51E <small>PLUS2</small>			✓	✓		✓			✓
ID-31E PLUS			✓	✓		✓			✓
IC-V80E	✓ (Use with BC-192)				✓ (Use with BC-191/193)		✓ (Use with BC-191/192/193)	✓ (Use with BC-197)	
IC-R30									
IC-R6		✓ (Use with BC-194)							

MODEL NAME	SPEAKER-MICROPHONES				EARPHONE-MICROPHONES			HEADSETS	
	HM-183LS Waterproof 	HM-186LS 	HM-158LA 	HM-159LA 	HM-153LS 	HM-153LA 	HM-166LS 	HS-94 Earhook type with boom microphone 	HS-95 Behind-the-head type 
ID-51E <small>PLUS2</small>	✓	✓			✓		✓	✓ (Use with OPC-2006LS)	✓ (Use with OPC-2006LS)
ID-31E PLUS	✓	✓			✓		✓	✓ (Use with OPC-2006LS)	✓ (Use with OPC-2006LS)
IC-V80E			✓	✓		✓		✓ (Use with OPC-2004)	✓ (Use with OPC-2004)
IC-R30									
IC-R6									

✓ : Applicable □ : Not applicable

OPTIONS FOR HANDHELD TRANSCEIVERS AND RECEIVERS

	HEADSETS	EARPHONES		PLUG ADAPTER CABLES			Bluetooth® HEADSET	CARRYING CASES	
MODEL NAME	HS-97 Throat microphone type	SP-40	SP-27	OPC-2006LS	OPC-2144	OPC-2004	VS-3	LC-179	LC-178
ID-51E (PLUS2)	(Use with OPC-2006LS)			✓	✓			✓	
ID-31E PLUS	(Use with OPC-2006LS)	(Use with OPC-2144)		✓	✓				✓
IC-V80E	(Use with OPC-2004)					✓			
IC-R30		✓					✓		
IC-R6		✓	✓						

	CARRYING CASES	SILICONE JACKET CASE	CHARGER BRACKET	DATA CABLE	PROGRAMMING CABLES			BELT CLIPS	
MODEL NAME	LC-189	LC-146A	SJ-1 For use with BP-271	MB-130	OPC-2350LU USB cable for an Android™ device or a PC	OPC-474 Handheld to handheld	OPC-478 Handheld to PC RS-232C cable	OPC-478UC Handheld to PC USB cable	MB-127 Alligator type
ID-51E (PLUS2)			✓		✓				✓
ID-31E PLUS					✓				✓
IC-V80E				(Use with BC-191/192/193)		✓	✓	✓	
IC-R30	✓								
IC-R6		✓				✓	✓	✓	

	BELT CLIPS		ANTENNAS	ANTENNA ADAPTER	PROGRAMMING SOFTWARE	REMOTE CONTROL APP	TERMINAL/ACCESS POINT MODE APP/SOFTWARE
MODEL NAME	MB-124	MB-133	FA-S270C FA-S70B FA-B2E	AD-925MA BNC type antenna connector	CS-51 PLUS2*1 CS-31PLUS*1 CS-V80 CS-R30 CS-R6	RS-MS1A*2 For Android™ device	RS-MS3A*2 For Android™ device RS-MS3W*3 For Windows® PC (Photo shows RS-MS3A)
ID-51E (PLUS2)			(Use FA-S270C)	✓	(Use CS-51 PLUS2)	(Use with OPC-2350LU)	(Use with OPC-2350LU)
ID-31E PLUS			(Use FA-S70B)	✓	(Use CS-31PLUS)	(Use with OPC-2350LU)	(Use with OPC-2350LU)
IC-V80E	✓		(Use FA-B2E)		(Use CS-V80)		
IC-R30		✓		✓	(Use CS-R30)		
IC-R6				✓	(Use CS-R6)		

*1 CS-51 PLUS2 and CS-31PLUS are available for free download from: <http://www.icom.co.jp/world/support/index.html>

*2 Free download Android™ app. Download from Google Play™.

*3 Free download software for Windows® PC. Download from the Icom website: <http://www.icom.co.jp/world/support/download/firm/>

Note for the Terminal mode and Access point mode:

- Before operating in the Terminal mode or the Access Point mode, BE SURE to check your local regulations or laws.
- An optional free download software, RS-MS3W is required to be installed in a PC. An optional free download application, RS-MS3A is required to be installed in the Android™ device.
- You need an Internet connection with an IPv4 Global IP address. If you use a cellular system, you need an IPv4 Global IP address assigned to your Windows® or Android™ device.
- When operating in the Access Point mode, you need two call signs. One for the Access Point transceiver and one for the Remote D-STAR transceiver.
- For the Access point or Terminal mode operation, please register your MY and Access point call signs with a Gateway repeater/server that has the RS-RP3C installed.

: Applicable : Not applicable

OPTIONS FOR MOBILE TRANSCEIVERS

MODEL NAME	HAND MICROPHONES					BLUETOOTH® HEADSET	MOUNTING BASE	MOUNTING BRACKET	CONTROLLER BRACKET
	HM-198	HM-209 Noise canceling microphone	HM-207 HM-207S	HM-154	HM-232	VS-3	MBF-1	MBF-4	MBA-2
ID-5100E	✓	✓	(Use HM-207)	✓	✓	✓ (Use with UT-133A)	✓ (Use with MBA-2)	✓	✓
ID-4100E	✓	✓	(Use HM-207S)	✓	✓	✓ (Use with UT-137)	✓ (Use with MBA-8)	✓	
IC-2730E	✓	✓	(Use HM-207)	✓	✓	✓ (Use with UT-133A)	✓ (Use with MBA-5)	✓	

MODEL NAME	CONTROLLER BRACKETS	COMBINATION BRACKET	EXTERNAL SPEAKERS		MICROPHONE CABLES	MIC ADAPTER CABLE	CONTROLLER CABLE	DATA CABLE
	MBA-8	MBA-5	MBA-4	SP-35 2 m cable SP-35L 6 m cable	SP-30 4 inch (102.5 mm) diameter speaker	OPC-440A 5.0 m OPC-647 2.5 m	OPC-589 8-pin connector microphone to 8-pin modular	OPC-1156 3.5 m
ID-5100E				✓	✓	✓	✓	✓
ID-4100E	✓			✓	✓	✓	✓	✓
IC-2730E		✓	✓	✓	✓	✓	✓	✓

MODEL NAME	DATA CABLES	PROGRAMMING CABLES	CLONING CABLE	BLUETOOTH® UNITS		PROGRAMMING SOFTWARES	TERMINAL/ACCESS POINT MODE APP/SOFTWARE	REMOTE CONTROL APP
	OPC-2350LU USB cable for an Android™ or a PC	OPC-478UC Transceiver to PC USB cable	OPC-474 Between transceivers	UT-133A	UT-137	CS-5100* ¹ CS-4100* ¹ CS-2730* ¹	RS-MS3A* ² For Android™ device	RS-MS3W* ³ For Windows® PC
ID-5100E	✓	✓		✓		✓ (Use CS-5100)		✓ (Use with UT-133A)
ID-4100E	✓	✓			✓	✓ (Use CS-4100)	✓ (Use with OPC-2350LU)	✓ (Use with UT-137)
IC-2730E		✓	✓	✓		✓ (Use CS-2730)	✓ (Use with OPC-2350LU)	

*1 CS-5100, CS-4100 and CS-2730 are available for free download from Icom website:
<http://www.icom.co.jp/world/support/index.html>

*2 Free download Android™ app. Download from Google Play™.

*3 Free download software for Windows® PC. Download from the Icom website:
<http://www.icom.co.jp/world/support/download/firm/>

Note for the Terminal mode and Access point mode:

• Before operating in the Terminal mode or the Access Point mode, BE SURE to check your local regulations or laws. • An optional free download software, RS-MS3W is required to be installed in a PC. An optional free download application, RS-MS3A is required to be installed in the Android™ device. • You need an Internet connection with an IPv4 Global IP address. If you use a cellular system, you need an IPv4 Global IP address assigned to your Windows® or Android™ device. • When operating in the Access Point mode, you need two call signs. One for the Access Point transceiver and one for the Remote D-STAR transceiver. • For the Access point or Terminal mode operation, please register your MY and Access point call signs with a Gateway repeater/server that has the RS-RP3C installed.

MODEL NAME	REMOTE CONTROL APP
	ID-5100E
ID-4100E	✓ (Use with UT-137)
IC-2730E	

*4 Free download iOS™ app. Download from the App Store.

RS-MS1A/RS-MS1I Remote Control App

(Free Download Android™/iOS™ Application from Google Play™/App Store)

The RS-MS1A and RS-MS1I allow you to connect the Digital transceiver with an Android™/iOS™ device and remotely control various functions and settings from the Android™/iOS™ device. You can take pictures with your iOS™ or Android™ device, or use stored pictures, and share them over the DV mode.

* An optional Bluetooth® unit (UT-133A or UT-137) or a data cable (OPC-2350LU) is required. Not all functions are usable with the IC-7100.

* Some functions may not work properly, depending on Android™/iOS™ phones and devices used.

* Photo shows RS-MS1A.

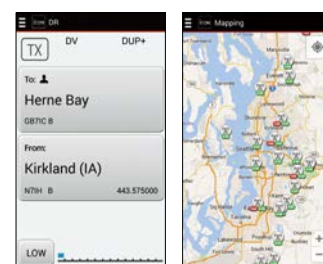

DR function setting example

Repeater map example © Google

✓ : Applicable □ : Not applicable

SPECIFICATIONS FOR BASE STATION TRANSCEIVERS

		IC-7851	IC-7610	IC-7700	IC-7300
General	Frequency coverage <small>(Differs according to version)</small>	Tx: 135 kHz, 1.8, 3.5, 7, 10, 14, 18, 21, 24, 28, 50MHz bands Rx: 30 kHz–60 MHz* * Some frequency ranges are not guaranteed.	Tx: 135 kHz, 1.8, 3.5, 7, 10, 14, 18, 21, 24, 28, 50MHz bands Rx: 30 kHz–60 MHz* * Some frequency ranges are not guaranteed.	Tx: 1.8, 3.5, 7, 10, 14, 18, 21, 24, 28, 50 MHz bands Rx: 30 kHz–60 MHz* * Some frequency ranges are not guaranteed.	Tx: 1.8, 3.5, 7, 10, 14, 18, 21, 24, 28, 50, 70 ¹ MHz bands Rx: 30 kHz–74.8 MHz ² ¹ Depending on version. ² Some frequency ranges are not guaranteed.
	Modes	USB, LSB, CW, RTTY, PSK31/63, AM, FM	USB, LSB, CW, RTTY, PSK31/63, AM, FM	USB, LSB, CW, RTTY, PSK31, AM, FM	USB, LSB, CW, RTTY, AM, FM
	Frequency stability	Less than ±0.05 ppm (0°C to +50°C; @ 54 MHz, after warm up)	Less than ±0.5 ppm (0°C to +50°C)	±0.05 ppm (0°C to +50°C, after warm up)	Less than ±0.5 ppm (–10°C to +60°C)
	Maximum current drain	800 VA (85–265 V AC)	23 A at 13.8 V DC	800 VA (85–265 V AC)	21 A at 13.8 V DC
	Antenna connector	SO-239 × 4 + BNC × 2 (50 Ω)	SO-239 × 2 + BNC (50 Ω)	SO-239 × 4 + BNC (50 Ω)	SO-239 (50 Ω)
	Dimensions <small>(W × H × D; Projections are not included)</small>	425 × 149 × 435 mm	340 × 118 × 277 mm	425 × 149 × 437 mm	240 × 94 × 238 mm
	Weight (approx.)	23.5 kg	8.5 kg	22.5 kg	4.2 kg
Transmitter	Output power	SSB, CW, RTTY, PSK, FM: 5–200 W AM: 5–50 W Transverter connector (CW): More than –20 dBm	SSB, CW, RTTY, PSK, FM: 1–100 W AM: 1–25 W Transverter connector (CW): More than –20 dBm	SSB, CW, RTTY, PSK31, FM: 5–200 W AM: 5–50 W	SSB, CW, FM, RTTY: HF/50 MHz 2–100 W 70 MHz 2–50 W AM: HF/50 MHz 1–25 W 70 MHz 1–12.5 W
	Sensitivity (typical) <small>Preamp ON SSB, CW, RTTY, AM: at 10 dB S/N FM, WFM: at 12 dB SINAD</small>	SSB, CW, RTTY, PSK (2.4 kHz): 0.1–1.799 MHz 0.5 μV 1.8–29.999 MHz 0.16 μV 50–54 MHz 0.13 μV AM (6 kHz): 0.1–1.799 MHz 6.3 μV 1.8–29.999 MHz 2.0 μV 50–54 MHz 1.0 μV FM (15 kHz): 28–29.700 MHz 0.5 μV 50–54 MHz 0.32 μV	SSB, CW (2.4 kHz): 1.8–29.999 MHz 0.16 μV 50–54 MHz 0.13 μV AM (6 kHz): 0.5–1.799 MHz 6.3 μV 1.8–29.999 MHz 2.0 μV 50–54 MHz 1.0 μV FM (15 kHz): 28–29.7 MHz 0.5 μV 50–54 MHz 0.32 μV	SSB, CW, RTTY (2.4 kHz): 0.1–1.799 MHz 0.5 μV 1.8–29.990 MHz 0.16 μV 50–54 MHz 0.13 μV AM (6 kHz): 0.1–1.799 MHz 6.3 μV 1.8–29.990 MHz 2.0 μV 50–54 MHz 1.0 μV FM (15 kHz): 28–29.999 MHz 0.5 μV 50–54 MHz 0.32 μV	SSB, CW (2.4 kHz): 1.8–29.999 MHz 0.16 μV 50–54 MHz 0.13 μV 70–70.5 MHz 0.16 μV AM (6 kHz): 0.5–1.8 MHz 12.6 μV 1.8–29.999 Hz 2.0 μV 50–54 MHz 1.0 μV 70–70.5 MHz 1.0 μV FM (15 kHz): 28–29.7 MHz 0.5 μV 50–54 MHz 0.25 μV 70–70.5 MHz 0.25 μV
Receiver	Sensitivity for RED (Less than) <small>Preamp ON SSB, AM, FM: at 12 dB SINAD</small>	SSB (2.4 kHz): 1.8–2.999 MHz 10 dBμV emf 3.0–29.999 MHz 0 dBμV emf 50 MHz band –6 dBμV emf AM (4 kHz, 60% modulation): 1.8–2.999 MHz 16 dBμV emf 3.0–29.999 MHz 6 dBμV emf 50 MHz band 0 dBμV emf FM (7 kHz, 60% modulation): 28–29.700 MHz 0 dBμV emf 50 MHz band –6 dBμV emf	SSB (2.4 kHz): 1.8–2.999 MHz 10 dBμV emf 3.0–29.999 MHz 0 dBμV emf 50 MHz band –6 dBμV emf AM (4 kHz, 60% modulation): 1.8–2.999 MHz 16 dBμV emf 3.0–29.999 MHz 6 dBμV emf 50 MHz band 0 dBμV emf FM (7 kHz, 60% modulation): 28–29.700 MHz 0 dBμV emf 50 MHz band –6 dBμV emf	SSB (2.4 kHz): 1.8–2.999 MHz 10 dBμV emf 3.0–29.990 MHz 0 dBμV emf 50 MHz band –6 dBμV emf AM (4 kHz, 60% modulation): 1.8–2.999 MHz 16 dBμV emf 3.0–29.990 MHz 6 dBμV emf 50 MHz band 0 dBμV emf FM (7 kHz, 60% modulation): 28–29.990 MHz 0 dBμV emf 50 MHz band –6 dBμV emf	SSB (2.4 kHz): 1.8–2.999 MHz 10 dBμV emf 3.0–29.999 MHz 0 dBμV emf 50/70 MHz band –6 dBμV emf AM (4 kHz, 60% modulation): 1.8–2.999 MHz 16 dBμV emf 3.0–29.999 MHz 6 dBμV emf 50/70 MHz band 0 dBμV emf FM (7 kHz, 60% modulation): 28–29.700 MHz 0 dBμV emf 50/70 MHz band –6 dBμV emf
	Selectivity	SSB: 2.4 kHz/–3 dB (2.4 kHz) 3.6 kHz/–60 dB CW/RTTY/PSK: 500 Hz/–3 dB (500 Hz) 700 Hz/–60 dB AM: 6.0 kHz/–3 dB (6 kHz) 15 kHz/–60 dB FM: 12 kHz/–6 dB (15 kHz) 20 kHz/–60 dB * Variable between 50 Hz and 3.6 kHz.	SSB: 2.4 kHz/–6 dB (2.4 kHz) 3.6 kHz/–60 dB CW: 500 Hz/–6 dB (500 Hz) 700 Hz/–60 dB RTTY: 500 Hz/–6 dB (500 Hz) 700 Hz/–60 dB AM: 6.0 kHz/–6 dB (6 kHz) 15 kHz/–60 dB FM: 12 kHz/–6 dB (15 kHz) 20 kHz/–60 dB * Variable between 50 Hz and 3.6 kHz.	SSB: 2.4 kHz/–3 dB (2.4 kHz) 3.6 kHz/–60 dB CW: 500 Hz/–3 dB (500 Hz) 700 Hz/–60 dB RTTY, PSK31: 360 Hz/–6 dB (350 Hz) 650 Hz/–60 dB AM: 6.0 kHz/–3 dB (6 kHz) 15 kHz/–60 dB FM: 12 kHz/–6 dB (15 kHz) 20 kHz/–60 dB * Variable between 50 Hz and 3.6 kHz.	SSB: 2.4 kHz/–6 dB (2.4 kHz) 3.4 kHz/–40 dB CW: 500 Hz/–6 dB (500 Hz) 700 Hz/–40 dB RTTY: 500 Hz/–6 dB (500 Hz) 800 Hz/–40 dB AM: 6.0 kHz/–6 dB (6 kHz) 10 kHz/–40 dB FM: 12 kHz/–6 dB (15 kHz) 22 kHz/–40 dB * Variable between 50 Hz and 3.6 kHz.
	Spurious and image rejection	More than 70 dB	HF More than 70 dB 50 MHz More than 70 dB* * Except for ADC Aliasing	More than 70 dB	HF More than 70 dB 50/70 MHz More than 70 dB* * Except for ADC Aliasing
	Audio output power <small>(at 10% distortion with an 8 Ω load)</small>	More than 2.6 W	More than 2.0 W	More than 2.6 W	More than 2.5 W

The LCD display may have cosmetic imperfections that appear as small or dark spots. This is not a malfunction or defect, but a normal characteristic of LCD displays.
All stated specifications are subject to change without notice or obligation.

SPECIFICATIONS FOR BASE STATION TRANSCEIVERS

		IC-718	IC-7100	IC-9100
General	Frequency coverage <small>(Differs according to version)</small>	Tx: 1.8, 3.5, 7, 10, 14, 18, 21, 24, 28 MHz bands Rx: 30 kHz–29.999 MHz* * Guaranteed range 0.5–29.999 MHz.	Tx: 1.8, 3.5, 7, 10, 14, 18, 21, 24, 28, 50, 70*1, 144, 430 MHz bands Rx: 30 kHz–199.999 MHz, 400–470 MHz*2 *1 Depending on version. *2 Some frequency ranges are not guaranteed	Tx: 1.8, 3.5, 7, 10, 14, 18, 21, 24, 28, 50, 144, 430 MHz bands Rx: 30 kHz–60 MHz*, 144–146 MHz, 430–440 MHz * Some frequency ranges are not guaranteed.
	Modes	USB, LSB, CW, RTTY, AM	USB, LSB, CW, RTTY, DV, AM, FM, WFM* (*Rx only)	USB, LSB, CW, RTTY (FSK), AM*, FM, DV (with UT-121) * Transmit HF/50 MHz only.
	Frequency stability	Less than ±200 Hz <small>(From 1 min. to 60 min. after power ON)</small>	±0.5 ppm <small>(0°C to +50°C @ 430 MHz)</small>	±0.5 ppm <small>(0°C to +50°C, after warm up)</small>
	Maximum current drain	20 A at 13.8 V DC	22 A (HF/50/70 MHz), 16 A (144/430 MHz) at 13.8 V DC	24 A at 13.8 V DC
	Antenna connector	SO-239 (50 Ω)	SO-239 × 2 (for HF/50/70 MHz and 144/430 MHz bands: 50 Ω)	HF/50 MHz SO-239 (50 Ω) × 2 144 MHz SO-239 (50 Ω) 430 MHz Type-N (50 Ω)
	Dimensions <small>(W × H × D. Projections are not included)</small>	240 × 95 × 239 mm	Main unit: 167 × 58 × 225 mm Controller: 165 × 64 × 78.5 mm	315 × 116 × 343 mm
	Weight <small>(approx.)</small>	3.8 kg	Main unit: 2.3 kg Controller: 500 g	11 kg
Transmitter	Output power	SSB, CW, RTTY, FM: 2–100 W AM: 2–35 W	SSB, CW, RTTY, FM, DV: 1.8–50 MHz 2–100 W 70/144 MHz 2–50 W 430 MHz 2–35 W AM: 1.8–50 MHz 1–30 W 70 MHz 1–15 W	SSB, CW, RTTY, FM, DV*: HF/50 MHz 2–100 W 144 MHz 2–100 W 430 MHz 2–75 W AM: HF/50 MHz 2–30 W * With UT-121.
	Sensitivity <small>(typical)</small> <small>Preamp ON SSB, CW, RTTY, AM: at 10 dB S/N FM, WFM: at 12 dB SINAD DV: at 1% BER</small>	SSB, CW: 1.8–29.999 MHz 0.16 µV AM: 0.5–1.799 MHz 13 µV 1.8–29.999 MHz 2.0 µV	SSB, CW (2.4 kHz): 1.8–29.995 MHz 0.15 µV 50–54 MHz 0.12 µV 70–70.5 MHz 0.15 µV 144/430 MHz 0.11 µV AM: 0.5–1.8 MHz 13 µV (6 kHz) 1.8–29.995 MHz 2.0 µV 50/70/144/430 MHz 1.0 µV FM: 28–29.7 MHz 0.5 µV (15 kHz) 50/70 MHz 0.25 µV 144/430 MHz 0.18 µV DV: 28–29.7 MHz 1 µV 50/70 MHz 0.63 µV 144/430 MHz 0.35 µV WFM: 76–108 MHz 10 µV	SSB, CW (2.4 kHz): 1.8–29.999 MHz 0.16 µV 50–54 MHz 0.13 µV 144/430 MHz 0.11 µV AM: 0.5–1.8 MHz 12.6 µV (6 kHz) 1.8–29.999 MHz 2.0 µV 50–54 MHz 1.6 µV 144/430 MHz 1.4 µV FM: 28–29.7 MHz 0.5 µV (15 kHz) 50–54 MHz 0.32 µV 144/430 MHz 0.18 µV DV*: 28–29.7 MHz 1.0 µV 50–54 MHz 0.63 µV 144/430 MHz 0.35 µV * With UT-121.
Receiver	Sensitivity for RED <small>(Less than)</small> <small>Preamp ON SSB, AM, FM: at 12 dB SINAD</small>	SSB (2.4 kHz): 1.8–2.999 MHz 10 dBµV emf 3.0–29.999 MHz 0 dBµV emf AM (6 kHz, 60% modulation): 1.8–2.999 MHz 16 dBµV emf 3.0–29.999 MHz 6 dBµV emf	SSB (2.4 kHz): 1.8–2.999 MHz 10 dBµV emf 3.0–29.995 MHz 0 dBµV emf 50/70 MHz band –6 dBµV emf 144/430 MHz band –6 dBµV emf AM (4 kHz, 60% modulation): 1.8–2.999 MHz 16 dBµV emf 3.0–29.995 MHz 6 dBµV emf 50/70 MHz band 0 dBµV emf 144/430 MHz band 0 dBµV emf FM (7 kHz, 60% modulation): 28–29.700 MHz 0 dBµV emf 50/70 MHz band –6 dBµV emf 144/430 MHz band –6 dBµV emf	SSB (2.4 kHz): 1.8–2.999 MHz 10 dBµV emf 3.0–29.999 MHz 0 dBµV emf 50 MHz band –6 dBµV emf 144/430 MHz band –6 dBµV emf* AM (4 kHz, 60% modulation): 1.8–2.999 MHz 16 dBµV emf 3.0–29.999 MHz 6 dBµV emf 50 MHz band 0 dBµV emf 144/430 MHz band 0 dBµV emf* FM (7 kHz, 60% modulation): 28–29.700 MHz 0 dBµV emf 50 MHz band –6 dBµV emf 144/430 MHz band –6 dBµV emf* (*Preamp OFF)
	Selectivity	SSB, CW, RTTY: 2.1 kHz/–6 dB 4.5 kHz/–60 dB AM: 6.0 kHz/–6 dB 20 kHz/–40 dB	SSB: 2.4 kHz/–6 dB (2.4 kHz) 3.4 kHz/–40 dB CW: 500 Hz/–6 dB (500 Hz) 700 Hz/–60 dB RTTY: 500 Hz/–6 dB (500 Hz) 800 Hz/–40 dB AM: 6.0 kHz/–6 dB (6 kHz) 10 kHz/–40 dB FM: 12 kHz/–6 dB (15 kHz) 22 kHz/–40 dB DV (12.5 kHz): –50 dB	SSB: 2.4 kHz/–6 dB (2.4 kHz) 3.4 kHz/–40 dB CW: 500 Hz/–6 dB (500 Hz) 700 Hz/–40 dB RTTY: 500 Hz/–6 dB (500 Hz) 800 Hz/–40 dB AM: 6.0 kHz/–6 dB (6 kHz) 10.0 kHz/–40 dB FM: 12 kHz/–6 dB (15 kHz) 22 kHz/–40 dB DV (With UT-121) : –50 dB (12.5kHz spacing)
	Spurious and image rejection <small>(except IF)</small>	More than 70 dB (1.8–29.999 MHz)	More than 70 dB (HF/50/70 MHz) More than 65 dB (144/430 MHz) <small>(except 1/2 IF through on 50 MHz, IF through on 144 MHz)</small>	HF/50 MHz More than 70 dB 144,430 MHz More than 60 dB
	Audio output power <small>(at 10% distortion with an 8 Ω load)</small>	More than 2.0 W	More than 2.0 W	More than 2.0 W

All stated specifications are subject to change without notice or obligation.

SPECIFICATIONS FOR HANDHELD AND MOBILE TRANSCEIVERS

	ID-51E PLUS2	ID-31E PLUS	IC-V80E
Frequency coverage <small>(Differs according to version)</small>	Europe version: Tx 144–146, 430–440 MHz Rx (A) 144–146, 430–440 MHz (B) 144–146, 430–440 MHz (BC) 0.52–1.71, 76–108 MHz UK version: Tx 144–146, 430–440 MHz Rx (A) 137–174, 380–479 MHz*1 (B) 108–174, 380–479 MHz*1 (BC) 0.52–1.71, 76–108 MHz	Europe version: Tx 430–440 MHz Rx 430–440 MHz UK version: Tx 430–440 MHz Rx 400–479 MHz*3	Tx 144–146 MHz Rx 144–146 MHz
Modes	DV, FM, FM-N, AM (Rx only), WFM (Rx only)	DV, FM, FM-N	FM, FM-N
Max. current drain	2.5 A	2.5 A	1.4 A
Number of Memory channels	554 <small>(500 regular, 50 scan edges and 4 call channels)</small>	552 <small>(500 regular, 50 program scan edges and 2 call channels)</small>	207 <small>(200 regular, 6 scan edges and 1 call channel)</small>
Dimensions <small>(W × H × D; Projections are not included)</small>	58 × 105.4 × 26.4 mm	58 × 95 × 25.4 mm	58 × 112 × 30 mm
Weight <small>(approx.)</small>	255 g with antenna and BP-271	220 g with antenna and BP-271	360 g with antenna and BP-264
Output power <small>(typical values)</small>	High: 5 W Mid: 2.5 W Low2: 1 W Low1: 0.5 W S-Low: 0.1 W <small>(at 7.4 V DC)</small>	High: 5 W Mid: 2.5 W Low2: 1 W Low1: 0.5 W S-Low: 0.1 W <small>(at 7.4 V DC)</small>	High: 5.5 W Mid: 2.5 W Low: 0.5 W <small>(at 7.2 V DC)</small>
Sensitivity <small>(FM: at 12dB SINAD DV: at 1% BER Guaranteed range)</small>	DV Less than 0.28 µV FM/FM-N Less than 0.18 µV <small>(144, 430 MHz bands)</small>	DV Less than 0.28 µV FM/FM-N Less than 0.18 µV	FM/FM-N 0.14 µV typ.
Audio output power <small>(at 10% distortion)</small>	More than 400 mW (Internal SP, 16 Ω load) More than 200 mW (External SP, 8 Ω load)	More than 400 mW (Internal SP, 16 Ω load) More than 200 mW (External SP, 8 Ω load)	750 mW typ. (Internal SP, 16 Ω load) 450 mW typ. (External SP, 8 Ω load)

	ID-5100E	ID-4100E	IC-2730E
Frequency coverage <small>(Differs according to version)</small>	Europe version : Tx 144–146, 430–440 MHz Rx 118–174, 375–550 MHz*1 Italia version : Tx 144–146, 430–434, 435–438 MHz Rx 118–136.991, 144–146, 430–434, 435–438 MHz*2	Europe version : Tx 144–146, 430–440 MHz Rx 118–174, 230–550 MHz*1 Italia version : Tx 144–146, 430–434, 435–438 MHz Rx 118–136.991, 144–146, 430–434, 435–438 MHz*2	Europe version : Tx 144–146, 430–440 MHz Rx 118–174, 375–550 MHz*1 Italia version : Tx 144–146, 430–434, 435–438 MHz Rx 118–136.991, 144–146, 430–434, 435–438 MHz*2
Modes	DV, FM, FM-N, AM (Rx only), AM-N (Rx only)	DV, FM, FM-N, AM (Rx only), AM-N (Rx only)	FM, FM-N, AM (Rx only), AM-N (Rx only)
Max. current drain	13 A	13 A	13 A
Number of Memory channels	1054 <small>(1000 regular, 50 scan edges and 4 call channels)</small>	1054 <small>(1000 regular, 50 scan edges, 4 call channels,)</small>	1052 <small>(1000 regular, 50 scan edges and 2 call channels)</small>
Dimensions <small>(W × H × D; Projections are not included)</small>	Main unit: 150 × 40 × 172.6 mm Controller: 182.2 × 81.5 × 24.7 mm	Main unit + Controller: 150 × 40 × 171.9 mm Controller: 122 × 40 × 29.7 mm	Main unit: 150 × 40 × 151 mm Controller: 150 × 50 × 27.2 mm
Weight <small>(approx.)</small>	Main unit: 1.3 kg Controller: 260 g	Main unit: 1.1 kg Controller: 100 g	Main unit: 1.2 kg Controller: 140 g
Output power <small>(typical values)</small>	High: 50 W Mid: 15 W Low: 5 W <small>(at 13.8 V DC)</small>	High: 50 W Mid: 15 W Low: 5 W <small>(at 13.8 V DC)</small>	Main unit: 1.2 kg Controller: 140 g
Sensitivity <small>(FM: at 12dB SINAD DV: at 1% BER Guaranteed range)</small>	DV Less than 0.28 µV FM/FM-N Less than 0.18 µV <small>(144, 430 MHz bands)</small>	DV Less than 0.22 µV FM/FM-N Less than 0.18 µV <small>(144, 430 MHz bands)</small>	FM/FM-N Less than 0.18 µV <small>(144, 430 MHz bands)</small>
Audio output power <small>(at 10% distortion)</small>	More than 2.0 W (8 Ω load)	More than 2.0 W (8 Ω load)	More than 2.0 W (8 Ω load)

*1 Guaranteed range 144–146 and 430–440 MHz. *2 Guaranteed range 144–146, 430–434 and 435–438 MHz. *3 Guaranteed range 430–440 MHz.

(A) means VFO A receiver, (B) means VFO B receiver, (BC) means broadcast radio.

All stated specifications are subject to change without notice or obligation.



Applicable U.S. Military Specifications

Icom makes rugged products that have been tested to and passed the MIL-STD requirements and strict environmental standards for shock and vibration.

SPECIFICATIONS FOR RECEIVERS

	IC-R8600	IC-R30	IC-R6
Frequency coverage <small>(Differs according to version)</small>	0.01–3000 MHz*1	A band: 0.1 – 3304.999 MHz B band: 108 – 520 MHz	0.1–1309.995 MHz
Mode	USB, LSB, CW, FSK, AM, FM, WFM, D-STAR (DV), P25, NXDN, dPMR, DCR, S-AM	A band: (≤1300 MHz) FM, FM-N, WFM, AM, AM-N, SSB, CW, D-STAR (DV), P25, dPMR, NXDN, DCR (>1300 MHz) FM, FM-N, WFM, AM, AM-N B band: FM, AM, D-STAR (DV), P25, dPMR, NXDN, DCR	FM, WFM, AM
Frequency stability	Less than ±0.5 ppm (at 25°C after warm up)	Less than ±2.5 ppm (–20°C to 60°C)	±1.0 ppm (at 25°C)
Maximum current drain	2.0 A	330 mA typical (at 3.6 V DC)*2	130 mA typical (at 3.0 V DC)*3
Antenna connector	ANT1: Type-N (50 Ω), ANT2: SO-239 (50 Ω), ANT3: RCA (500 Ω)	SMA (50 Ω)	SMA (50 Ω)
Dimensions <small>(Projections are not included)</small>	220 (W) × 90 (H) × 230 (D) mm	58 (W) × 143 (H) × 30.5 (D) mm	58 (W) × 86 (H) × 29.8 (D) mm
Weight <small>(approx.)</small>	4.3 kg	310 g with antenna and BP-287 battery pack	200 g with antenna and battery cells
Sensitivity <small>SSB, CW, RTTY, AM, FSK: at 10 dB S/N FM, WFM: at 12 dB SINAD D-STAR, NXDN, dPMR, DCR: at 1% BER P25: at 5% BER</small>	SSB/CW/FSK (Preamp ON, BW: SSB/FSK=2.4 kHz, CW=0.5 kHz): 0.1–1.799 MHz 0.5 μV 1.8–29.999 MHz 0.2 μV 30–1999.999 MHz 0.32 μV 2000–3000 MHz 0.4 μV AM (Preamp ON, BW=6 kHz): 0.1–1.799 MHz 6.3 μV 1.8–29.999 MHz 2.5 μV 30–3000 MHz 5.6 μV FM (Preamp ON, BW=15 kHz): 28–1999.999 MHz 0.5 μV 2000–3000 MHz 0.63 μV WFM (Preamp ON, BW=180 kHz): 30–1999.999 MHz 1.4 μV 2000–3000 MHz 1.8 μV D-STAR (DV)/NXDN/dPMR/DCR (Preamp ON): 28–1999.999 MHz 0.79 μV 2000–3000 MHz 1 μV P-25 (Preamp ON): 28–1999.999 MHz 0.56 μV 2000–3000 MHz 0.71 μV	SSB/CW: 0.495–1.899 MHz Less than 0.4 μV 1.9–29.999 MHz Less than 0.25 μV 50–53.999 MHz Less than 0.25 μV 144–147.999 MHz Less than 0.25 μV 430–449.999 MHz Less than 0.32 μV AM: 0.495–1.899 MHz Less than 2.2 μV 1.9–29.999 MHz Less than 1.4 μV 118–136.999 MHz Less than 1.4 μV FM: 28–221.999 MHz Less than 0.4 μV 222–1299.999 MHz Less than 0.56 μV 1300–1999.999 MHz Less than 1.8 μV 2000–2699.999 MHz Less than 1.8 μV 2700–3304.999 MHz Less than 18 μV WFM: 76–107.999 MHz Less than 1.8 μV D-STAR (DV): 28–29.999 MHz Less than 0.71 μV 50–53.999 MHz Less than 0.71 μV 144–147.999 MHz Less than 0.71 μV 430–449.999 MHz Less than 1 μV 1260–1299.999 MHz Less than 1 μV NXDN/dPMR/DCR: 136–173.999 MHz Less than 0.71 μV 350–511.999 MHz Less than 1 μV P25: 136–173.999 MHz Less than 0.4 μV 400–469.999 MHz Less than 0.56 μV 763–869.999 MHz Less than 0.71 μV	FM (typical): 1.625–4.995 MHz 0.32 μV 5–29.995 MHz 0.25 μV 30–469.995 MHz 0.18 μV 470–832.995 MHz 0.32 μV 833–1029.995 MHz 0.28 μV 1030–1309.995 MHz 0.35 μV WFM (typical): 76–108 MHz 1.1 μV 175–221.995 MHz 1.1 μV 470–770 MHz 1.8 μV AM (typical): 0.495–4.995 MHz 1.3 μV 5–29.995 MHz 0.89 μV 118–136 MHz 0.63 μV 222–246.995 MHz 0.63 μV 247–329.995 MHz 0.79 μV
Sensitivity for RED <small>Preamp ON SSB, AM, FM: at 12 dB SINAD (Only for amateur band. With CCITT filter ON)</small>	SSB, FSK (Less than, BW=2.4 kHz) 0.1–2.999 MHz 10 dBuV emf 3–29.999 MHz 0 dBuV emf 30–3000 MHz –6 dBuV emf AM (Less than, BW=4 kHz) 0.1–2.999 MHz 16 dBuV emf 3–29.999 MHz 6 dBuV emf 30–3000 MHz 0 dBuV emf FM (Less than, BW=7 kHz) 3–29.999 MHz 0 dBuV emf 30–3000 MHz –6 dBuV emf	–	–
Selectivity	SSB/FSK (BW=2.4 kHz): More than 2.4 kHz/–3 dB Less than 3.6 kHz/–60 dB CW (BW=500 Hz): More than 500 Hz/–3 dB Less than 700 Hz/–60 dB AM (BW=6 kHz): More than 6.0 kHz/–3 dB Less than 15.0 kHz/–60 dB FM (BW=15 kHz): More than 12.0 kHz/–6 dB Less than 25.0 kHz/–60 dB WFM: More than 180 kHz/–6 dB	SSB/CW: More than 1.8 kHz/–6 dB AM/FM: More than 12 kHz/–6 dB, Less than 30 kHz/–60 dB (below 1305 MHz), Less than 30 kHz/–40 dB (above 1305 MHz) WFM: More than 150 kHz/–6 dB	AM, FM: More than 12 kHz/–9 dB Less than 30 kHz/–60 dB WFM: More than 150 kHz/–6 dB
Audio output power <small>(at 10% distortion)</small>	More than 2.0 W (8 Ω load)	More than 400 mW (Internal SP, 16 Ω load) More than 200 mW (External SP, 8 Ω load)	150 mW (Internal SP, 16 Ω load) 80 mW typical (External SP, 8 Ω load)

*1 Working range. *2 FM mode single receive, voice recording OFF, GPS OFF, back light OFF. *3 External SP, backlight OFF.

All stated specifications are subject to change without notice or obligation.

Icom, Icom Inc. and the Icom logo are registered trademarks of Icom Incorporated (Japan) in Japan, the United States, the United Kingdom, Germany, France, Spain, Russia, Australia, New Zealand and/or other countries. Android and Google Play are registered trademarks or trademarks of Google Inc. The Bluetooth® word mark and logos are registered trademarks owned by Bluetooth SIG, Inc. and any use of such marks by Icom Inc. is under license. IOS is a trademark or registered trademark of Cisco in the U.S. and other countries and is used under license. App Store is a service mark of Apple Inc. Windows is either a registered trademark or a trademark of Microsoft Corporation in the United States and/or other countries. dPMR is a trademark of the dPMR MoU Association. NXDN is a trademark of Icom Incorporated and JVC KENWOOD Corporation. All other trademarks are the properties of their respective holders.

Icom Inc. 1-1-32, Kamiminami, Hirano-Ku, Osaka 547-0003, Japan Phone: +81 (06) 6793 5302 Fax: +81 (06) 6793 0013

www.icom.co.jp/world

Count on us!

Icom America Inc.
www.icomamerica.com

Icom (Europe) GmbH
www.icomeurope.com

Icom (Australia) Pty. Ltd.
www.icom.net.au

Your local distributor/dealer:

Icom Canada
www.icomcanada.com

Icom Spain S.L.
www.icomspain.com

Shanghai Icom Ltd.
www.bjicom.com

Icom Brazil
E-mail: sales@icombrasil.com

Icom (UK) Ltd.
www.icomuk.co.uk

Icom France s.a.s.
www.icom-france.com