



Mobile
Transceivers



Multi-Band
Transceivers



Handheld
Transceivers



Base Station
Transceivers

RMDR (Reciprocal Mixing Dynamic Range) of 110 dB* (at 1 kHz)

Completely Independent Dual Receiver Receives Two Bands Simultaneously

High-Speed, High-Resolution Spectrum Waterfall Scope

Crystal Clear, High-purity Local Oscillator

Full Duty 200 W Output Power

1.2 kHz Optimum Roofing Filter Greatly Improves In-band Adjacent Signal Performance

Audio Scope and Oscilloscope for Watching Receive and Transmit Audio

* At a 1kHz offset frequency. Receiving frequency: 14.2 MHz. Mode: CW, IF BW: 500 Hz, Roofing Filter: 1.2 kHz

Experience in video

http://www.icom.co.jp/r/ic-7851_me/



HF/50MHz TRANSCEIVER IC-7851

RMDR: 110 dB, Raising the Bar Again

Design advances developed by the Icom HF engineers for the Local Oscillator (LO) enable the IC-7851 to set a new benchmark for amateur radio receivers. The goal was to dramatically reduce the phase noise that degrades the target signal due to the sum of the entire signal present. The result was a RMDR of 110 dB*. Below is a comparison of the improvement over the IC-7800.

* At a 1 kHz offset frequency

Receiving frequency: 14.2 MHz Mode: CW, IF BW: 500 Hz
Roofing Filter IC-7800 = 3 kHz, IC-7851 = 1.2 kHz

■ RMDR Comparison

	RMDR(dB)			
	1kHz	2kHz	10kHz	20kHz
IC-7851	110	116	121	124
IC-7800	78	87	106	112

RMDR

RMDR (Reciprocal Mixing Dynamic Range) is the relative level of an undesired signal, offset "n" kHz from the RX passband, which will raise noise floor by 3 dB. The local oscillator phase noise will mix with strong unwanted signals and unavoidably generate noise which masks a wanted signal.

1.2 kHz Optimum Roofing Filter

Despite the trend to switch to a down conversion or a hybrid conversion receive design, Icom believes in the solid performance of the up-conversion design. The IC-7851 introduces a new 1.2 kHz Optimum Roofing Filter, greatly improving the in-band adjacent signal performance. This newly developed filter overcomes the gap of a narrower roofing filter in an up-conversion receiver.



Optimum Roofing Filter

Crystal Clear LO Design

Breaking the boundaries of traditional designs, the IC-7851 employs a Direct Digital Synthesizer (DDS) along with a Phase Locked Oscillator for the LO (Local Oscillator). The C/N ratio excels beyond the IC-7800 and other similar class HF transceivers. This design significantly reduces noise components in both receive and transmit signals.

■ LO C/N Characteristics Comparisons

Receiving Frequency: 14.2 MHz Mode: CW 1st LO frequency: 78.655 MHz
SPAN = 20 kHz, RBW = 30 Hz, VBW = 10 Hz

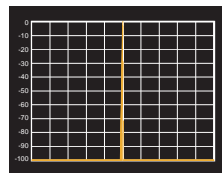

IC-7851

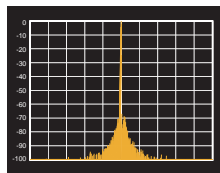

IC-7800

Improved Phase Noise Characteristics

Phase noise is coherent in radio circuit design and the new LO design introduced in the IC-7851 makes some major breakthroughs while utilizing the 64 MHz, up-conversion receiver design introduced in the IC-7800. An impressive 20 dB improvement is seen with the IC-7851's 10 kHz measurement and more than 30 dB improvement at a 1 kHz measurement in comparison to the IC-7800.

■ Phase Noise Characteristics Comparisons

Receiving Frequency: 14.2 MHz Mode: CW 1st LO frequency: 78.655 MHz

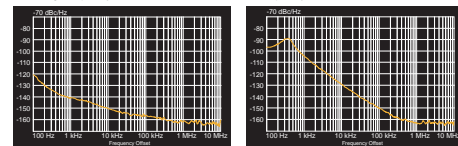

IC-7851

IC-7800

Improved Spectrum Scope

Following the design lineage of the IC-7800, the IC-7851 uses a dedicated DSP unit for the Fast Fourier Transform (FFT) spectrum. The 2250 MFLOPS DSP processor enables a new dual scope function and significantly faster sweep speeds and better accuracy than in the IC-7800.

■ Scope Comparison

	IC-7851	IC-7800
Span Width	5 kHz-1000 kHz	5 kHz-500 kHz
Resolution **	1 pixel minimum **	20 pixels minimum **
Sweep Speed	29.3 frames/Sec **	4 frames/Sec **
Display Dynamic Range	100 dB	80 dB
Noise Floor Level	-30 dBμ	-19 dBμ

** Number of dots shown at the 60 dB level, when receiving a signal.

** SPAN = More than 20 kHz, SPEED = Slow

** SPAN = Less than 20 kHz, SPEED = Fast

** SPAN = 500 kHz, SPEED = Slow

Base Station Transceivers



+40 dBm IP3 (3rd Order Intercept Point)

The IC-7851 continues the +40 dBm, 3rd order intercept point and 110 dB receiver dynamic range benchmark set by the IC-7800. To achieve this superb receiver performance, the entire analog circuitry and components have been re-engineered to match the DSP units. A newly designed LO amplifier generates high output while keeping flat frequency characteristics over a 60 MHz wide range.

Dual Spectrum Scope with Waterfall Function

The IC-7851 introduces the new dual scope – the ability of watching both receivers in separate spectrum scopes. The dual scope function is vital for watching for multipliers or band openings in contests, or working all bands/modes on a DXpedition. The waterfall display captures signal strengths over time. This allows you to see signals that may not be apparent on a normal scope.



Dual scope example (Horizontally aligned)

Full Duty 200 W Output Power

The push-pull power amplifiers using power MOS-FETs work on 48 V DC. They provide a powerful 200 W output power at full duty cycle. An effective cooling system maintains internal temperatures within a safe range and prevents thermal runaway.

Digital IF Filter

Icom's digital IF filters give you performance that is not possible with crystal or mechanical filters. They allow the operator to adjust filter shape (sharp or soft), filter bandwidth, and center frequency characteristics, without missing the action.

Other Outstanding Features

[Antenna and receiver] • Two completely independent receivers • 15 kHz, 6 kHz, 3 kHz and 1.2 kHz four 1st IF Roofing filters • Four antenna connectors with automatic antenna

selector • Automatic antenna tuner • 50 MHz special preamp and mixer circuit • Digital manual notch • Digital twin PBT eliminates interference from adjacent signals • New auto digital noise blanker • ± 0.05 ppm High Stability OCO Unit

[CW mode] • DSP-controlled CW keying waveform shaping • Multi-function electronic keyer with adjustable keying speed, dot-dash ratio and paddle polarity • Audio Peak Filter selection (soft/sharp)

[Operation] • High-quality digital voice recorder memory • Built-in RTTY, PSK31 and PSK63 without the use of a computer • Message memory for CW, RTTY and PSK31/63 • Digital video interface (DVI-I) • SD memory card slot • Audio scope function • Click control spectrum scope • AGC control • Microphone equalizer and adjustable transmit bandwidth • FFT scope averaging function for PSK and RTTY decode • Screen saver function



- RMDR (Reciprocal Mixing Dynamic Range) of 110 dB* (at 2kHz)**
- Independent Dual Receiver Receives Two Bands Simultaneously**
- Superior Transmit Phase Noise Characteristics**
- DIGI-SEL Preselector for Main and Sub Bands**
- High-Speed, High-Resolution Real-time Spectrum Scope**
- Touch Screen and Multi-Dial Knob for Smooth Operation**
- DVI-D Digital Connector for External Display Connection**



* At a 2 kHz offset frequency. Receiving frequency: 14.2 MHz Mode: CW, IF BW: 500 Hz

HF/50MHz TRANSCEIVER IC-7610

Innovative RF Direct Sampling System Achieves 110 dB* (typ) RMDR

The RF direct sampling system directly converts the analog signals to digital signals, and collectively puts the data through FPGA (Field-Programmable Gate Array) processing. The master clock uses a high precision VCXO (Voltage Controlled Crystal Oscillator) which excels in low-noise characteristics. This makes it possible to provide superior receive and transmit performance, extremely low phase noise as well as high RMDR (Reciprocal Mixing Dynamic Range).

* At 2 kHz frequency separation.

■ RMDR Characteristics

* Received frequency: 14.2 MHz, MODE: CW, IF BW: 500 Hz

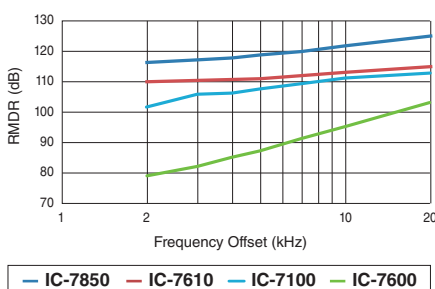

Independent Dual Receiver Receives Two Bands Simultaneously

The dual receiver is ideal for simultaneous monitoring of two bands and two modes. The sub receiver works independently of the main receiver. The optional RC-28 can be used as the main dial for the sub band.

Superior Transmit Phase Noise Characteristics

Breaking with tradition of mixing a carrier signal with a local oscillator, a Digital-Up-Conversion (DUC) is used for generating required frequencies by sampling the Digital to Analog Converter (DAC). The superior Phase Noise characteristics provide high purity transmit signals.

DIGI-SEL Firmly Shuts Out Interference Signals

Both main and sub receivers are equipped with DIGI-SEL (digital preselector) units. The DIGI-SEL has steeper skirt characteristics than normal band-pass filters, so it rejects out of band strong interference such as broadcast stations, and prevents cross modulation.



High-Speed, High-Resolution Real-time Spectrum Scope

The real-time spectrum scope of the IC-7610 shows main and sub band conditions. It provides class-leading performance in resolution, sweep speed and a 100 dB of dynamic range. The waterfall screen allows you to find weak signals by showing the spectrum change over time. Connecting a PC mouse to the USB port aids in flexible use of the spectrum scope.

FFT Scope and Oscilloscope for Audio Observation

The audio scope function shows the FFT scope with waterfall and the oscilloscope of either transmitting or receiving audio. This function can be used for observing various AF characteristics such as microphone compressor level, filter width, notch filter and receive keying waveform in CW mode.

Touch Screen and Multi-Dial Knob for Smooth Operation

The combination of the touch screen and the multi-dial knob offers quick and smooth operation. When you push the multi-dial knob, menu items are shown on the right side of the display. You can select an item with a touch of the screen and adjust levels by turning the multi-dial knob.

Base Station Transceivers



DVI-D Connector for External Display Connection

The IC-7610 has a DVI-D digital connector for an external display. Operating frequency, setting information and spectrum scope can be observed on a large external display.

High Sound Quality Speaker

The IC-7610's speaker offers comfortable sound quality with flat overall frequency response and loud and intelligible audio for making use of the high-purity received signal. Insulators are placed between the speaker and chassis for preventing vibration noise.

SD Card Slot and USB ports for Saving Data

For multi-operators using one rig, personal settings such as filter settings, memory channels, and antenna settings, can be loaded using the SD card/USB memory stick. TX Voice memories and RTTY/CW memories on the SD card/USB memory stick can be sent with a touch of button.

I/Q Signal Output

The I/Q signal output function* allows you to derive digital IF signals from the I/Q output jack. It can be used for analysing spectrum or decoding signals.

* This function will be provided with a future firmware update. A third-party software may be required separately.

Other Outstanding Features

[Antenna and receiver] • BNC type RX IN/OUT connectors • Built-in automatic antenna tuner • Two types of preamplifiers • 3 dB – 45 dB attenuator • IP+ function improves third order intercept point performance • RTTY demodulator and decoder • Digital twin PBT eliminates interference from adjacent signals

[Transmitter] • TX monitor function • All mode power control • VOX (voice operated transmission) capability • Microphone equalizer and adjustable transmit bandwidth • 50 CTCSS tones

[CW mode] • FPGA-controlled CW keying waveform shaping • Multi-function electronic keyer • CW pitch control from 300 Hz to 900 Hz • Auto repeat function • Contest serial number counter • Normal or short morse

number style • Double key jack system • Full break-in and semi break-in • CW auto tuning • APF (Audio Peak Filter) function adjustable filter shape, width and AF level

[Operation] • 7-inch wide colour TFT LCD • Simplified IP remote control capability with the optional RS-BA1 • Memo pad stores up to 10 operating frequencies and modes • Quick split function • Quick dualwatch function • RF gain and squelch control with a knob • RIT and Δ TX variable up to 9.999 kHz • UTC/local clock and timer function • 1 Hz pitch tuning and display • 101 memory channels • Dial lock function • Adjustable main dial tension • External speaker jacks for main and sub receivers • Multi-function meter • Auto tuning step function • AGC control for fine tuning of the AGC time constant • Screen saver function





HF/50MHz TRANSCEIVER

IC-7700

+40 dBm Third-Order Intercept Point (in the HF Bands)

Spectrum Scope with Waterfall Function

200 W Output Power and High-stability Transmitter

+40 dBm IP3 (3rd order Intercept Point) and 110 dB Dynamic Range

The IC-7700 employs mechanical relay BPF switching, a digitally tuned pre-selector, and three hi-spec 1st IF filters (roofing filters) in a clean and simple double conversion superheterodyne design. By balancing the analog and DSP functions, the IC-7700 provides superior sensitivity simultaneously with a superb dynamic range of 110 dB, and +40 dBm IP3 (even in USB mode with 2.4 kHz filter bandwidth).

More than +110 dBm IP2 (2nd order Intercept Point)

An IP2 point of more than +110 dBm* means 2nd order distortion from strong broadcast stations will be completely eliminated.

* The IP2 figure is a typical value.

** Measurements were made using custom equipment, due to the limits of normal signal generators (SG) and duplexers to +85 dBm.

High Specification Inband IMD

All (2nd, 3rd or even higher) orders of IMD performance are superior in the IC-7700. You'll notice the difference as you copy weak signals without internal distortion or noise, especially evident in CW mode.

Spectrum Waterfall Display

The spectrum waterfall function can show the changing amplitude of frequency spectrum over time. A weak signal which cannot be recognized with the spectrum scope may be found in the waterfall screen. With the high performance receiver, the IC-7700 increases your chances of making QSOs.



Spectrum scope with waterfall (wide screen setting)

Mouse Operation for Spectrum Scope

By connecting a PC mouse to the USB port, the spectrum scope operation is possible with a mouse.

Audio Scope Function for AF Observation

The audio scope function can be used for observing various AF characteristics such as microphone compressor level, filter width, notch filter and CW keying waveform.

200 W Full Duty Operation

The IC-7700 uses a STAC2942 power amplifier in push-pull configuration. The digital PSN modulator consistently reproduces an outstanding signal-to-noise ratio, providing clean and low IMD transmission on all bands.

Other Outstanding Features

- Simplified remote control operation with optional RS-BA1
- QSO recording function into USB flash drive
- 15 kHz, 6 kHz, and 3 kHz Hi-spec 1st IF filters (roofing filter)
- Image rejection mixer is used for the 2nd mixer
- Low distortion bandpass filter and mechanical relays
- DIGI-SEL automatic preselector rejects out of band strong interference
- High Intercept point and low noise preamplifier
- Two AGC loop lines improve dynamic range and blocking from strong interference
- ±0.05 ppm high stability OXCO unit
- RTTY and PSK 31 operation without PC connection
- USB connectors on the front panel
- 4 antenna connectors with automatic antenna selector
- Digital twin PBT eliminates interference from adjacent signals
- Flexible digital IF filter setting
- Manual and auto notch filter
- Microphone equalizer and adjustable transmit bandwidth
- VGA connector for an external display connection

Firmware Update Available (Free Download)
<http://www.icom.co.jp/world/support/index.html>

Dynamic range characteristics (in 14MHz band)

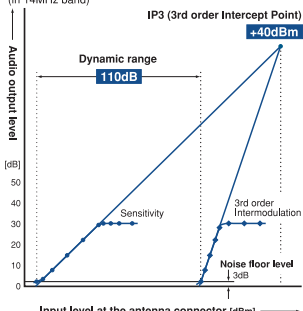

DIGI-SEL unit



BPF unit

Base Station Transceivers

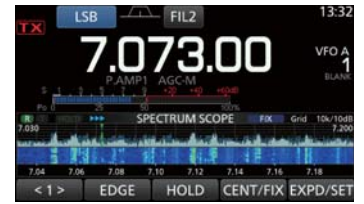

Spectrum scope + Waterfall



FFT scope/Oscilloscope



Touch screen interface

HF/50/70MHz TRANSCEIVER IC-7300

Class Leading Real-time Spectrum Scope with Waterfall Function

RF Direct Sampling System

New "IP+" Function

Class Leading Real-time Spectrum Scope with Waterfall Function

The IC-7300's real-time spectrum scope is class-leading in resolution, sweep speed and dynamic range. While listening to received audio, you can check the real-time spectrum scope and quickly move to an intended signal.

Real-time Spectrum Scope Specifications

	IC-7300
Scope system	FFT (Fast Fourier Transform)
Span width	5 kHz-1000 kHz
Resolution *	1 pixel minimum (approximately)
Sweep speed	Max. 30 frames/second (approximately)
Waveform display area (vertical axis)	80 dB
Other functions	Waterfall function, Audio scope function

* Number of pixels shown at the 60 dB level, when receiving a signal.

RF Direct Sampling System

The IC-7300 employs an RF direct sampling system. RF signals are directly converted to digital data and processed in the FPGA (Field-Programmable Gate Array), making it possible to simplify the circuit construction. This system is the new benchmark technology making an epoch in amateur radio.

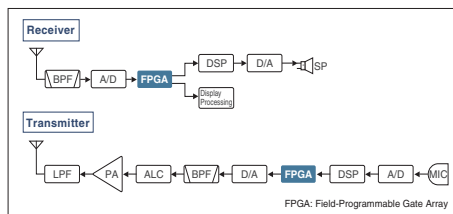

Class Leading RMDR and Phase Noise Characteristics

The IC-7300's RMDR is improved to about 100 dB* (typical value) and Phase Noise characteristics are improved about 15 dB (at 1 kHz frequency separation) compared to the IC-7200. The superior Phase Noise characteristics reduce noise components in both receive and transmit signals.

* At 2 kHz frequency separation (received frequency: 14.2 MHz, MODE: CW, IF BW: 500 Hz)

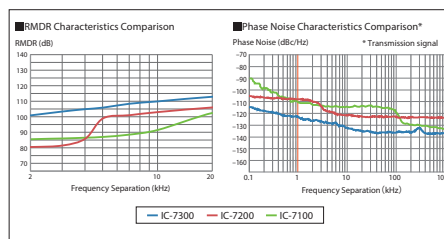

New "IP+" Function

The new "IP+" function improves the third order intercept point (IP3) performance. When a weak signal is received adjacent to strong interference, the AD converter is optimised against signal distortion.

15 Discrete Band-pass Filters

The IC-7300 has 15 discrete RF bandpass filters. The RF signal is only passed through one of the bandpass filters, while any out of range signals are rejected. High Q factor coils are used to minimize the loss in the RF band-pass filters.

Superior Signal Quality

The RF direct sampling system is naturally superior at signal linearity and noise immunity by digitally processing the signal from RF to AF. Mathematical frequency conversions within the FPGA drastically improve the signal purity. Thanks to these features, though it is a compact radio, the IC-7300 enjoys exceptionally clear and rich sound which normally can only be expected for a higher class radio.

Large Touch Screen Colour TFT LCD

The large 4.3 inch colour TFT touch LCD offers intuitive operation. Using the software keypad, you can easily set various functions and edit memory contents.

Other Features

- Audio scope function
- Built-in automatic antenna tuner
- Multi-dial knob for smooth operation
- SD card slot for saving data
- New speaker unit design
- HM-219 hand microphone supplied
- A large and effective cooling fan system
- Multi-function meter
- 101 memory channels (99 regular, 2 scan edges)
- Optional RS-BA1 IP remote control software (the spectrum scope with the waterfall can be observed)
- CW functions: Full break-in, CW reverse, CW auto tuning
- 70 MHz band is available for EUR version

Base Station Transceivers



design with an image rejection mixer for the 2nd mixer stage is employed in the IC-7410. This receiver design not only reduces the electronic complexity, it greatly reduces the number of internal distortion points from older triple and quadruple conversion receivers.

+30 dBm Class Third-order Intercept Point (IP3)

In Icom's continuing efforts to create the best receiver, the design of the IC-7410 incorporates the latest in DSP software technology and Icom's analog RF circuit experience for a +30 dBm* (typ.) IP3. The end result, clear reception of weak signals surrounded by QRM from broadcast and neighboring ham stations.

* Typical in 14 MHz band. Spacing=100 kHz

Other Features

- Three first IF filters (3/6/15 kHz)
- Digital twin PBT
- AGC loop management with programmable AGC time constant
- Auto/manual notch filter provide more than 70 dB attenuation
- Noise reduction
- RF speech compressor
- User programmable tone control
- Built-in voice synthesizer
- User programmable band edge beep
- VSC (Voice Squelch Control) function
- Two preamplifier types: Preamp 1: Improving IMD characteristics, Preamp 2: High gain preamplifier
- 20 dB built-in attenuator
- Built-in automatic antenna tuner
- CTCSS tone encoder and decoder

HF/50MHz TRANSCEIVER IC-7410

Faster DSP Unit and
In-house DSP Expertise

Dual-conversion Superheterodyne

+30 dBm Class Third-order
Intercept Point (IP3)

Faster DSP Unit and In-house DSP Expertise

Icom brings out the best DSP performance, combining more than ten years of DSP technical know-how and much faster DSP pro-

cessors. Icom's in-house DSP experts have developed a IC-746PRO series replacement that every operator will be proud to own. In addition to the higher speed DSP, the AD/DA converter, AK4620, provides a higher dynamic range and superior S/N ratio.



<DSP unit> ADSP-21369
Internal clock speed: 333 MHz
32-bit floating point DSP
Max. performance: 2000MFLOPS

AD/AD converter
ADC Signal/(Noise+Distortion): 10 dB
DAC Dynamic range, S/N: 133 dB
DAC Signal/(Noise+Distortion): 97 dB
DAC Dynamic range, S/N: 115 dB

Double-conversion Superheterodyne

Introduced with our top-of-the-line transceiver, a double-conversion superheterodyne



Optional DSP Capability, UT-106

The optional DSP unit gives you noise reduction and auto notch filter functions for extra receiver performance.



Optional UT-106

General Coverage Receiver

The IC-718 has 0.03-29.999999 MHz* general coverage receive capability.

* Guaranteed range: 0.5-29.999999 MHz

Interference rejection – IF shift

To reject interference, the IC-718 has an IF shift function which shifts the center frequency of the IF passband electronically to reduce adjacent interference.

Other Features

- Front mounted loud speaker
- General coverage receiver
- Built-in electronic keyer
- Built-in microphone compressor
- Combined squelch and RF gain control
- Preamplifier and attenuator
- 101 memory channels
- CW full break-in
- IF shift interference rejection
- 1 Hz tuning
- VOX function for hands-free operation
- Optional automatic antenna tuner
- Digital S/Rf meter

HF TRANSCEIVER IC-718



Simple, Straightforward Operation with Keypad

The IC-718 is equipped with a minimum number of buttons and controls for simple feature selection. The 10-key pad on the front panel allows direct entry of an operating frequency or a memory channel number. The auto tuning step function is activated when turning the dial quickly and helps speed up tuning. The band stacking register is convenient when changing operating bands.

Front Mount Loud Speaker

The IC-718 has the speaker mounted on the front panel. With the speaker facing the operator, audio will be heard clearly and directly while operating.

Simple, Straightforward Operation
with Keypad

Front Mount Loud Speaker

Optional DSP Capability, UT-106

Multi-Band Transceivers

DIGITAL



DR (D-STAR Repeater) mode operation



Near repeater function



SD card slot for saving data

HF/VHF/UHF TRANSCEIVER IC-7100

Intuitive Touch Screen Interface

Controls at Your Fingertips
with an Angled Display

HF, 50/70/144/430 MHz Multi-band

Intuitive Touch Screen Interface

The innovative touch screen interface provides quick and smooth operation for setting and editing various functions and memories.

One Touch Selection

For example, if you want to change the operating band, tap the frequency on the display. The band keys will be shown to select the operating band. Touching the multi-function meter indicator for 1 second will quickly change the transmit meter functions.



Straightforward Operation

Just tap the mode, filter, function etc., you need to change. The touch screen responds naturally changing your settings.



HF, 50/70/144/430 MHz Multi-band

The IC-7100 fully covers the HF, 50, 70, 144, 430 MHz amateur bands in multiple modes, providing 100 W on HF/50 MHz bands, 50 W on 70/144 MHz band and 35 W on 430 MHz band.

Digital Features Controlled by the IF DSP

A high-performance 32-bit floating point IF DSP delivers rich digital signal processing features, including digital IF filter, digital twin PBT, noise reduction, CW auto tune, etc. Those digital features work on all bands from HF to V/UHF bands.

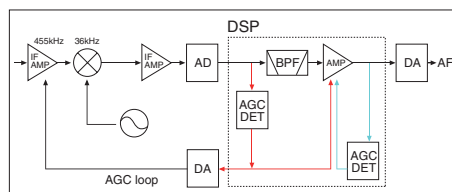

AGC function loop

Built-in RTTY Functions

The built-in RTTY decoder allows you to instantly read an RTTY message on the display. Your RTTY operating log, both TX and RX, is recorded on an SD card. The eight RTTY memories can memorize and transmit often used RTTY sentences.

D-STAR DV Mode (Digital Voice + Data)

The IC-7100 provides D-STAR DV mode digital voice and low-speed data communication.

DR (D-STAR Repeater) Function Operation

The DR function operation makes the D-STAR operation simple and straightforward, even if you are new to D-STAR operation.

Repeater Search Function

With an external GPS receiver*, this function searches the nearby D-STAR repeaters from the internal database based on your location.

* External GPS receiver or manual position data input required.

Controller Mounted Speaker and Jacks

The unique remote head design is perfect for providing loud, clear audio as well as jacks for an external speaker/headphones, key and microphone.

Controller Rear Panel View



SD Card Slot for Saving Data

When used with an SD card, the SD card can store various contents including voice memory, memory channels, D-STAR repeater memories and other personal settings can be saved to the SD card and can be loaded to the transceiver.

Other Features

- DSP controlled AGC function loop
- Easy vehicle mounting with optional MBF-1
- RS-MS1A remote control software for an Android™ device (Send and receive pictures)
- Optional RS-BA1 IP remote control software
- CW full break-in, CW receive reverse, CW auto tuning
- Optional multi-function microphone, HM-151
- Band scope and SWR graphic display
- RF speech compressor controlled by the DSP
- Voice memory function
- Multi-function meter
- 495 regular, 4 call, 6 scan edge and 900 DR mode repeater channels
- 4 channels TX voice memories
- ±0.5 ppm frequency stability
- Auto reply function*
- Digital callsign squelch (DSQL) and digital code squelch (CSQL)*
- 12.5 kHz IF output for DRM (Digital Radio Mondiale) receive

* D-STAR DV mode only

Firmware Update Available (Free Download)
<http://www.icom.co.jp/world/support/index.html>

Multi-Band Transceivers

DIGITAL (With optional UT-121)



HF/VHF/UHF TRANSCEIVER

IC-9100

**Multi-band,
Dual Independent Receiver**

**+30 dBm Class Third-order
Intercept Point (IP3)**

Satellite Mode Operation

Multi-band, Dual Independent Receiver

The IC-9100 covers 100W on HF, 50 MHz and 144 MHz, 75 W on 430 MHz bands. The radio has 3 independent receiver circuits from the antenna connector to the second IF mixer (image rejection mixer) and simultaneously receives two different bands (1. HF/50 MHz + 144/430 MHz, 2. 144 MHz + 430 MHz) at a time.

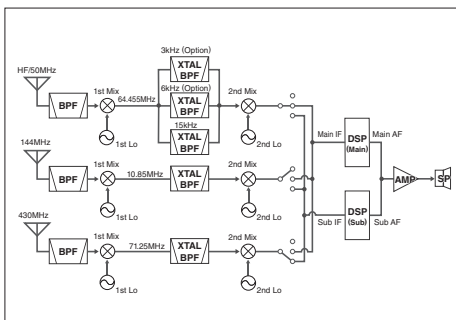

+30 dBm Class IP3

Using receiver design techniques introduced in Icom's highest grade HF transceivers, the IC-9100 has an IP3 of +30 dBm* in the HF band. Even a weak signal adjacent to strong signals is clearly received by the IC-9100.

* Typical in 14 MHz band. Spacing=100 kHz

Satellite Mode Operation

The satellite mode synchronizes the uplink (transmitting) and downlink (receiving) frequencies, and tracks the frequencies in the same tuning step. This function matches both normal and reverse mode satellites. Compensation of the Doppler effect can be performed easily. 20 satellite memory channels store frequencies, mode and tone settings for quick setup.

Superb readability in the VHF/UHF band

The IC-9100 has a top class receiver performance in the VHF/UHF bands, indispensable for obtaining weak signals in the satellite communication. The IF DSP greatly improves intermodulation and noise elimination and offers good readability.

Optional D-STAR DV Mode

The optional UT-121 provides D-STAR DV mode digital voice and low speed data communication. Linking of D-STAR repeaters over the Internet allows you to communicate vir-



▲Optional UT-121

tually anywhere. The D-STAR repeater (DR) function makes it easy to access D-STAR repeaters.

Three First IF Filters (3/6/15 kHz) for HF/50 MHz Band

The IC-9100 comes with a built-in 15 kHz 1st IF filter and can accept up to two optional filters (3 kHz FL-431 and 6 kHz FL-430). By changing the first IF filter width according to the operating mode, the desired is protected from adjacent inband signals at the later stages for better receiver performance.



1st IF filters (6 kHz, 3 kHz)

USB Connector for PC Control

The IC-9100 has a standard type B USB connector and can be connected to a PC. Modulation input, audio output, RTTY demodulator output and CI-V command can be controlled via the USB cable.

Other Features

- 32-bit DSP and double conversion superheterodyne system
- AGC loop management
- Digital IF filter
- Digital twin PBT and IF shift
- Noise reduction
- Noise blanker
- RF speech compressor
- Adjustable transmit bandwidth
- RTTY demodulator and decoder
- Ample CW functions
- Built-in antenna tuner for HF/50 MHz band
- Digital notch filter
- Large, multi-function LCD
- Optional CS-9100 programming software
- Optional RS-BA1 IP remote control software

Handheld Transceivers

DIGITAL



VHF/UHF DIGITAL TRANSCEIVER **ID-51E PLUS2**

V/V, U/U, V/U Dualwatch

Independent AM/FM Receiver

Terminal Mode and
Access Point Mode

Lightweight & Compact Body

The ID-51E PLUS2 has a compact 58 × 105.4 × 26.4 mm body, and weighs only 255 g (approx.) with battery pack and antenna. In this slim body, the ID-51E PLUS2 contains 5 W output power, VHF/UHF dual band, D-STAR and integrated GPS receiver.



V/V, U/U, V/U Dualwatch

The dualwatch function monitors VHF/VHF, UHF/UHF and VHF/UHF bands simultaneously.* The audio and squelch levels can be set separately for the main and sub-bands.

*DV/DV, AM/AM, FM-N/FM-N and DV/FM-N modes dualwatch not available.

Terminal Mode*

Connect the ID-51E PLUS2 to the Internet through a PC or Android™ device, and send your voice and/or data through the Internet gateway to a destination repeater.

* The optional free download software, RS-MS3W/RS-MS3A is required to be installed in the PC/ Android™ device. The optional data cable OPC-2350LU is required.



Access Point Mode*

Use an ID-51E PLUS2 radio connected to the Internet through a PC or Android™ device, as an Access point. You can use another D-STAR radio to send your voice and/or data through the Access point radio, and communicate with D-STAR stations all over the world.

* The optional free download software, RS-MS3W/RS-MS3A is required to be installed in the PC/ Android™ device. The optional data cable OPC-2350LU is required.



Integrated GPS Receiver

The integrated GPS receiver provides fast start-up time and accurate position. Your current position and altitude are shown on the display and offers a position reporting function in DV mode. The GPS-A mode assists in easy D-PRS operation.



GPS receiver transparent image

DV Fast Data Mode*

By using data in place of voice frames, the ID-51E PLUS2 transfers data 3.5 times faster (3480 bps) than in the conventional DV mode (with voice). Pictures taken by an Android™ device can be quickly transmitted in the DV Fast Data mode.

* The DV Fast Data mode is not compatible with the DV mode low-speed data communication.

DV/FM Repeater Search Function

The repeater search function searches for nearby analog FM repeaters as well as DV repeaters using the repeater memories and the integrated GPS*.

* To use the repeater search function, the position data of the repeater is required.

Independent AM/FM Receiver

FM and AM broadcast and VHF airband stations can be listened to while using the dualwatch function to monitor the ham bands.



AM + dualwatch receive

microSD Card Slot

When used with a microSD card (up to 32 GB), various contents including voice memory, DV auto reply message, TX voice message, QSO log, RX history log and GPS log data can be stored. The microSD card can also be used to update firmware and edit memories.

Automatic Reply Function (DV Mode)

When receiving a call addressed to your callsign, the ID-51E PLUS2 can automatically reply your current position information*. Between ID-51E PLUS2's communication, replied position information can pop up on the caller's display.

*Function not available on all D-STAR networks.

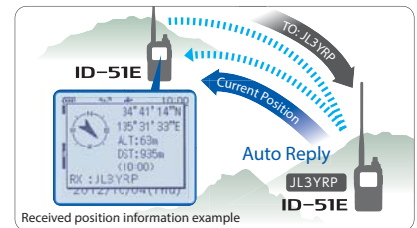

Received position information example

IPX7 Waterproof Construction

The ID-51E PLUS2 has superior IPX7 waterproof protection (1 m depth of water for 30 minutes). It can be used in harsh outdoor environments, or when hiking, mountain biking, touring and doing mountain sports.



RS-MS1A Remote Control Software (Free download Android™ application)

The RS-MS1A allows you to connect to the ID-51E PLUS2 and remotely set DR functions, link with a map application and send/receive messages over the DV mode.

* Optional OPC-2350LU USB cable is required.

Other Features

- 5 W output power
- 3 hours rapid charging with supplied wall charger (BP-271)
- Long lasting battery pack
- CS-51 PLUS2 cloning software supplied
- Dplus Reflector link commands

Digital Repeaters

ID-RP2C Repeater controller	ID-RP2D 1.2GHz DD mode module	ID-RP2V 1.2GHz DV mode module	ID-RP2000V 144MHz DV mode module	ID-RP4000V 430MHz DV mode module	RS-RP3C Internet gateway software

DIGITAL



VHF/UHF DIGITAL TRANSCEIVER ID-5100E

Intuitive Touch Screen Operation

DV/DV Dualwatch

Integrated GPS Receiver



DV/FM Repeater Search Function

The DV/FM repeater search function assists you in accessing nearby repeaters, even in areas you are visiting for the first time. The function searches for a nearby repeater using the repeater memories with the GPS position information.

* To use the repeater search function, the position data of the repeater is required.

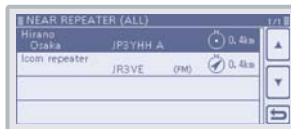

Repeater list example

DV Fast Data Mode*

By using data in place of voice frames, the ID-5100E can transfer data 3.5 times faster (3480 bps) than in the conventional DV mode (with voice).

* The DV Fast Data mode is not compatible with the DV mode low-speed data communication.

RS-MS1A Remote Control (Free download Android™ application)

The RS-MS1A allows you wirelessly connect to the ID-5100E and remotely set DR functions, link with a map application and send/receive messages over the DV mode. In addition, pictures taken by the Android™ device can be transmitted in the DV Fast Data mode or DV mode.

* Optional UT-133/A Bluetooth® unit must be installed in the ID-5100E.

* Some functions may not work properly, depending on Android™ phones and devices used.

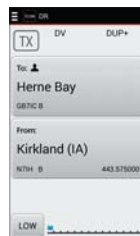

DR function setting example



Repeater map example © Google

Dplus Reflector Linking

Dplus reflector link commands are added to the DR function to allow easy reflector operation. Use Reflector, link/unlink to Reflector, echo test and repeater information commands are selectable.

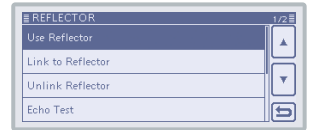

Reflector commands example

SD Card Slot for Voice and Data Storage

When used with an SD card, the SD card can store various contents including voice memory, DV auto reply message, TX voice message, QSO log, RX history log and GPS log data. Memory channels, repeater memories and other personal settings can be saved to the SD card and can be loaded to the transceiver.



SD card slot

VS-3 Bluetooth® Headset

The optional Bluetooth® headset, VS-3, provides hands-free communication and can remotely control the ID-5100E with three programmable buttons. This provides convenient communication in a vehicle.

* Optional UT-133/A Bluetooth® unit must be installed in the ID-5100E.

Bluetooth® application image

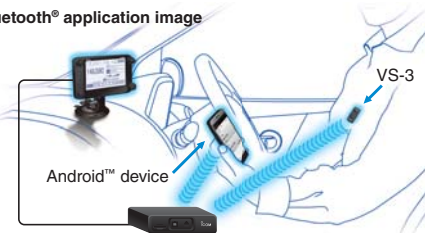

Intuitive Touch Screen Operation

The intuitive touch screen interface provides quick and smooth operation. The large 5.5 inch display (320 x 128 pixels) responds naturally to the touch – allowing you to change settings, enter frequencies and edit memory channels with ease.



Vehicle installation example (Using optional MBF-1 mount base and MBA-2 controller bracket)

DV/DV Dualwatch

The ID-5100E can receive both FM/FM and FM/DV mode signals simultaneously. Two DV mode signals can be monitored for receive on either channel. You can check other repeaters or other channel activities while waiting for the main repeater.

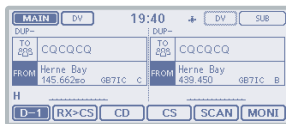

DV/DV dualwatch (DR function) example

* Main band audio has priority if two DV signals come in at the same time.

Integrated GPS Receiver

The ID-5100E has an integrated GPS receiver in the controller and shows own position, course, speed and altitude on the display. The GPS position information can be used for exchanging position reports, tracing the GPS log and searching for nearby repeater sites.

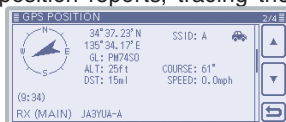

Received position information example

Other Features

- 50 W output power
- Repeater memory channels increased to 1500
- CTCSS and DTCS with Split tone function
- Sub band mute auto
- D-PRS functions
- Convenient memory contents management using CSV format
- Speech function announces operating frequency, mode and received call sign (DV mode)
- Independent main, volume and SQL knobs for A/B bands
- AM airband dualwatch
- CS-5100, programming software supplied
- 1750 Hz tone burst

Firmware Update Available (Free Download)
<http://www.icom.co.jp/world/support/index.html>

Steps to send a picture over the DV mode (Use with the RS-MS1A)



Mobile Transceivers



Selectable LCD/key backlight colour



DR (D-STAR Repeater) Function

The DR function makes D-STAR communications simple. By simply selecting a destination call sign in "To", and your access repeater in "From", you can talk with other D-STAR users.

Easy-to-Read Full Dot-Matrix Display

To increase the amount of display information, a full dot-matrix display is used in the ID-4100E.



GPS position information

Repeater list

DV/FM Near Repeater Search Function

The DV/FM near repeater search function assists you in accessing nearby repeaters, even in areas you are visiting for the first time.

Other Features

- Applications for iOS™ (RS-MS11) and Android™ (RS-MS1A) devices
- Wireless audio with optional UT-137 Bluetooth® unit
- DV fast data mode
- microSD card slot
- Integrated GPS receiver
- Wide band receiver (118–174 and 230–550 MHz)*
- The QUICK key allows instant access to menus listing dedicated functions
- Memory/Bank scan, Full scan, Band scan, Program scan, Program link scan, Duplex scan, Tone scan and DR scan
- 16 channels of DTMF memory (24-digit)
- CTCSS/DTCS signaling with the split tone functions (analog mode)
- 8.33 kHz air band channel reception

* Receiver range differs depending on version.

VHF/UHF DIGITAL TRANSCEIVER

ID-4100E

Terminal Mode and Access Point Mode

Compact, Detachable Controller for Flexible Installation

DR Function with the Latest Icom User Interface

Terminal/Access Point Mode*

Terminal and Access Point modes* enable you to enjoy long-distance D-STAR communication through the Internet. You can access the D-STAR repeater network through the Internet, regardless of locations and conditions of nearby repeaters.

* An optional free download software, RS-MS3W/RS-MS3A is required to be installed in the PC/Android™ device. Please see p.10 for function details.

Compact, Detachable Controller for Flexible Installation

The controller can be attached or detached from the main unit for flexible installation. By using the supplied OPC-837 controller cable, you can install the controller up to 3.5 meters away from the main unit.



Optional VS-3 Bluetooth® Headset

The optional VS-3 Bluetooth® headset can wirelessly control the IC-2730E with three programmable keys and a PTT button. It also provides VOX operation for hands-free communication.

* Optional UT-133/A Bluetooth® unit must be installed in the IC-2730E.

Easy Controller Mounting with the Optional MBF-1

The combination of the optional MBF-1 suction cup mounting base and MBA-5 controller bracket provides easy tilt and swivel adjustments. The large suction cup can be mounted on flat surfaces and can be removed easily.

Other Features

- Controller attachment to the main unit with optional MBA-4
- 50 W of output on VHF/UHF
- Built-in CTCSS and DTCS tones with split tone functions
- Wide band receiver (118–174 and 375–550 MHz)*
- HM-207 remote control microphone
- CS-2730 Free download PC programming software
- Versatile scanning capability
- Squelch delay and squelch attenuator
- Sub band auto mute function
- Sub band busy beep function
- Auto power off
- 16 DTMF auto dial memories
- CI-V remote control capability (through the OPC-478UC)

* Receiver range differs depending on version.

VHF/UHF DUAL BAND TRANSCEIVER

IC-2730E

50 Watts of Output Power on Both VHF and UHF Bands

VHF/VHF, UHF/UHF Simultaneous Receive

Optional Wireless Remote Control Bluetooth® Headset VS-3

VHF/VHF, UHF/UHF Simultaneous Receive

The IC-2730E provides VHF/VHF, UHF/UHF simultaneous receive capability as well as VHF/UHF receive. Simple one-touch of a button allows you to change between the main (transmit) band and sub band.

Independent Controls for Each Band

Operating two bands simultaneously is very simple with the symmetric layout with a wide LCD display showing both band settings in an easy to read side by side format. Various operation including frequency tuning can be made smoothly and straight-forwardly.

OPTIONS FOR BASE STATION TRANSCEIVERS





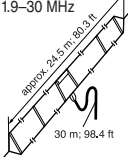

MODEL NAME	HAND MICROPHONES					DESKTOP MICROPHONES			EXTERNAL SPEAKER
	HM-36	HM-219	HM-103	HM-151	HM-198	SM-50	SM-30	SM-27	SP-23 4 audio filters
IC-7851	✓					✓	✓		
IC-7610	✓	✓				✓	✓		✓
IC-7700	✓	✓				✓	✓		
IC-7300	✓	✓				✓	✓		✓
IC-7410	✓	✓				✓	✓		✓
IC-718	✓	✓				✓	✓	✓	✓
IC-7100	(Use with OPC-589)	(Use with OPC-589)	✓	✓	✓	(Use with OPC-589)	(Use with OPC-589)		
IC-9100	✓	✓				✓	✓		✓





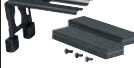

MODEL NAME	EXTERNAL SPEAKERS			DC POWER SUPPLY	ANTENNA ELEMENT	ANTENNA TUNERS		AUTO TUNING ANTENNA	NVIS KIT
	SP-33 Wooden box speaker	SP-34 4 audio filters	SP-35 2 m cable SP-35L 6 m cable	PS-126 13.8 V/25 A 4-pin type	AH-2b Covers 7–54 MHz	AH-4 Covers 3.5–54 MHz	AT-180 Covers 1.8–54 MHz	AH-740 Covers 2.5–30 MHz. (amateur band) OPC-2321 is required.	AH-5NV Fiberglass antenna element for use with AH-740. Covers 2.2–30MHz (amateur band) with AH-740.
IC-7851	✓	✓							
IC-7610	✓	✓	(Use SP-35L)	✓	✓	✓		(Use with OPC-2321)	✓
IC-7700	✓	✓							
IC-7300	✓	✓	✓	✓	✓	✓		(Use with OPC-2321)	✓
IC-7410				✓	✓	✓		(Use with OPC-2321)	✓
IC-718				(Depending on version)	✓	✓	✓	(Use with OPC-2321)	✓
IC-7100			(Use SP-35)	✓	✓	✓	✓	(Use with OPC-2321)	✓
IC-9100				✓	✓	✓		(Use with OPC-2321)	✓

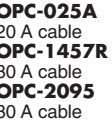
MODEL NAME	CONTROL CABLE	FOLDED DIPOLE ANTENNA	FILTERS			HIGH STABILITY CRYSTAL UNIT	DSP UNIT	LINEAR AMPLIFIER	CARRYING HANDLES
	OPC-2321 (6m) For use with AH-740 OPC-420 (10m) For use with AH-4.	AH-710 Covers 1.9–30 MHz 	FL-430 6 kHz 1st IF FILTER (For HF/ 50 MHz band)	FL-431 3 kHz 1st IF FILTER (For HF/50 MHz band)	FL-53A 250 Hz/–6 dB FL-222 1.8 kHz/–6 dB FL-257 3.3 kHz/–6 dB	CR-338 Frequency sta- bility: ±0.5 ppm	UT-106	IC-PW1EURO	MB-23 MB-121 MB-123
IC-7851									
IC-7610	✓	✓						✓	(Use MB-121)
IC-7700								✓	
IC-7300	✓	✓						(Use with OPC-599)	(Use MB-123)
IC-7410	✓	✓	✓	✓				(Use with OPC-599)	(Use MB-123)
IC-718	✓	✓				✓	✓	(Use with OPC-599)	(Use MB-23)
IC-7100	✓				(Accepts only one filter)		(Installed depending on version)	(Use with OPC-599)	
IC-9100	✓		✓	✓				(Use with OPC-599)	(Use MB-123)

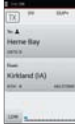
☑ : Applicable ☐ : Not applicable

OPTIONS FOR BASE STATION TRANSCEIVERS

MODEL NAME	MOBILE MOUNTING BRACKETS		MOUNTING BASE	CONTROLLER BRACKET	SEPARATION CABLES	MIC ADAPTER CABLE	ADAPTER CABLE	DC POWER CABLES
	MB-62 	MB-118 	MBF-1 	MBA-1 	OPC-2253 3.5 m OPC-2254 5.0 m 	OPC-589 8-pin connector microphone to 8-pin modular 	OPC-599 13-pin ACC socket to 7-, 8-pin ACC sockets 	OPC-025A 20 A cable OPC-1457R 30 A cable OPC-2095 30 A cable 
IC-7851								
IC-7610								✓ (Use OPC-2095)
IC-7700								
IC-7300		✓					✓	✓ (Use OPC-1457R)
IC-7410							✓	✓ (Use OPC-2095)
IC-718		✓					✓	✓ (Use OPC-025A)
IC-7100	✓		✓ (Use with MBA-1)	✓	✓	✓	✓	✓ (Use OPC-2095)
IC-9100							✓	✓ (Use OPC-2095)

MODEL NAME	PROGRAMMING SOFTWARE		REMOTE CONTROL SOFTWARE	IP REMOTE CONTROL SOFTWARE	USB REMOTE ENCODER	DIGITAL UNIT	DATA COMMUNICATION CABLES	
	CS-9100 A USB cable (A-B type) is required for programming.	CS-7100	RS-MS1A *1 	RS-BA1 	RC-28 	UT-121 	OPC-1529R RS-232 cable for an external GPS or a PC 	OPC-2350LU USB cable for an Android™ device or a PC 
IC-7851				✓	✓ (Use with RS-BA1)			
IC-7610				✓	✓			
IC-7700				✓	✓ (Use with RS-BA1)			
IC-7300				✓	✓ (Use with RS-BA1)			
IC-7410				✓	✓ (Use with RS-BA1)			
IC-718								
IC-7100		✓	✓ (Use with OPC-2350LU)	✓	✓ (Use with RS-BA1)		✓	✓
IC-9100	✓			✓	✓ (Use with RS-BA1)	✓	✓	

*1 Free download Android™ app. Download from Google Play™.

: Applicable : Not applicable

IP REMOTE CONTROL SOFTWARE RS-BA1



- Option for IC-7851, 7610, 7700, 7300, 7410, 7100 and 9100
- Most functions and modes of your transceiver can be remotely controlled over an IP network
- Low voice latency, high quality audio
- Waterfall spectrum scope can be observed (only for IC-7851, 7610 and 7300 single band)
- New slider control screen (e.g. RF power, CW pitch, twin PBT)
- Wake-up from standby mode via the RS-BA1 (for IC-7851, 7610, 7700, 7300 and 7100)
- Optional RC-28 provides a hardware dial/transmit function

Software Update Available (Free Download)
<http://www.icom.co.jp/world/support/index.html>







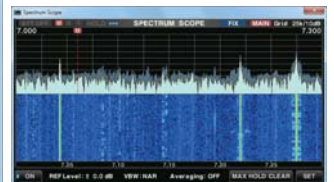



Slider controls

USB REMOTE ENCODER
RC-28









Waterfall spectrum scope

OPTIONS FOR HANDHELD TRANSCEIVERS

	BATTERY CASES	BATTERY PACKS		DESKTOP CHARGER	AC ADAPTER	WALL CHARGER	CIGARETTE LIGHTER CABLES		DC POWER CABLES
MODEL NAME	BP-273 LR6(AA)×3 cells	BP-271 (Li-ion) 7.4V/1150mAh(min.), 1200 mAh(typ.)	BP-272 (Li-ion) 7.4V/1880mAh(min.), 2000 mAh(typ.)	BC-202 Rapid charger	BC-123SE 12 V/1A	BC-167SD 12 V/500 mA	CP-12L with noise filter	CP-19R with DC-DC converter	OPC-254L
									
ID-51E PLUS2	✓	✓	✓	✓ (Use with BC-123SE)	✓	✓	✓	✓	✓

	SPEAKER-MICROPHONES			EARPHONE-MICROPHONES		HEADSETS			PLUG ADAPTER CABLE
MODEL NAME	HM-75LS	HM-183LS Waterproof	HM-186LS	HM-153LS	HM-153	HS-94 Earhook type with boom microphone	HS-95 Behind-the-head type	HS-97 Throat microphone type	OPC-2006LS
									
ID-51E PLUS2	✓	✓	✓	✓	✓ (Use with OPC-2144)	✓ (Use with OPC-2006LS)	✓ (Use with OPC-2006LS)	✓ (Use with OPC-2006LS)	✓

	PLUG ADAPTER CABLE	CARRYING CASE	SILICONE JACKET CASE	DATA CABLE	BELT CLIP	ANTENNA	ANTENNA ADAPTER	PROGRAMMING SOFTWARE	REMOTE CONTROL APP
MODEL NAME	OPC-2144	LC-179	SJ-1 For use with BP-271	OPC-2350LU USB cable for an Android™ device or a PC	MB-127 Alligator type	FA-S270C VHF/UHF stand- ard antenna	AD-92SMA BNC type antenna connector	CS-51 PLUS2 *1	RS-MS1A ** For Android™ device
									
ID-51E PLUS2	✓	✓	✓	✓	✓	✓	✓	✓	✓ (Use with OPC-2350LU)

*1 CS-51 PLUS2 is available for free download from: <http://www.icom.co.jp/world/support/index.html>

**2 Free download Android™ app. Download from Google Play™.

	TERMINAL/ACCESS POINT MODE APP/SOFTWARE	
MODEL NAME	RS-MS3A ** For Android™ device	RS-MS3W ** For Windows® PC
ID-51E PLUS2	✓ (Use with OPC-2350LU)	✓ (Use with OPC-2350LU)

: Applicable : Not applicable

*3 Free download software for Windows® PC. Download from the Icom website:
<http://www.icom.co.jp/world/support/download/firm/>

Note for the Terminal mode and Access point mode:

- An Internet IP connection is necessary for a PC (Windows®) or Android™ device. (Either a dynamic or static IP address can be used.)
- Before you set up the Access point, check any regulations or laws in your country.
- Only one D-STAR transceiver can transmit through an Access point at a time.
- For the Access point or Terminal mode operation, you must register your MY and Access point call signs with a Gateway repeater/server that has the RS-RP3C installed.

OPTIONS FOR MOBILE TRANSCEIVERS

MODEL NAME	HAND MICROPHONES					BLUETOOTH® HEADSET	MOUNTING BASE	MOUNTING BRACKET	CONTROLLER BRACKET
	HM-198	HM-209 Noise canceling microphone	HM-207 HM-207S	HM-154	HM-232	VS-3	MBF-1	MBF-4	MBA-2
ID-5100E	✓	✓	(Use HM-207)	✓	✓	(Use with UT-133/A)	(Use with MBA-2)	✓	✓
ID-4100E	✓	✓	(Use HM-207S)	✓	✓	(Use with UT-137)	(Use with MBA-8)	✓	
IC-2730E	✓	✓	(Use HM-207)	✓	✓	(Use with UT-133/A)	(Use with MBA-5)		

MODEL NAME	CONTROLLER BRACKETS	COMBINATION BRACKET	EXTERNAL SPEAKERS		MICROPHONE CABLES	MIC ADAPTER CABLE	CONTROLLER CABLE	DATA CABLE
	MBA-8	MBA-5	MBA-4	SP-35 2 m cable SP-35L 6 m cable	SP-30 4 inch (102.5 mm) diameter speaker	OPC-440A 5.0 m OPC-647 2.5 m	OPC-589 8-pin connector microphone to 8-pin modular	OPC-1156 3.5 m
ID-5100E				✓	✓	✓	✓	✓
ID-4100E	✓			✓	✓	✓	✓	✓
IC-2730E		✓	✓	✓	✓	✓	✓	

MODEL NAME	DATA CABLES	PROGRAMMING CABLES	CLONING CABLE	BLUETOOTH® UNITS		PROGRAMMING SOFTWARES	TERMINAL/ACCESS POINT MODE APP/SOFTWARE	REMOTE CONTROL APP
	OPC-2350LU USB cable for an Android™ or a PC	OPC-478UC Transceiver to PC USB cable	OPC-474 Between transceivers	UT-133/A	UT-137	CS-2730* ¹ CS-4100* ¹ CS-5100* ¹	RS-MS3A* ² For Android™ device RS-MS3W* ³ For Windows® PC	RS-MS1A* ² For Android™ device
ID-5100E	✓	✓		✓		(Use CS-5100)		(Use with UT-133/A)
ID-4100E	✓	✓			✓	(Use CS-4100)	(Use with OPC-2350LU) (Use with OPC-2350LU)	(Use with UT-137)
IC-2730E		✓	✓	✓		(Use CS-2730)		

*1 CS-5100, CS-4100 and CS-2730 are available for free download from Icom website:
<http://www.icom.co.jp/world/support/index.html>

*2 Free download Android™ app. Download from Google Play™.

*3 Free download software for Windows® PC. Download from the Icom website:
<http://www.icom.co.jp/world/support/download/firm/>

Note for the Terminal mode and Access point mode:

- An Internet IP connection is necessary for a PC (Windows®) or Android™ device. (Either a dynamic or static IP address can be used.)
- Before you set up the Access point, check any regulations or laws in your country.
- Only one D-STAR transceiver can transmit through an Access point at a time.
- For the Access point or Terminal mode operation, you must register your MY and Access point call signs with a Gateway repeater/server that has the RS-RP3C installed.

MODEL NAME	REMOTE CONTROL APP
	RS-MS11* ⁴ For iOS™ device
ID-5100E	
ID-4100E	✓ (Use with UT-137)
IC-2730E	

*4 Free download iOS™ app. Download from the App Store.

RS-MS1A/RS-MS1I Remote Control App

(Free Download Android™/iOS™ Application from Google Play™/App Store)

The RS-MS1A and RS-MS1I allow you to connect the Digital transceiver with an Android™/iOS™ device and remotely control various functions and settings from the Android™/iOS™ device. You can take pictures with your iOS™ or Android™ device, or use stored pictures, and share them over the DV mode.

* An optional Bluetooth® unit (UT-133/A or UT-137) or a data cable (OPC-2350LU) is required. Not all functions are usable with the IC-7100.

* Some functions may not work properly, depending on Android™/iOS™ phones and devices used.

* Photo shows RS-MS1A.

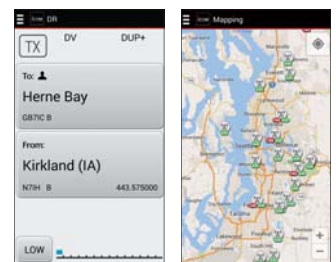

DR function setting example

Repeater map example © Google

✓ : Applicable □ : Not applicable

SPECIFICATIONS FOR BASE STATION TRANSCEIVERS

		IC-7851	IC-7610	IC-7700	IC-7300
General	Frequency coverage <small>(Differs according to version)</small>	Tx: 135 kHz, 1.8, 3.5, 7, 10, 14, 18, 21, 24, 28, 50MHz bands Rx: 30 kHz–60 MHz* * Some frequency ranges are not guaranteed.	Tx: 1.8, 3.5, 7, 10, 14, 18, 21, 24, 28, 50MHz bands Rx: 30 kHz–60 MHz* * Some frequency ranges are not guaranteed	Tx: 1.8, 3.5, 7, 10, 14, 18, 21, 24, 28, 50 MHz bands Rx: 30 kHz–60 MHz* * Some frequency ranges are not guaranteed.	Tx: 1.8, 3.5, 7, 10, 14, 18, 21, 24, 28, 50, 70*1 MHz bands Rx: 30 kHz–74.8 MHz*2 *1 Depending on version. *2 Some frequency ranges are not guaranteed.
	Modes	USB, LSB, CW, RTTY, PSK31/63, AM, FM	USB, LSB, CW, RTTY, PSK31/63, AM, FM	USB, LSB, CW, RTTY, PSK31, AM, FM	USB, LSB, CW, RTTY, AM, FM
	Frequency stability	Less than ±0.05 ppm (0°C to +50°C; @ 54 MHz, after warm up)	Less than ±0.5 ppm (0°C to +50°C)	±0.05 ppm (0°C to +50°C, after warm up)	Less than ±0.5 ppm (–10°C to +60°C)
	Maximum current drain	800 VA (85–265 V AC)	23 A at 13.8 V DC	800 VA (85–265 V AC)	21 A at 13.8 V DC
	Antenna connector	SO-239 × 4 + BNC × 2 (50 Ω)	SO-239 × 2 + BNC (50 Ω)	SO-239 × 4 + BNC (50 Ω)	SO-239 (50 Ω)
	Dimensions <small>(W × H × D, Projections are not included)</small>	425 × 149 × 435 mm	340 × 118 × 277 mm	425 × 149 × 437 mm	240 × 94 × 238 mm
	Weight (approx.)	23.5 kg	8.5 kg	22.5 kg	4.2 kg
Transmitter	Output power	SSB, CW, RTTY, PSK, FM: 5–200 W AM: 5–50 W	SSB, CW, RTTY, PSK, FM: 1–100 W AM: 1–25 W	SSB, CW, RTTY, PSK31, FM: 5–200 W AM: 5–50 W	SSB, CW, FM, RTTY: HF/50 MHz 2–100 W 70 MHz 2–50 W AM: HF/50 MHz 1–25 W 70 MHz 1–12.5 W
	Sensitivity (typical) <small>Preamp ON SSB, CW, RTTY, AM: at 10 dB S/N FM, WFM: at 12 dB SINAD</small>	SSB, CW, RTTY, PSK (2.4 kHz): 0.1–1.799 MHz 0.5 µV 1.8–29.999 MHz 0.16 µV 50–54 MHz 0.13 µV AM (6 kHz): 0.1–1.799 MHz 6.3 µV 1.8–29.999 MHz 2.0 µV 50–54 MHz 1.0 µV FM (15 kHz): 28–29.700 MHz 0.5 µV 50–54 MHz 0.32 µV	SSB, CW (2.4 kHz): 1.8–29.999 MHz 0.16 µV 50–54 MHz 0.13 µV AM (6 kHz): 0.1–1.799 MHz 6.3 µV 1.8–29.999 MHz 2.0 µV 50–54 MHz 1.0 µV FM (15 kHz): 28–29.7 MHz 0.5 µV 50–54 MHz 0.32 µV	SSB, CW, RTTY (2.4 kHz): 0.1–1.799 MHz 0.5 µV 1.8–29.990 MHz 0.16 µV 50–54MHz 0.13 µV AM (6 kHz): 0.1–1.799 MHz 6.3 µV 1.8–29.990 MHz 2.0 µV 50–54 MHz 1.0 µV FM (15 kHz): 28–29.999 MHz 0.5 µV 50–54 MHz 0.32 µV	SSB, CW (2.4 kHz): 1.8–29.999 MHz 0.16 µV 50–54 MHz 0.13 µV 70–70.5 MHz 0.16 µV AM (6 kHz): 0.5–1.8 MHz 12.6 µV 1.8–29.999 Hz 2.0 µV 50–54 MHz 1.0 µV 70–70.5 MHz 1.0 µV FM (15 kHz): 28–29.7 MHz 0.5 µV 50–54 MHz 0.25 µV 70–70.5 MHz 0.25 µV
Receiver	Sensitivity for RED <small>(Less than)</small> <small>Preamp ON SSB, AM, FM: at 12 dB SINAD</small>	SSB (2.4 kHz): 1.8–2.999 MHz 10 dBµV emf 3.0–29.999 MHz 0 dBµV emf 50 MHz band –6 dBµV emf AM (4 kHz, 60% modulation): 1.8–2.999 MHz 16 dBµV emf 3.0–29.999 MHz 6 dBµV emf 50 MHz band 0 dBµV emf FM (7 kHz, 60% modulation): 28–29.700 MHz 0 dBµV emf 50 MHz band –6 dBµV emf	SSB (2.4 kHz): 1.8–2.999 MHz 10 dBµV emf 3.0–29.999 MHz 0 dBµV emf 50 MHz band –6 dBµV emf AM (4 kHz, 60% modulation): 1.8–2.999 MHz 16 dBµV emf 3.0–29.999 MHz 6 dBµV emf 50 MHz band 0 dBµV emf FM (7 kHz, 60% modulation): 28–29.700 MHz 0 dBµV emf 50 MHz band –6 dBµV emf	SSB (2.4 kHz): 1.8–2.999 MHz 10 dBµV emf 3.0–29.990 MHz 0 dBµV emf 50 MHz band –6 dBµV emf AM (4 kHz, 60% modulation): 1.8–2.999 MHz 16 dBµV emf 3.0–29.990 MHz 6 dBµV emf 50 MHz band 0 dBµV emf FM (7 kHz, 60% modulation): 28–29.990 MHz 0 dBµV emf 50 MHz band –6 dBµV emf	SSB (2.4 kHz): 1.8–2.999 MHz 10 dBµV emf 3.0–29.999 MHz 0 dBµV emf 50/70 MHz band –6 dBµV emf AM (4 kHz, 60% modulation): 1.8–2.999 MHz 16 dBµV emf 3.0–29.999 MHz 6 dBµV emf 50/70 MHz band 0 dBµV emf FM (7 kHz, 60% modulation): 28–29.700 MHz 0 dBµV emf 50/70 MHz band –6 dBµV emf
	Selectivity	SSB: 2.4 kHz/–3 dB (2.4 kHz) 3.6 kHz/–60 dB CW/RTTY/PSK: 500 Hz/–3 dB (500 Hz) 700 Hz/–60 dB AM: 6.0 kHz/–3 dB (6 kHz) 15 kHz/–60 dB FM: 12 kHz/–6 dB (15 kHz) 20 kHz/–60 dB * Variable between 50 Hz and 3.6 kHz.	SSB: 2.4 kHz/–6 dB (2.4 kHz) 3.6 kHz/–60 dB CW: 500 Hz/–6 dB (500 Hz) 700 Hz/–60 dB RTTY: 500 Hz/–6 dB (500 Hz) 700 Hz/–60 dB AM: 6.0 kHz/–6 dB (6 kHz) 15 kHz/–60 dB FM: 12 kHz/–6 dB (15 kHz) 20 kHz/–60 dB * Variable between 50 Hz and 3.6 kHz.	SSB: 2.4 kHz/–3 dB (2.4 kHz) 3.6 kHz/–60 dB CW: 500 Hz/–3 dB (500 Hz) 700 Hz/–60 dB RTTY, PSK31: 360 Hz/–6 dB (350 Hz) 650 Hz/–60 dB AM: 6.0 kHz/–3 dB (6 kHz) 15 kHz/–60 dB FM: 12 kHz/–6 dB (15 kHz) 20 kHz/–60 dB * Variable between 50 Hz and 3.6 kHz.	SSB: 2.4 kHz/–6 dB (2.4 kHz) 3.4 kHz/–40 dB CW: 500 Hz/–6 dB (500 Hz) 700 Hz/–40 dB RTTY: 500 Hz/–6 dB (500 Hz) 800 Hz/–40 dB AM: 6.0 kHz/–6 dB (6 kHz) 10 kHz/–40 dB FM: 12 kHz/–6 dB (15 kHz) 22 kHz/–40 dB * Variable between 50 Hz and 3.6 kHz.
	Spurious and image rejection	More than 70 dB	HF More than 70 dB 50 MHz More than 70 dB* * Except for ADC Aliasing	More than 70 dB	HF More than 70 dB 50/70 MHz More than 70 dB* * Except for ADC Aliasing
	Audio output power <small>(at 10% distortion with an 8 Ω load)</small>	More than 2.6 W	More than 2.0 W	More than 2.6 W	More than 2.5 W

The LCD display may have cosmetic imperfections that appear as small or dark spots. This is not a malfunction or defect, but a normal characteristic of LCD displays.
All stated specifications are subject to change without notice or obligation.

SPECIFICATIONS FOR BASE STATION TRANSCEIVERS

		IC-7410	IC-718	IC-7100	IC-9100
General	Frequency coverage <small>(Differs according to version)</small>	Tx: 1.8, 3.5, 7, 10, 14, 18, 21, 24, 28, 50 MHz bands Rx: 30 kHz–60.000 MHz* * Some frequency ranges are not guaranteed.	Tx: 1.8, 3.5, 7, 10, 14, 18, 21, 24, 28 MHz bands Rx: 30 kHz–29.999 MHz* * Guaranteed range 0.5–29.999 MHz.	Tx: 1.8, 3.5, 7, 10, 14, 18, 21, 24, 28, 50, 70*1, 144, 430 MHz bands Rx: 30 kHz–199.999 MHz, 400–470 MHz*2 *1 Depending on version. *2 Some frequency ranges are not guaranteed	Tx: 1.8, 3.5, 7, 10, 14, 18, 21, 24, 28, 50, 144, 430 MHz bands Rx: 30 kHz–60 MHz*, 144–146 MHz, 430–440 MHz * Some frequency ranges are not guaranteed.
	Modes	USB, LSB, CW, RTTY, AM, FM	USB, LSB, CW, RTTY, AM	USB, LSB, CW, RTTY, DV, AM, FM, WFM* (*Rx only)	USB, LSB, CW, RTTY (FSK), AM*FM, DV (with UT-121) * Transmit HF/50 MHz only.
	Frequency stability	Less than ±0.5 ppm (0°C to +50°C)	Less than ±200 Hz (From 1 min. to 60 min. after power ON)	±0.5 ppm (0°C to +50°C @ 430 MHz)	±0.5 ppm (0°C to +50°C, after warm up)
	Maximum current drain	23 A at 13.8 V DC	20 A at 13.8 V DC	22 A (HF/50/70 MHz), 16 A (144/430 MHz) at 13.8 V DC	24 A at 13.8 V DC
	Antenna connector	SO-239 × 2 (50 Ω)	SO-239 (50 Ω)	SO-239 × 2 (for HF/50/70 MHz and 144/430 MHz bands: 50 Ω)	HF/50 MHz SO-239 (50 Ω) × 2 144 MHz SO-239 (50 Ω) 430 MHz Type-N (50 Ω)
	Dimensions <small>(W × H × D, Projections are not included)</small>	315 × 116 × 343 mm	240 × 95 × 239 mm	Main unit: 167 × 58 × 225 mm Controller: 165 × 64 × 78.5 mm	315 × 116 × 343 mm
	Weight <small>(approx.)</small>	10.2 kg	3.8 kg	Main unit: 2.3 kg Controller: 500 g	11 kg
Transmitter	Output power	SSB, CW, RTTY, FM: 2–100 W AM: 2–27 W	SSB, CW, RTTY, FM: 2–100 W AM: 2–35 W	SSB, CW, RTTY, FM, DV: 1.8–50 MHz 2–100 W 70/144 MHz 2–50 W 430 MHz 2–35 W AM: 1.8–50 MHz 1–30 W 70 MHz 1–15 W	SSB, CW, RTTY, FM, DV*: HF/50 MHz 2–100 W 144 MHz 2–100 W 430 MHz 2–75 W AM: HF/50 MHz 2–30 W * With UT-121.
	Sensitivity <small>(typical)</small> <small>Preamp ON SSB, CW, RTTY, AM: at 10 dB S/N FM, WFM: at 12 dB SINAD DV: at 1% BER</small>	SSB, CW (2.4 kHz): 1.8–29.999 MHz 0.16 µV 50–54 MHz 0.13 µV AM (6 kHz): 0.5–1.8 MHz 12.6 µV 1.8–29.999 MHz 2.0 µV 50–54 MHz 1.6 µV FM (15 kHz): 28–29.7 MHz 0.5 µV 50–54 MHz 0.32 µV	SSB, CW: 1.8–29.999 MHz 0.16 µV AM: 0.5–1.799 MHz 13 µV 1.8–29.999 MHz 2.0 µV	SSB, CW (2.4 kHz): 1.8–29.999 MHz 0.15 µV 50–54 MHz 0.12 µV 70–70.5 MHz 0.15 µV 144/430 MHz 0.11 µV AM: 0.5–1.8 MHz 13 µV (6 kHz) 1.8–29.999 MHz 2.0 µV 50/70/144/430 MHz 1.0 µV FM: 28–29.7 MHz 0.5 µV (15 kHz) 50/70 MHz 0.25 µV 144/430 MHz 0.18 µV DV: 28–29.7 MHz 1 µV 50/70 MHz 0.63 µV 144/430 MHz 0.35 µV WFM: 76–108 MHz 10 µV	SSB, CW (2.4 kHz): 1.8–29.999 MHz 0.16 µV 50–54 MHz 0.13 µV 144/430 MHz 0.11 µV AM: 0.5–1.8 MHz 12.6 µV (6 kHz) 1.8–29.999 MHz 2.0 µV 50–54 MHz 1.6 µV 144/430 MHz 1.4 µV FM: 28–29.7 MHz 0.5 µV (15 kHz) 50–54 MHz 0.32 µV 144/430 MHz 0.18 µV DV*: 28–29.7 MHz 1.0 µV 50–54 MHz 0.63 µV 144/430 MHz 0.35 µV * With UT-121.
Receiver	Sensitivity for RED <small>(Less than)</small> <small>Preamp ON SSB, AM, FM: at 12 dB SINAD</small>	SSB (2.4 kHz): 1.8–2.999 MHz 10 dBµV emf 3.0–29.999 MHz 0 dBµV emf 50 MHz band –6 dBµV emf AM (4 kHz, 60% modulation): 1.8–2.999 MHz 16 dBµV emf 3.0–29.999 MHz 6 dBµV emf 50 MHz band 0 dBµV emf FM (7 kHz, 60% modulation): 28–29.7 MHz 0 dBµV emf 50 MHz band –6 dBµV emf	SSB (2.4 kHz): 1.8–2.999 MHz 10 dBµV emf 3.0–29.999 MHz 0 dBµV emf AM (6 kHz, 60% modulation): 1.8–2.999 MHz 16 dBµV emf 3.0–29.999 MHz 6 dBµV emf	SSB (2.4 kHz): 1.8–2.999 MHz 10 dBµV emf 3.0–29.999 MHz 0 dBµV emf 50/70 MHz band –6 dBµV emf 144/430 MHz band –6 dBµV emf AM (4 kHz, 60% modulation): 1.8–2.999 MHz 16 dBµV emf 3.0–29.999 MHz 6 dBµV emf 50 MHz band 0 dBµV emf 144/430 MHz band 0 dBµV emf FM (7 kHz, 60% modulation): 28–29.700 MHz 0 dBµV emf 50 MHz band –6 dBµV emf 144/430 MHz band –6 dBµV emf (*Preamp OFF)	SSB (2.4 kHz): 1.8–2.999 MHz 10 dBµV emf 3.0–29.999 MHz 0 dBµV emf 50 MHz band –6 dBµV emf 144/430 MHz band –6 dBµV emf* AM (4 kHz, 60% modulation): 1.8–2.999 MHz 16 dBµV emf 3.0–29.999 MHz 6 dBµV emf 50 MHz band 0 dBµV emf 144/430 MHz band 0 dBµV emf* FM (7 kHz, 60% modulation): 28–29.700 MHz 0 dBµV emf 50 MHz band –6 dBµV emf 144/430 MHz band –6 dBµV emf* (*Preamp OFF)
	Selectivity	SSB: 2.4 kHz/–6 dB (2.4 kHz) 3.4 kHz/–40 dB CW: 500 Hz/–6 dB (500 Hz) 700 Hz/–40 dB RTTY: 500 Hz/–6 dB (350 Hz) 800 Hz/–40 dB AM: 6.0 kHz/–6 dB (6 kHz) 10 kHz/–40 dB FM: 12 kHz/–6 dB (15 kHz) 22 kHz/–40 dB * Variable between 50 Hz and 3.6 kHz.	SSB, CW, RTTY: 2.1 kHz/–6 dB 4.5 kHz/–60 dB AM: 6.0 kHz/–6 dB 20 kHz/–40 dB	SSB: 2.4 kHz/–6 dB (2.4 kHz) 3.4 kHz/–40 dB CW: 500 Hz/–6 dB (500 Hz) 700 Hz/–60 dB RTTY: 500 Hz/–6 dB (500 Hz) 800 Hz/–40 dB AM: 6.0 kHz/–6 dB (6 kHz) 10 kHz/–40 dB FM: 12 kHz/–6 dB (15 kHz) 22 kHz/–40 dB DV (12.5 kHz): –50 dB	SSB: 2.4 kHz/–6 dB (2.4 kHz) 3.4 kHz/–40 dB CW: 500 Hz/–6 dB (500 Hz) 700 Hz/–40 dB RTTY: 500 Hz/–6 dB (500 Hz) 800 Hz/–40 dB AM: 6.0 kHz/–6 dB (6 kHz) 10.0 kHz/–40 dB FM: 12 kHz/–6 dB (15 kHz) 22 kHz/–40 dB DV (With UT-121) : –50 dB (12.5kHz spacing)
	Spurious and image rejection <small>(except IF)</small>	More than 70 dB	More than 70 dB (1.8–29.999 MHz)	More than 70 dB (HF/50/70 MHz) More than 65 dB (144/430 MHz) (except 1/2 IF through on 50 MHz, IF through on 144 MHz)	HF/50 MHz More than 70 dB 144,430 MHz More than 60 dB
	Audio output power <small>(at 10% distortion with an 8 Ω load)</small>	More than 2.0 W	More than 2.0 W	More than 2.0 W	More than 2.0 W

All stated specifications are subject to change without notice or obligation.

SPECIFICATIONS FOR HANDHELD AND MOBILE TRANSCEIVERS

	ID-51E PLUS2	ID-5100E	ID-4100E	IC-2730E
Frequency coverage <small>(Differs according to version)</small>	Europe version: Tx 144-146, 430-440 MHz Rx (A) 144-146, 430-440 MHz (B) 144-146, 430-440 MHz (BC) 0.52-1.71, 76-108 MHz UK version: Tx 144-146, 430-440 MHz Rx (A) 137-174, 380-479 MHz*1 (B) 108-174, 380-479 MHz*1 (BC) 0.52-1.71, 76-108 MHz	Europe version : Tx 144-146, 430-440 MHz Rx 118-174, 375-550 MHz*1 Italia version : Tx 144-146, 430-434, 435-438 MHz Rx 118-136.991, 144-146, 430-434, 435-438 MHz*2	Europe version : Tx 144-146, 430-440 MHz Rx 118-174, 230-550 MHz*1 Italia version : Tx 144-146, 430-434, 435-438 MHz Rx 118-136.991, 144-146, 430-434, 435-438 MHz*2	Europe version : Tx 144-146, 430-440 MHz Rx 118-174, 375-550 MHz*1 Italia version : Tx 144-146, 430-434, 435-438 MHz Rx 118-136.991, 144-146, 430-434, 435-438 MHz*2
Modes	DV, FM, FM-N, AM (Rx only), WFM (Rx only)	DV, FM, FM-N, AM (Rx only), AM-N (Rx only)	DV, FM, FM-N, AM (Rx only), AM-N (Rx only)	FM, FM-N, AM (Rx only), AM-N (Rx only)
Max. current drain	2.5 A	13 A	13 A	13 A
Number of memory channels	554 (500 regular, 50 scan edges and 4 call channels)	1054 (1000 regular, 50 scan edges and 4 call channels)	1054 (1000 regular, 50 scan edges, 4 call channels,)	1052 (1000 regular, 50 scan edges and 2 call channels)
Dimensions <small>(W × H × D; Projections are not included)</small>	58 × 105.4 × 26.4 mm	Main unit: 150 × 40 × 172.6 mm Controller: 182.2 × 81.5 × 24.7 mm	Main unit + Controller: 150 × 40 × 171.9 mm Controller: 122 × 40 × 29.7 mm	Main unit: 150 × 40 × 151 mm Controller: 150 × 50 × 27.2 mm
Weight (approx.)	255 g with antenna and BP-271	Main unit: 1.3 kg Controller: 260 g	Main unit: 1.1 kg Controller: 100 g	Main unit: 1.2 kg Controller: 140 g
Output power <small>(typical values)</small>	High: 5 W Mid: 2.5 W Low2: 1.0 W Low1: 0.5 W S-Low: 0.1 W (at 7.4 V DC)	High: 50 W Mid: 15 W Low: 5 W (at 13.8 V DC)	High: 50 W Mid: 15 W Low: 5 W (at 13.8 V DC)	Main unit: 1.2 kg Controller: 140 g
Sensitivity <small>(FM: at 12dB SINAD DV: at 1% BER Guaranteed range)</small>	DV Less than 0.28 µV FM/FM-N Less than 0.18 µV (144, 430 MHz bands)	DV Less than 0.28 µV FM/FM-N Less than 0.18 µV (144, 430 MHz bands)	DV Less than 0.22 µV FM/FM-N Less than 0.18 µV (144, 430 MHz bands)	FM/FM-N Less than 0.18 µV (144, 430 MHz bands)
Audio output power <small>(at 10% distortion)</small>	More than 400 mW (Internal SP, 16 Ω load) More than 200 mW (Internal SP, 8 Ω load)	More than 2.0 W (8 Ω load)	More than 2.0 W (8 Ω load)	More than 2.0 W (8Ω load)

*1 Guaranteed range 144-146 and 430-440MHz. *2 Guaranteed range 144-146, 430-434 and 435-438MHz.

(A) means VFO A receiver, (B) means VFO B receiver, (BC) means broadcast radio.

All stated specifications are subject to change without notice or obligation.



Applicable U.S. Military Specifications

Icom makes rugged products that have been tested to and passed the MIL-STD requirements and strict environmental standards for shock and vibration.

Icom, Icom Inc. and Icom logo are registered trademarks of Icom Incorporated (Japan) in Japan, the United States, the United Kingdom, Germany, France, Spain, Russia, Australia, New Zealand and/or other countries. Android and Google Play are registered trademarks or trademarks of Google Inc. The Bluetooth® word mark and logos are registered trademarks owned by Bluetooth SIG, Inc. and any use of such marks by Icom Inc. is under license. IOS is a trademark or registered trademark of Cisco in the U.S. and other countries and is used under license. App Store is a service mark of Apple Inc. Windows is either a registered trademark or a trademark of Microsoft Corporation in the United States and/or other countries. All other trademarks are the properties of their respective holders.

Icom Inc. 1-1-32, Kamiminami, Hirano-Ku, Osaka 547-0003, Japan Phone: +81 (06) 6793 5302 Fax: +81 (06) 6793 0013 www.icom.co.jp/world **Count on us!**

Icom America Inc.
12421 Willows Road NE,
Kirkland, WA 98034, U.S.A.
Phone: +1 (425) 454-8155
Fax: +1 (425) 454-1509
E-mail: sales@icomamerica.com
URL: <http://www.icomamerica.com>

Icom (Europe) GmbH
Communication Equipment
Auf der Krautweide 24
65812 Bad Soden am Taunus, Germany
Phone: +49 (6196) 76685-0
Fax: +49 (6196) 76685-50
E-mail: info@icom-europe.com
URL: <http://www.icomeurope.com>

Icom France s.a.s.
Zac de la Plaine,
1 Rue Brindejone des Moulinais, BP 45804,
31505 Toulouse Cedex 5, France
Phone: +33 (5) 61 36 03 03
Fax: +33 (5) 61 36 03 00
E-mail: icom@icom-france.com
URL: <http://www.icom-france.com>

Shanghai Icom Ltd.
No.101, Building 9, Caifuxingyuan Park,
No.188 Maoting Road, Chedun Town,
Songjiang District, Shanghai, 201611, China
Phone: +86 (021) 6153 2768
Fax: +86 (021) 5765 9987
E-mail: bjiacom@bjiacom.com
URL: <http://www.bjiacom.com>

Your local distributor/dealer:

Icom Canada
Glenwood Centre #150-6165
Highway 17A, Delta, B.C.,
V4K 5B8, Canada
Phone: +1 (604) 952-4266
Fax: +1 (604) 952-0090
E-mail: info@icomcanada.com
URL: <http://www.icomcanada.com>

Icom Spain S.L.
Ctra. Rubi, No. 88 "Edificio Can Castanyer"
Bajos A 08174, Sant Cugat del Valles,
Barcelona, Spain
Phone: +34 (93) 590 26 70
Fax: +34 (93) 589 04 46
E-mail: icom@icomspain.com
URL: <http://www.icomspain.com>

Icom (Australia) Pty. Ltd.
Unit 1 / 103 Garden Road,
Clayton, VIC 3168 Australia
Phone: +61 (03) 9549 7500
Fax: +61 (03) 9549 7505
E-mail: sales@icom.net.au
URL: <http://www.icom.net.au>

Icom Brazil
Rua Itororó, 444 Padre Eustáquio
Belo Horizonte MG,
CEP: 30720-450, Brazil
Phone: +55 (31) 3582 8847
Fax: +55 (31) 3582 8987
E-mail: sales@icombrasil.com

Icom (UK) Ltd.
Blacksloe House, Altira Park,
Herne Bay, Kent, CT6 6GZ, U.K.
Phone: +44 (0) 1227 741741
Fax: +44 (0) 1227 741742
E-mail: info@icomuk.co.uk
URL: <http://www.icomuk.co.uk>

Asia Icom Inc.
6F No. 68, Sec. 1 Cheng-Teh Road,
Taipei, Taiwan, R.O.C.
Phone: +886 (02) 2559 1899
Fax: +886 (02) 2559 1874
E-mail: info@asia-icom.com
URL: <http://www.asia-icom.com>